



Agilent Technologies

Innovating the HP Way

June 8, 2000

Dear Customer,

As of November 1, 1999, four of Hewlett-Packard's businesses, test and measurement, semiconductor products, health care solutions, and chemical analysis became a new company, Agilent Technologies. Now, many of your Hewlett-Packard products and services are in the care of Agilent Technologies.

At Agilent Technologies, we are working diligently to make this transition as smooth as possible for you. However, as a result of this transition, the products and related documentation contained in this shipment may be labeled with either the Hewlett-Packard name and logo, the Agilent Technologies name and logo, or a combination of both. Information in this package may refer to Hewlett-Packard (HP), but applies to your Agilent Technologies product. Hewlett-Packard and Agilent branded products with the same model number are interchangeable.

Whatever logo you see, the information, products, and services come from the same reliable source.

If you have questions about Agilent Technologies products and services, please visit our website at <http://www.agilent.com>.

Sincerely,

Rebranding Team

HP 8904A MULTIFUNCTION SYNTHESIZER

(Including Options 001, 002, 003, 004, 005 and 006)

Operation and Calibration Manual

SERIAL NUMBERS

This manual applies directly to instruments with serial numbers prefixed:

2712A and all *MAJOR* changes that apply to your instrument.

rev.01JUL91

For additional important information about serial numbers, refer to "INSTRUMENTS COVERED BY THIS MANUAL" in Section 1.

Third Edition

This material may be reproduced by or for the U.S. Government pursuant to the Copyright License under the clause at DFARS 52.227-7013 (APR 1988).

Copyright© HEWLETT-PACKARD COMPANY 1989
EAST 24001 MISSION AVENUE, TAF C-34, SPOKANE, WASHINGTON, U.S.A. 99220

Operation and Calibration Manual HP Part 08904-90007

Other Documents Available:

Operation and Application Guide HP Part 08904-90006

Service Manual HP Part 08904-90008

Microfiche Operation/Calibration Manual HP Part 08904-90019

Printed in U.S.A. : September 1992



1 Regulatory Information

(Updated March 1999)

Safety Considerations

GENERAL

This product and related documentation must be reviewed for familiarization with safety markings and instructions before operation.

This product has been designed and tested in accordance with *IEC Publication 1010*, "Safety Requirements for Electronic Measuring Apparatus," and has been supplied in a safe condition. This instruction documentation contains information and warnings which must be followed by the user to ensure safe operation and to maintain the product in a safe condition.

SAFETY EARTH GROUND

A uninterruptible safety earth ground must be provided from the main power source to the product input wiring terminals, power cord, or supplied power cord set.

SAFETY SYMBOLS



Indicates instrument damage can occur if indicated operating limits are exceeded.



Indicates hazardous voltages.



Indicates earth (ground) terminal

WARNING **A WARNING note denotes a hazard. It calls attention to a procedure, practice, or the like, which, if not correctly performed or adhered to, could result in personal injury. Do not proceed beyond a WARNING sign until the indicated conditions are fully understood and met.**

CAUTION A CAUTION note denotes a hazard. It calls attention to an operation procedure, practice, or the like, which, if not correctly performed or adhered to, could result in damage to or destruction of part or all of the product. Do not proceed beyond an CAUTION note until the indicated conditions are fully understood and met.

Safety Considerations for this Instrument

WARNING This product is a Safety Class I instrument (provided with a protective earthing ground incorporated in the power cord). The mains plug shall only be inserted in a socket outlet provided with a protective earth contact. Any interruption of the protective conductor inside or outside of the product is likely to make the product dangerous. Intentional interruption is prohibited.

Whenever it is likely that the protection has been impaired, the instrument must be made inoperative and be secured against any unintended operation.

If this instrument is to be energized via an auto transformer (for voltage reduction), make sure the common terminal is connected to the earth terminal of the power source.

If this product is not used as specified, the protection provided by the equipment could be impaired. This product must be used in a normal condition (in which all means for protection are intact) only.

No operator serviceable parts in this product. Refer servicing to qualified personnel. To prevent electrical shock, do not remove covers.

Service instructions are for use by qualified personnel only. To avoid electrical shock, do not perform any servicing unless you are qualified to do so.

The opening of covers or removal of parts is likely to expose dangerous voltages. Disconnect the product from all voltage sources while it is being opened.

The power cord is connected to internal capacitors that may remain live for 5 seconds after disconnecting the plug from its power supply.

For Continued protection against fire hazard, replace the line fuse(s) only with 250 V fuse(s) or the same current rating and type (for example, normal blow or time delay). Do not use repaired fuses or short circuited fuseholders.

Always use the three-prong ac power cord supplied with this product. Failure to ensure adequate earth grounding by not using this cord may cause product damage.

This product is designed for use in Installation Category II and Pollution Degree 2 per *IEC 1010* and *IEC 664* respectively. **FOR INDOOR USE ONLY.**

This product has autoranging line voltage input, be sure the supply voltage is within the specified range.

To prevent electrical shock, disconnect instrument from mains (line) before cleaning. Use a dry cloth or one slightly dampened with water to clean the external case parts. Do not attempt to clean internally.

Ventilation Requirements: When installing the product in a cabinet, the convection into and out of the product must not be restricted. The ambient temperature (outside the cabinet) must be less than the maximum operating temperature of the product by 4° C for every 100 watts dissipated in the cabinet. If the total power dissipated in the cabinet is greater than 800 watts, then forced convection must be used.

Product Markings

CE - the CE mark is a registered trademark of the European Community. A CE mark accompanied by a year indicated the year the design was proven.

CSA - the CSA mark is a registered trademark of the Canadian Standards Association.

CERTIFICATION

Hewlett-Packard Company certifies that this product met its published specifications at the time of shipment from the factory. Hewlett-Packard further certifies that its calibration measurements are traceable to the United States National Bureau of Standards, to the extent allowed by the Bureau's calibration facility, and to the calibration facilities of other International Standards Organization members.

WARRANTY

This Hewlett-Packard instrument product is warranted against defects in material and workmanship for a period of one year from date of shipment. During the warranty period, Hewlett-Packard Company will at its option, either repair or replace products which prove to be defective.

For warranty service or repair, this product must be returned to a service facility designated by HP. Buyer shall prepay shipping charges to HP and HP shall pay shipping charges to return the product to Buyer. However, Buyer shall pay all shipping charges, duties, and taxes for products returned to HP from another country.

HP warrants that its software and firmware designated by HP for use with an instrument will execute its programming instructions when properly installed on that instrument. HP does not warrant that the operation of the instrument, or software, or firmware will be uninterrupted or error free.

LIMITATION OF WARRANTY

The foregoing warranty shall not apply to defects resulting from improper or inadequate maintenance by Buyer, Buyer-supplied software or interfacing, unauthorized modification or misuse, operation outside of the environmental specifications for the product, or improper site preparation or maintenance.

NO OTHER WARRANTY IS EXPRESSED OR IMPLIED. HP SPECIFICALLY DISCLAIMS THE IMPLIED WARRANTIES OF MERCHANTABILITY AND FITNESS FOR A PARTICULAR PURPOSE.

EXCLUSIVE REMEDIES

THE REMEDIES PROVIDED HEREIN ARE BUYER'S SOLE AND EXCLUSIVE REMEDIES. HP SHALL NOT BE LIABLE FOR ANY DIRECT, INDIRECT, SPECIAL, INCIDENTAL, OR CONSEQUENTIAL DAMAGES, WHETHER BASED ON CONTRACT, TORT, OR ANY OTHER LEGAL THEORY.

ASSISTANCE

Product maintenance agreements and other customer assistance agreements are available for Hewlett-Packard products.

For any assistance, contact your nearest Hewlett-Packard Sales and Service Office. Addresses are provided at the back of this manual.

SAFETY CONSIDERATIONS

GENERAL

This product and related documentation must be reviewed for familiarization with safety markings and instructions before operation.

This product is a Safety Class I instrument (provided with a protective earth terminal).

BEFORE APPLYING POWER

Verify that the product is set to match the available line voltage and the correct fuse is installed.

SAFETY EARTH GROUND

An uninterruptible safety earth ground must be provided from the main power source to the product input wiring terminals, power cord, or supplied power cord set.

SAFETY SYMBOLS



Instruction manual symbol: the product will be marked with this symbol when it is necessary for the user to refer to the instruction manual (refer to Table of Contents).



Indicates hazardous voltages.



Indicates earth (ground) terminal.

WARNING

The WARNING sign denotes a hazard. It calls attention to a procedure, practice, or the like, which, if not correctly performed or adhered to, could result in personal injury. Do not proceed beyond a WARNING sign until the indicated conditions are fully understood and met.

CAUTION

The CAUTION sign denotes a hazard. It calls attention to an operating procedure, practice, or the like, which, if not correctly performed or adhered to, could result in damage to or destruction of part or all of the product. Do not proceed beyond a CAUTION sign until the indicated conditions are fully understood and met.

WARNING

Any interruption of the protective (grounding) conductor (inside or outside the instrument) or disconnecting the protective earth terminal will cause a potential shock hazard that could result in personal injury. (Grounding one conductor of a two conductor outlet is not sufficient protection).

Whenever it is likely that the protection has been impaired, the instrument must be made inoperative and be secured against any unintended operation.

If this instrument is to be energized via an autotransformer (for voltage reduction) make sure the common terminal is connected to the earth terminal of the power source.

Servicing instructions are for use by service-trained personnel only. To avoid dangerous electric shock, do not perform any servicing unless qualified to do so.

Adjustments described in the manual are performed with power supplied to the instrument while protective covers are removed. Energy available at many points may, if contacted, result in personal injury.

Capacitors inside the instrument may still be charged even if the instrument has been disconnected from its source of supply.

For continued protection against fire hazard, replace the line fuse(s) only with 250V fuse(s) of the same current rating and type (for example, normal blow, time delay, etc.). Do not use repaired fuses or short circuited fuseholders.

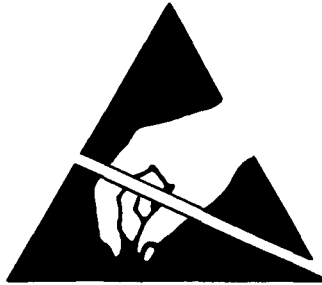

ATTENTION Static Sensitive Devices

This instrument was constructed in an ESD (electro-static discharge) protected environment. This is because most of the semiconductor devices used in this instrument are susceptible to damage by static discharge.

Depending on the magnitude of the charge, device substrates can be punctured or destroyed by contact or mere proximity of a static charge. The results can cause degradation of device performance, early failure, or immediate destruction.

These charges are generated in numerous ways such as simple contact, separation of materials, and normal motions of persons working with static sensitive devices.

When handling or servicing equipment containing static sensitive devices, adequate precautions must be taken to prevent device damage or destruction.

Only those who are thoroughly familiar with industry accepted techniques for handling static sensitive devices should attempt to service circuitry with these devices.

In all instances, measures must be taken to prevent static charge build-up on work surfaces and persons handling the devices.

For further information on ESD precautions, refer to "SPECIAL HANDLING CONSIDERATIONS FOR STATIC SENSITIVE DEVICES" in Section VIII Service Section.

VOLUME 1 CONTENTS

Section 1 - General Information



Introduction	1-1
Safety Considerations	1-2
Description	1-2
Specifications	1-3
Options	1-7
Mechanical and Document Options and Accessories	1-7
Electrical Options	1-8
Option 001:	1-8
Option 002:	1-8
Option 003:	1-8
Option 005:	1-9
Option 006:	1-9
Hewlett-Packard Interface Bus	1-9
Compatibility	1-9
Selecting the HP-IB Address	1-9
Accessories Supplied	1-9
Recommended Test Equipment	1-10
Documentation Updating	1-10
Serial Numbers	1-10
A Description of the Manual Update Packet	1-10
Signing Up for the Documentation Update Service	1-10

Section 2 - Installation

Introduction	2-1
Initial Inspection	2-1
Preparation For Use	2-1
Line Voltage Selection and Fuse Replacement	2-2
Power Cables	2-2
HP-IB Address Selection	2-2
Interconnection	2-4
Mating Connectors	2-4
Operating Environment	2-4
Bench Operation	2-4
Rack Mounting	2-4
Storage And Shipment	2-4
Environment	2-4
Packaging	2-4

Section 3 – Operation

Introduction 3-1

Block Diagram 3-2

 Functional Block Descriptions 3-3

How to Create and Output a Signal 3-4

Instrument Functions and Operating Considerations 3-6

 Standard Instrument: Creating a Simple Signal From Digital Data 3-6

 How the HP 8904A Generates a Signal 3-7

 Operating Considerations: All Instruments 3-7

 Abbreviated Channel A Specifications 3-8

 Option 001 - Three More Channels, Summation, Modulation, and Sequencing 3-9

 Expanded Capabilities for Option 001 3C-1

 Operating Considerations: Option 001 3-10

 Abbreviated Specifications: Option 001 3-10

 Option 002 - A Second Channel and Output 3-12

 Operating Considerations: Option 002 3-12

 Abbreviated Specifications: Option 002 3-12

 Option 003 - Frequency, Amplitude, and Phase Hopping 3-13

 Operating Considerations: Option 003 3-14

 Abbreviated Specifications: Option 003 3-14

Digital Port 3-15

 General Information 3-15

 Connector Functions 3-15

Remote Operation **HP-IB** 3-18

 General Information 3-18

 Programming Considerations 3-18

 HP-IB Compatibility 3-19

 HP-IB Code Listings for the HP 8904A 3-19

Status Byte 3-31

 General Information 3-31

 Using the Status Byte 3-31

 Error Isolation 3-32

Error Codes and Help Messages 3-34

Special Functions 3-37

 Introduction 3-37

 Special 0: Last State Recalled on Power Up 3-37

 Special 1: Disable Automatic Phase Reset 3-37

 Special 2: Disable Beeper 3-37

 Special 3: Reverse Modulating Waveforms 3-37

 Special 4: Disable Output Blanking 3-38

 Special 5: Floating Outputs on Power Up: 3-38

 Special 6: Enable Synchronous mode: 3-38

 Special 7: Configure as Master Controller: 3-38

Operating Technical Reference 3-39

 Waveform Jitter 3-39

 Fine Amplitude Resolution 3-39

 Filters 3-41

 Phase Resolution 3-42

 Phase Continuous Switching 3-42

Menu Map 3-44

 Selecting Menus 3-44

 Menu Changes When Using HP-IB Control 3-44

Hop RAM Sequencing 3C-1
 General Description 3C-1
 Detailed Operation 3C-1
 HP-IB Operation 3C-5
 FM Stereo Composite Generator 3C-7
 General Description 3C-7
 Detailed Operation 3C-7
 HP-IB Operation 3C-10
 Multi-Instrument Phase Synchronization 3A-1
 Introduction 3A-1
 General Description 3A-2
 Electrical Connections 3A-2
 Detailed Operating Instructions 3A-3
 HP-IB Operation 3A-7
 Specifications 3A-8
 High Power Balanced Output 3B-1
 Introduction 3B-1
 General Description 3B-1
 Operating Considerations 3B-1
 HP 8904A Option 006 Specifications 3B-2
 Expanded Capabilities for Option 001 3C-1

Section 4 – Performance Tests

Introduction 4-1
 Equipment Required 4-1
 Performance Test Record 4-1
 Calibration Cycle 4-1
 Basic Functional Checks 4-1
 Introduction 4-1
 Equipment Required 4-1
 Performance Test Record 4-1
 Calibration Cycle 4-1
 Basic Functional Checks 4-1
 Performance Test 1 — AC and DC Amplitude Accuracy 4-3
 Performance Test 2 — AC Amplitude Flatness 4-4
 Performance Test 3 — Spectral Purity 4-10
 Performance Test 4 — Phase Accuracy 4-14
 Performance Test 5 — Channel-to-Channel Phase Accuracy (Option 001) 4-17
 Performance Test 6 — Output 1-to-Output 2 Phase Accuracy (Option 002) 4-20
 Performance Test 7 — Tone Sequence Timing Accuracy (Option 001) 4-22
 Performance Test 8 — DTMF Sequence Timing Accuracy (Option 001) 4-26
 Performance Test 9 — Digital Sequence Period Accuracy (Option 001) 4-30

Section 5 – Adjustments

Introduction 5-1
Safety Considerations 5-1
Equipment Required 5-2
Post-Repair Tests, Adjustments, and Checks 5-2
Adjustment 1 — Output Gain and Offset 5-4
Adjustment 2 — Output Balance 5-6
Adjustment 3 — Output Gain (Option 006) 5-7
Adjustment 4 — Sharp Cutoff Low-Pass Filter 5-8
Adjustment 5 — Sine X/X Compensation 5-11
Adjustment 6 — Display Backlighting and Contrast 5-13
Adjustment 7 — Phase Synchronization (Option 005) 5-14

Section 1

GENERAL INFORMATION

1-1. INTRODUCTION

This manual contains information required to install, operate, test, and adjust the Hewlett-Packard Model 8904A Multifunction Synthesizer. The HP 8904A will generally be referred to as the Multifunction Synthesizer throughout this manual. This manual documents standard Multifunction Synthesizers and Multifunction Synthesizers supplied with four internal channels, Option 001, a second output port, Option 002, Hop Ram capabilities, Option 003, and rear panel outputs, Option 004.

Operating and reference information for other options is provided in the operating supplements at the end of section 3.

This section of the manual describes the instruments documented by this manual; it includes an instrument description, options, accessories, specifications, and other basic information. The other sections contain the following information:

Section 2, Installation: provides information about initial inspection, preparation for use, HP-IB address selection for remote operation, and storage and shipment.

Section 3, Operation: provides information about panel features and includes operator's checks, operating instructions for both local and remote operation, and operator's maintenance information. Operating information for options after Option 004 is provided in the form of separate supplements.

Section 4, Performance Tests: provides the information required to check performance of the instrument against the critical specifications listed in table 1-1.

Section 5, Adjustments: provides the information required to properly adjust the instrument.

One copy of the operating information is supplied with the Multifunction Synthesizer. An additional copy of the Operating Manual may be ordered separately through your nearest Hewlett-Packard office. Its part number is listed on the title page of this manual.

Also listed on the title page of this manual, below the manual part number, is a "Microfiche" part number. This number may be used to order 100 × 150 millimeter (4- × 6-inch) microfilm transparencies of this manual. Each microfiche contains up to 96 photo-duplicates of the manual's pages. The microfiche package also includes the latest Manual Updates information.

1-2. SAFETY CONSIDERATIONS

This product is a Safety Class I instrument, that is, one provided with a protective earth terminal. The Multifunction Synthesizer and all related documentation must be reviewed for familiarization with safety markings and instructions before operation. Refer to the Safety Considerations pages found at the beginning of this manual for a summary of the safety information. Safety information pertinent to the task at hand, that is, installation, operation, performance testing, and adjustments, is found throughout this manual.

1-3. DESCRIPTION

The HP 8904A is a Multifunction Frequency Synthesizer that produces six fundamental waveforms to create complex signals. The waveforms available are: dc, sine wave, ramp (sawtooth), triangle, square wave, and white (Gaussian) noise. The standard instrument is equipped with a single internal channel and one output. The addition of available options can provide: a second signal output port, three additional internal channels with modulation capabilities, and the ability to fast-hop between different phase, frequency, and amplitude settings. Multi-instrument synchronization and high level balanced output are also available.

A description of the available options is given in paragraphs 1-6 and 1-7.

1-4. SPECIFICATIONS

Table 1-1. HP 8904A Specifications (1 of 4)

HP 8904A SPECIFICATIONS

Specifications describe the instruments' warranted performance (50Ω output only unless noted) for automatic operation. Mathematically derived characteristics denote parameters which can be derived from specifications and knowledge of the digital generation methods used in the HP 8904A. Supplemental characteristics are intended to provide information useful in applying the instrument by giving typical, but not warranted performance parameters. These are noted as "typical", "normal", or "approximate".

Frequency

Range: Sine wave: 0 Hz to 600 kHz.
 Square, triangle, ramp: 0 Hz to 50 kHz.
Resolution: 0.1 Hz.
Accuracy: Internal 10 MHz timebase: ±50 ppm.
 External 10 MHz timebase: Same as accuracy and stability of external timebase.

AC amplitude (sine wave)

Range: 0 to 10V_{p-p} into a 50Ω load.
Resolution: 3½ digits.
Accuracy (amplitude >40 mV_{p-p} into 50Ω):
 1%, 0.1 Hz to 100 kHz.
 3%, 100 kHz to 600 kHz.
Flatness (amplitude >630 mV_{p-p} into 50Ω):
 ±0.1% (±0.009 dB), 0.1 Hz to 100 kHz.
 ±1.0% (±0.09 dB), 100 kHz to 600 kHz.

Spectral Purity (sine wave)

THD+N (including spurs, amplitude >50 mV rms into 50Ω):
 -63 dBc rms (0.07%), 20 Hz to 7.5 kHz, 30 kHz BW.
 -63 dBc rms (0.07%), 7.5 kHz to 20 kHz, 80 kHz BW.
 -55 dBc rms (0.18%), 20 kHz to 100 kHz, 750 kHz BW.

Phase (sine wave)

Range: 0 to 359.9°.
Resolution: 0.1° or 0.001 radians.
Increment accuracy (Relative to 0° for a fixed frequency):
 ±0.05°, 0.1 Hz to 100 kHz.

DC amplitude

Range: 0 to ±10V open circuit.
Resolution: 3½ digits.
Accuracy: ±20 mV or ±2.1%, whichever is greater.

Gaussian Noise

Spectral Characteristic: Equal energy per unit bandwidth ("white").
Amplitude range: 0 to 10V_{p-p} into a 50Ω load.¹
Resolution: 3½ digits.

Mathematically Derived Characteristics

Noise flatness (amplitude >100 mV_{p-p} into 50Ω):
 ±0.5 dB, 0.1 Hz to 100 kHz.
 ±1.0 dB, 100 kHz to 600 kHz.

$$^1 \text{ Noise Voltage} / \sqrt{\text{Hz}} \approx \frac{\text{Peak Voltage}}{(\text{Crest Factor}) \times 2 \times \sqrt{\text{Bandwidth}}}$$

$$\approx \frac{V_{pk}}{(4.4) \times (2) \times \sqrt{745 \text{ kHz}}}$$

Supplemental Characteristics

Number of channels: One standard; two with Option 002; four with Option 001.
Standard waveforms: Sine, square, triangle, ramp, dc, and Gaussian white noise.
AC amplitude accuracy:
 Typically: Square wave: <3% at 20 kHz.
 Triangle : <4%. at 20 kHz.
 Gaussian noise: <5%.
 Ramp: <7% at 20 kHz.
Square wave risetime/falltime: Typically <2.5 μs.
Spurious (typically the higher of):
 -50 dBc or 500 μV_{p-p}, 100 kHz to 600 kHz, 20 MHz BW.
Noise crest factor: Typically >4.4.
Switching speed (via HP-IB): Typically <25 ms.

Typical THD+Noise in 80 kHz measurement BW (above 20 kHz, in a 750 kHz measurement BW) at 5V_{p-p} into a 50Ω Load.

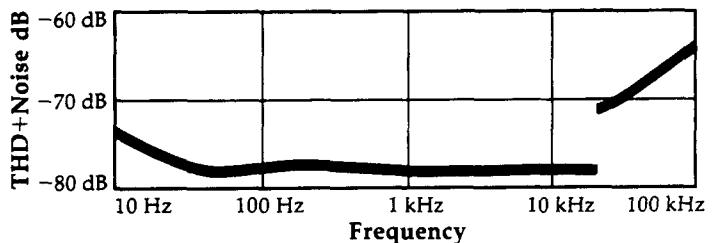

Typical Level Flatness (1 kHz ref.) at 5V_{p-p} into a 50Ω load.

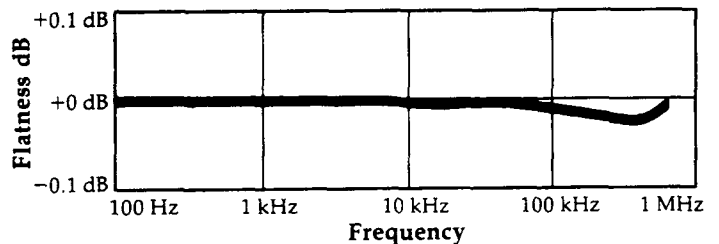

Typical SSB phase noise at 500 kHz.

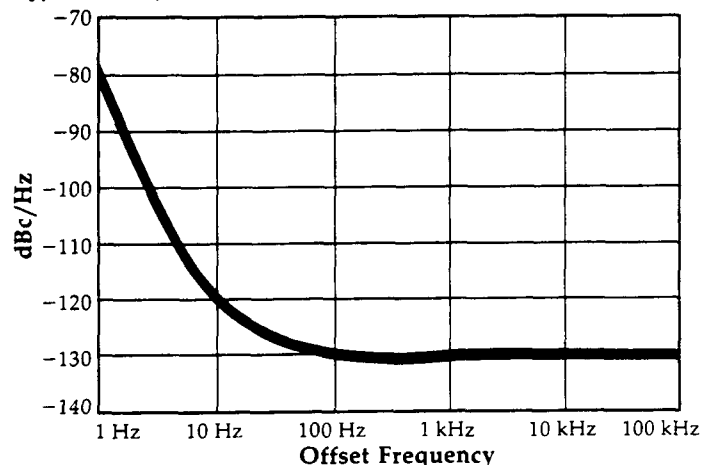

Table 1-1. HP 8904A Specifications (2 of 4)

OPTION 001 SPECIFICATIONS

(50Ω outputs only)

Modulation

Modulation for channel A ONLY, and specified for sinewave carrier and modulation. Internal channels B, C, and D can be used to either collectively modulate channel A with one modulation type, or can provide simultaneous modulation of channel A with any of the available modulation types. External modulation is NOT possible.

Amplitude Modulation (with Option 001)**Rate:** 0 Hz to 600 kHz.**Depth range:** 0% to 100% of carrier amplitude.**Resolution:** 0.1% of carrier amplitude.**Frequency Modulation (with Option 001)****Rate:** 0 Hz to 600 kHz.**Deviation range:** 0 Hz up to 600 kHz, however
 $F_{\text{carrier}} + F_{\text{deviation}} \leq 600 \text{ kHz}$.**Resolution:** 0.1 Hz or 3½ digits, whichever is less.**Phase Modulation (with Option 001)****Rate:** 0 Hz to 600 kHz.**Range:** 0° up to 179.9°/channel, however

$$F_{\text{carrier}} + \left\{ \frac{(F_{\text{mod}} \times \text{Dev}^\circ)}{57.3} \right\} \leq 600 \text{ kHz}$$

Resolution: 0.1° or 0.001 radians.**Pulse or DSBSC Modulation (with Option 001)****Rate:** 0 Hz to 50 kHz (up 600 kHz for DSBSC).**Summation (with Option 001)**

Two, three, or four channels may be summed into a single output. Two or three channels may be summed for modulation of channel A. All combinations of channels are acceptable, EXCEPT FOR: {A+C and B+D} or {A+D and B+C} at the same time.

Channel-to-channel phase accuracy (equal amplitude, sine wave signals summed into one output): ±0.1° or 30 ns, 0.1 Hz to 100 kHz, whichever is greater.

Mathematically Derived Characteristics

AM accuracy (the higher of): ±0.024% AM or ±0.20% of setting, up to 20 kHz modulation rate and 100 kHz carrier, 1% to 99% depth.

FM accuracy (the higher of): ±0.1 Hz or ±0.28% of setting, up to 20 kHz modulation rate, 20 kHz deviation, and where
 $F_{\text{carrier}} + F_{\text{deviation}} \leq 100 \text{ kHz}$.

φM accuracy (the higher of): ±0.1° or ±0.28% of setting, up to 20 kHz modulation rate, where:

$$\left\{ \frac{(F_{\text{mod}} \times \text{Dev}^\circ)}{57.3} \right\} \leq 20 \text{ kHz, and}$$

$$F_{\text{carrier}} + \left\{ \frac{(F_{\text{mod}} \times \text{Dev}^\circ)}{57.3} \right\} \leq 600 \text{ kHz}$$

DSBSC peak envelope accuracy: Same as amplitude accuracy, up to 20 kHz modulation rate.

Phase accuracy when one channel is used to modulate channel A (sine wave): ±0.15° or 30 ns, whichever is greater, 0.1 Hz to 100 kHz carrier frequency.

Supplemental Characteristics**VOR bearing accuracy:** Typically ±0.05°.**AM accuracy (at a 1 kHz rate and 600 kHz carrier):** Typically <±0.2%.**FM accuracy (at a 1 kHz rate, 20 kHz deviation, and 600 kHz carrier):** Typically <±0.2% of setting.**Pulse modulation level accuracy:** Typically 5% up to 20 kHz pulse rate.**DSBSC carrier suppression:** Typically >72 dB.**Intermodulation (two equal signal summed into one output):** Typically: <-70 dBc, for frequencies up to 100 kHz.

<-60 dBc, for frequencies 100 to 600 kHz.

Specifications for level accuracy, modulation accuracy, and spectral purity are all referenced to the peak of the composite signal less 3 dB. When signals are summed the specification for each individual signal is degraded by its amplitude relative to the peak of the composite signal.

FM Stereo Mode (with Option 001)**Test signal modes:** Left = Right, Left = -Right, Left only, and Right only.**Test tone frequency range:** 20 Hz to 15 kHz.**Composite signal level:** up to 10 V_{PP} into 50Ω.**Pilot tone level:** 0% to 100% of composite level.**Pilot tone level resolution:** 0.1% of composite level.**Pilot tone frequency range:** 0.1 Hz to 600 kHz (default frequency 19 kHz).**Pilot tone phase adjustment range:** 0.0 to 359.9°**Subcarrier frequency range:** 0.1 Hz to 600 kHz (default frequency 38 kHz).**Preemphasis:** 25 μsec, 50 μsec, and 75 μsec.**Supplemental Characteristics****FM stereo multiplex separation:**

L-R: typically > 65 dB, audio frequency 20 Hz to 15 kHz.

M-S: typically > 70 dB, audio frequency 20 Hz to 15 kHz.

Multiplex subcarrier suppression: typically > 70 dB**Tone Sequence (with Option 001)****Number of different frequencies:** 16 user definable tones each with an individual on time and off time.**On-time duration:** 0 ms, 0.80 ms to 655.35 ms.**Off-time duration:** 0 ms, 0.80 ms to 655.35 ms.

(Zero off time and zero on time not allowed)

Timing resolution: 0.01 ms (10 μs).**Timing accuracy:** ±0.02 ms (±20 μs).**Sequence length:** 750 tones, user definable from front panel or HP-IB programmable.**DTMF sequence (with Option 001)****Number of tone pairs:** 16 standard DTMF tone pairs (0-9, A-D, #, *). Frequencies per Bell Technical Reference Publication 48005.**On-time duration:** 0 ms, 1.00 to 655.35 ms.**Off-time duration:** 0 ms, 1.00 to 655.35 ms.

(Zero off time AND zero on time not allowed)

Timing resolution: 0.01 ms (10 μs).**Timing accuracy:** ±1 ms.**Sequence length:** 750 DTMF tones, user definable from front panel or HP-IB programmable.

Table 1-1. HP 8904A Specifications (3 of 4)**Digital Sequence (with Option 001)****User definable:**

- On level ($\pm 10V$ open circuit),
- Off level ($\pm 10V$ open circuit), and period.

Sequence entry: Binary, octal, or hexadecimal.

Sequence length: Up to 3000 bits.

Period duration: 0.10 ms to 655.35 ms.

Period resolution: 0.01 ms (10 μ s).

Period accuracy: ± 0.02 ms (± 20 μ s).

Control modes (applies to tone, DTMF and digital sequence modes): Manual sequence (allows stepping through sequence), single sequence, and continuously repeat sequence.

Sequence can also be triggered by external TTL pulse.

Hop Ram Sequence (with Option 001)

Number of different States: 16 user definable states each with an amplitude, frequency, and phase value.

Waveforms: Sine, square, ramp, triangle, dc, and white Gaussian noise.

Sequence entry: Binary, octal, or hexadecimal.

Sequence length: up to 3000 tones in binary mode (two states used), or up to 750 tones in hex mode (all 16 states used).

Sequence clock frequency range: 0.1 Hz to 10 kHz.

Sequence clock frequency resolution: 0.1 Hz.

Sequence burst range: 1 repetition up to 127.

Control modes: Manual sequence (allows stepping through sequence), burst sequence (1 to 127), and continuously repeat sequence. Sequence can be triggered by external TTL pulse.

OPTION 002 SPECIFICATIONS**(50 Ω outputs only)**

Output 1 to Output 2 phase accuracy (sine waves at the same frequency): $\pm 0.1^\circ$ or 30 ns, 0.1 Hz to 100 kHz, whichever is greater.

Supplemental Characteristics

Output 1 to Output 2 cross-talk (the higher of): Typically:

- 100 dB or 20 μ V_{p-p'}, 0.1 Hz to 20 kHz.
- 95 dB or 20 μ V_{p-p'}, 0.1 Hz to 100 kHz.
- 90 dB or 30 μ V_{p-p'}, 0.1 Hz to 600 kHz.

OPTION 003 SPECIFICATIONS**(50 Ω outputs only)**

Direct addressing of channel A: Up to 16 phase-frequency-amplitude states of channel A may be preset and directly addressed with four TTL-compatible inputs. Timing for fast hopping must be provided by an EXTERNAL source.

Digital modulation: By appropriately setting the 16 direct control registers, the HP 8904A may be used as a digital modulator. Examples of signals which can be generated with this technique include FSK or multilevel FM (up to 16 levels), BPSK, QPSK, and QAM.

Supplemental Characteristics**Switching Speed:**

- Via digital port: Typically <8 μ s, <20 μ s for full filter settling.
- Via HP-IB: Typically <8 ms.

Maximum switching rate (via digital control port): approximately 400 kHz.

Maximum allowable address skew (via digital port): 25 ns for valid results.

OPTION 005 SPECIFICATIONS**(50 Ω outputs only)**

Unit to unit phase accuracy: Additional 30 nsec error, 0.1 Hz to 100 kHz. (Total phase error between units is then the greater of ± 0.1 degree or 60 nsec, 0.1 Hz to 100 kHz.)

Maximum number of synchronized units: 8 units using low-loss power splitters (for a total of 16 phase related outputs if all units have Option 002).

Recommended power splitters:

- ≤ 4 units synchronized: Mini-Circuits model ZSC-4-3 or equivalent.
- ≤ 8 units synchronized: Mini-Circuits model ZFSC-8-1 or equivalent.

Supplemental Characteristics

Unit to unit phase accuracy: typically < 15 nsec additional error, 0.1 Hz to 100 kHz. (Total typical phase error between units is then the greater of ± 0.1 degree or 30 nsec, 0.1 Hz to 100 kHz.)

OPTION 006 SPECIFICATIONS**(Sine wave only)**

All specifications for the standard 50 Ω HP 8904A are degraded by the accuracy, flatness, and distortion specifications of the Option 006, 600 Ω transformer coupled output. Because the transformer output was designed for passing sinewaves only, all specifications apply to that waveform. The Option 006 output will not pass digital sequences available with Option 001. In addition, phase accuracy is degraded and therefore not specified for Option 006.

Output type: fully floating/balanced transformer coupled output.

Usable output frequency range: 30 Hz to 200 kHz.

AC amplitude (sine wave only)

Range: Open circuit: 0 to 20 Vrms.

600 Ω load: 0 to 10 Vrms.

150 Ω load: 0 to 4 Vrms.

50 Ω load: 0 to 1.5 Vrms.

Resolution: 3½ digits.

Accuracy (amplitude >40 mVrms into a balanced 600 Ω load):

6% (0.5 dB) 30 Hz to 20 kHz.

12% (1.0 dB) 30 Hz to 100 kHz.

Flatness (amplitude >40 mV rms into a balanced 600 Ω load, 1 kHz reference):

+ 0.15 dB, -0.15 dB, 30 Hz to 20 kHz.

+ 0.15 dB, -0.75 dB, 30 Hz to 100 kHz.

Spectral Purity (sine wave only)

THD + N (including spurs, amplitude 140 mVrms to 10 Vrms into a balanced 600 Ω load):

-46 dB (0.50%), 30 Hz to 300 Hz, 30 kHz BW, amplitude < 1 V_{rms} into a balanced 600 Ω load.

-60 dB (0.10%), 300 Hz to 7.5 kHz, 30 kHz BW.

-63 dB (0.07%), 7.5 kHz to 20 kHz, 80 kHz BW.

-55 dB (0.18%), 20 kHz to 100 kHz, 750 kHz BW.

Supplemental Characteristics

Balance: Typically >40 dB, 30 Hz to 50 kHz.

Output Impedance: Nominally 600 Ω at 1 kHz.

Flatness (amplitude >40 mV rms into a balanced 600 Ω load, 1 kHz reference): + 0.15 dB, -4.0 dB, 30 Hz to 200 kHz.

THD+N (including spurs, amplitude 140 mVrms to 1 Vrms into a balanced 600 Ω load):

< -50 dB (0.32%), 30 Hz to 300 Hz, 30 kHz BW.

Table 1-1. HP 8904A Specifications (4 of 4)**General****Store recall:** 35 nonvolatile**Output type:** Floating or grounded, HP-IB programmable.**Maximum float voltage (signal+float):** 10V peak maximum from high or low side to chassis ground.**Zero-crossing outputs (available in Channel Config mode only):** For each channel, a TTL-compatible zero-crossing output and polarity output are provided. The zero-crossing output pulses high for approximately 600 ns each time the channel phase goes through 0° or 180°. The polarity output is high for phases of 0° to 180°, low for 180° to 360°. These outputs do not reflect any user-specified phase offsets.**External timebase input:** 10 MHz accepted at a nominal level of 0.1 to 5V peak, automatic switching.**Timebase output:** Output level >0 dBm (0.3V peak) into a 50Ω load. Output signal will be the internal timebase unless an external timebase is connected to the external timebase input. When an external timebase is connected, it will be routed to the timebase output connector.**Temperature:** Operating, 0°C to 50°C;
Storage, -20°C to 70°C.**Humidity range:** 95% RH, 0°C to 40°C**Remote operation:** HP-IB. All functions except the line switch are remotely controllable.**HP-IB compatibility:** SH1, AH1, T6, TE0, L4, LE0, SR1, RL1, PP1, DC1, DT0, C0.**Power:** 100/120V (±10%); 48-440 Hz.
220/240V (±10%); 48-66 Hz.
80 VA maximum.**Weight:** Net 5.9 kg (12.8 lb.);
Shipping 13 kg (28.6 lb.).**Dimensions:** 133 mm H × 213 mm W × 513 mm D
(5.25 × 8.36 × 20.2 inches).**HP System II size:** 5¼ H × ½ MW × 20 D.**EMI:** Meets conducted and radiated interference of VDE 0871/6.78 class B (radiated at 10 meters). Meets MIL 461B conducted (CE03) and radiated (RE02) interference.**Supplemental Characteristics****Output impedance:** Typically 50Ω ±3%, 0.1 Hz to 600 kHz.

Note: Specifications for Option 005 and above are listed in the individual option supplements at the end of section 3. (3A, 3B, 3C,..ETC.)

1-5. OPTIONS

NOTE

Refer to pages 2 and 3 of table 1-1 for a complete listing of specifications for the electrical options.

Electrical and mechanical options are available and may have been ordered and received with the Multifunction Synthesizer. The options are listed in paragraphs 1-6 and 1-7. These options may be retrofitted to the instrument as follows:

To add Option 001, make arrangements with the nearest HP office to order HP part number 11816A and have the option installed.

To add Option 002, order HP part number 11817A. The kit can be installed by the user or at an HP Service Center.

To add Option 003, make arrangements with the nearest HP office to order HP part number 11818A and have the option installed.

To change an instrument to Option 004, refer to the HP 8904A Service Manual's section 7 *Option Conversions* section for the necessary part numbers and procedure.

Note: *Options 005 and 006 may only be retrofit on instruments with serial prefix 2948A and above. See section 7 of the HP 8904A Service Manual for more information.*

To add Option 005 (multi-instrument phase synchronization), order HP part number 11827A from your local HP sales office. This option is not compatible with Option 004.

To add Option 006 (balanced output), order HP part number 11837A from your local HP sales office. This option replaces the standard 50 Ω output of Output 1.

1-6. MECHANICAL AND DOCUMENT OPTIONS AND ACCESSORIES

Rear-Panel Outputs : Option 004. The RF Output Connectors are located on the rear panel. (Option 004 can not be installed with either Option 005, Phase Synchronization, or Option 006, High Power Balanced Output.)

Extra Operating and Service Manuals (1 each) : Option 910. An additional Operation and Calibration Manual and Service Manual are provided.

Add Service Manual : Option 915. The HP 8904A Service Manual provides the necessary procedures, parts lists, component locators, troubleshooting aids, and schematic diagrams, to enable qualified service personnel to repair an instrument. Information on retrofitting Options 002 and 004 is also given.

Front Handle Kit. Ease of handling is increased with the front-panel handles. Order HP part number 5061-9689.

Bail Handle Kit. The bail handle attaches to the front of the instrument to provide easy portability. Order HP part number 5061-9702.

Rack Flange Kit. This kit contains all necessary hardware and installation instructions for mounting the Multifunction Synthesizer in a rack with 482.5 mm (standard 19-inch) by 133 mm (5.25 inch) spacing. One side of the instrument mounts directly to the rack, an offset panel encloses the other side of the opening. Order HP part number 5061-9657.

For more information on available mounting hardware and cabinet options, refer to the latest available Hewlett-Packard products catalog.

1-7. ELECTRICAL OPTIONS

Option 001:

Channel Configuration Mode Enhancements. Three additional individually-addressable internal channels are added for a total of 4 channels. The frequency, phase, amplitude, waveform, and destination of each channel are individually defined by the user to provide the maximum flexibility of the instrument. These additional channels provide the following functions:

Modulation of Channel A. Channels B, C, and D can be used to generate up to 3 independent forms of modulation at the same time, or they can be summed prior to modulating channel A to generate many complex waveforms. The allowable modulation types are: AM, FM, Φ M, DSBSC (Double Side Band Suppressed Carrier), and pulse.

Channel Summation. Two, three, or four channels may be summed into a single output. Two or three channels may be summed for modulation of channel A.

Tone Sequence Mode. Sixteen user-defined frequencies can be programmed into sequences. Both the on and off times of each tone can be adjusted.

Dual Tone Multi Frequency (DTMF) Sequence Mode. The 16 standard Bell Telephone touch-tone signals commonly used in communications signaling can be output. Both the on and off times of each tone can be user-defined.

Digital Sequence Mode. Digital data strings can be used in sequences to provide a series of signaling events. Bit period and on/off levels can be user-defined.

Note: *Hop RAM Sequence Mode and FM Stereo Composite Generator functions are only available in Option 001 instruments with serial prefixes 2948A and above. Detailed operating information for these functions is provided in section 3C.*

Hop RAM Sequence Mode. Up to 16 different frequency, amplitude, and phase settings can be preset. Sequences of up to 750 tones can be built using all 16 states. Sequences of up to 3000 tones can be built using only two states. Sequences can be output from 1 to 127 times using a 'burst' function. Timing is provided internally for the sequences and is adjustable for precise baud rates.

FM Stereo Composite Generator. A flexible FM stereo encoder function is added for testing broadcast receivers. The audio test tone frequency, composite signal level, test signal mode, pilot on/off, pilot amplitude, pilot frequency, pilot phase, carrier frequency, and preemphasis are adjustable.

Option 002:

A second internal channel and output port are added, allowing two independent, simultaneously-operating signals.

Option 003:

The DIGITAL PORT on the rear panel of the instrument allows direct TTL- input of control data to perform the following functions:

Hop Ram. Up to 16 phase, frequency, and amplitude states of channel A may be preset and directly addressed. Timing for fast hopping must be provided by an external source.

Digital Modulation. Appropriately setting the 16 direct control registers allows the instrument to be used as a digital modulator. Examples of signals which can be generated with this technique include FSK or multilevel FM (up to 16 levels), BPSK, QPSK, and QAM.

Option 005:

Up to eight instruments may be connected together to form a “master/slave” relationship between the instruments. One instrument provides the timing signals for the other seven. (If all eight instruments are equipped with Options 002 and 005, a total of 16 outputs can be synchronized. If eight instrument have Options 001 and 005, 32 internal channels can be synchronized.) Detailed operating information for this function is provided in the *HP 8904A Option 005* supplement in section 3A.

Option 006:

A full-floating, balanced, transformer-coupled output is provided for Output 1. Output impedance is 600Ω instead of the usual 50Ω . Maximum output level is increased to 20 V rms into an open circuit, or 10 V rms into a 600Ω load. Detailed operating information for this function is provided in the *HP 8904A Option 006* supplement in section 3B.

1-8. HEWLETT-PACKARD INTERFACE BUS

Compatibility

The Multifunction Synthesizer has an HP-IB interface and can be used with any HP-IB computing controller or computer for automatic system applications. The Multifunction Synthesizer is fully programmable via the HP Interface Bus. The Multifunction Synthesizer's complete compatibility with HP-IB is defined by the following list of interface functions: SH1, AH1, T6, TE0, L4, LE0, SR1, RL1, PP1, DC1, DT0, and C0. The Multifunction Synthesizer interfaces with the bus via open collector TTL circuitry. An explanation of the compatibility codes can be found in the IEEE Standard 488 and the identical ANSI Standard MC1.1.

For more detailed information relating to programmable control of the Multifunction Synthesizer, refer to Remote Operation, Hewlett-Packard Interface Bus in section 3 of this manual. A booklet has been prepared entitled “Tutorial Description of the Hewlett-Packard Interface Bus” to provide a complete overview of the theory and operation of HP-IB. To receive this booklet, order HP part number 5952-0156.

Selecting the HP-IB Address

The Multifunction Synthesizer's HP-IB address is set by direct front-panel entry and is stored in non-volatile memory. The instrument is delivered with address 26 already set, but may be easily changed to any address desired from 00 to 30 (decimal). For information on changing the HP-IB address, refer to paragraph 2-3 *PREPARATION FOR USE, HP-IB Address Selection*.

1-9. ACCESSORIES SUPPLIED

The power cable and fuse supplied for the Multifunction Synthesizer are selected at the factory according to the Mains voltage available in the country of destination. For the part number and rating of the fuse, refer to table 2-1. For the part numbers of the Power Cables and Mains Plugs available, refer to table 2-2. Two BNC-to-Banana Plug adapters (HP Part 1250-2164) are shipped with each standard instrument; four adapters are shipped with an Option 002 instrument.

1-10. RECOMMENDED TEST EQUIPMENT

Table 2-1 lists the test equipment required for performance testing, adjusting, and servicing the Multifunction Synthesizer. The Critical Specifications column describes the essential requirements for each piece of test equipment. Other equipment can be substituted if it meets or exceeds these critical specifications.

1-11. DOCUMENTATION UPDATING

Serial Numbers

Attached to the instrument is a serial number plate. The serial number is in the form 1234A00123. The first four digits and the letter are the serial prefix. The last five digits form the sequential suffix that is unique to each instrument. The contents of these manuals apply directly to instruments having the same serial number prefix(es) as listed under SERIAL NUMBERS on the respective manual title pages.

For information concerning a serial number prefix not listed on the title page or in the Manual Update packets, contact your nearest Hewlett-Packard office.

An instrument manufactured after the printing of these manuals may have a serial number prefix that is not listed on the manual title page. Having a serial number prefix that is greater than that shown on the title page indicates that the instrument is slightly different from those documented in the manual. In this case, your manual is provided with updating information to make it as current as possible. This updating information includes any hardware or software changes that have occurred as well as corrections to the documentation.

A Description of the Manual Update Packet

A *Manual Update* packet consists of replacement and addition pages which should be incorporated in your manual to bring it up to date.

Signing Up for the Documentation Update Service

Hewlett-Packard offers a Documentation Update Service that will provide you with further updates and changes as they become available. If you have not received update information that matches the serial number of your instrument, you can receive this information through the Update Service.

If you operate or service instruments with different serial prefixes, we strongly recommend that you join this service immediately to ensure that your manual is kept current. For more information, refer to the Documentation Update Service reply card included in this manual or contact:

Hewlett-Packard Company
Learning Products Department
24001 E. Mission—TAF C-34
Spokane, WA 99220
(509) 921-4001

Also, if you join the update service, you can indicate whether you choose to be contacted in the future about the quality of the documentation you receive. We are trying to improve the documentation we provide and periodically survey customers as to their expectations of the manuals.

Table 1-2. Recommended Test Equipment (1 of 2)

Instrument Type	Critical Specifications	Suggested Model	Use*
Audio Analyzer	Fundamental Frequency Range: 20 Hz to 100 kHz Distortion Range: -70 dB Distortion Accuracy: ± 2 dB Low-Pass Filters: 30 and 80 kHz	HP 8903B	P
Audio Spectrum Analyzer	Frequency Range: 100 to 5000 Hz Input Level: 5 Vrms Display Range: 60 dB	HP 3561A or HP 3580A	P
Digital Multimeter	DC Range: 0 to 50V DC Accuracy: $\pm 0.2\%$, 1 to 15 Vdc; ± 2 mV, 10 to 1000 mVdc AC Range: 0 to 100V AC Accuracy: $\pm 1\%$ Ohms Range: 0 to 1 k Ω Ohms Accuracy: $\pm 0.2\%$	HP 3478A	P, A
Frequency Counter	Frequency Range: 10 MHz Absolute Accuracy: ± 5 ppm	HP 5314A	P
Network Analyzer	Analyzer Frequency Range: 0 to 5 MHz Display Range: 80 dB Source Frequency Range: 0 to 5 MHz Input and Output Impedance: 50 Ω	HP 3577A	A
Oscilloscope	3 dB Bandwidth: 1 MHz Sensitivity: 5 mV per division Input Impedance: 1 M Ω and 50 Ω Triggering: External and Internal Two Channels; A vs. B Display	HP 1740A or Tektronix 2235	P, A
Synthesized Signal Generator	Frequency Range: 1 kHz to 1 MHz Output Level: 1 Vrms Output Impedance: 50 Ω Variable Phase Range: 360 deg Variable Phase Resolution: 0.1 deg	HP 3325A Option 001	P
*P=Performance Tests; A=Adjustments			

Table 1-2. Recommended Test Equipment (2 of 2)

Instrument Type	Critical Specifications	Suggested Model	Use*
Thermal Converter	Level Range: 1V Frequency Range: 20 Hz to 600 kHz Flatness: $\pm 0.03\%$ Input Impedance: 50Ω	HP 11050A or Labs 1395A-1	P, A
Multifunction Synthesizer**	All specifications must match the HP 8904A Opt 005.	HP 8904A Option 005	P
Power Splitter** (2 required)	Four way Impedance: 50Ω Path Loss: 1 dB Frequency Range: >50 MHz	Mini-Circuits ZSC-4-3	P, A
<p>*P=Performance Tests; A=Adjustments **Used only to test HP 8904A Option 005.</p>			

Section 2 INSTALLATION

2-1. INTRODUCTION

This section provides the information needed to install the HP 8904A Multifunction Synthesizer. Included is information pertinent to initial inspection, power requirements, line voltage and fuse selection, power cables, HP-IB address selection, interconnection, mating connectors, operating environment, instrument mounting, storage, and shipment.

2-2. INITIAL INSPECTION

WARNING

To avoid hazardous electrical shock, do not perform electrical tests when there are any signs of shipping damage to any portion of the outer enclosure (covers and panels).

Inspect the shipping container for damage. If the shipping container or cushioning material is damaged, it should be kept until the contents of the shipment have been checked for completeness and the instrument has been checked mechanically and electrically. Procedures for checking electrical performance are given in Section 4. If the contents are incomplete, if there is mechanical damage or defect or if the instrument does not pass the electrical performance test, notify the nearest Hewlett-Packard office. If the shipping container is damaged, or the cushioning material shows signs of stress, notify the carrier as well as the Hewlett-Packard office. Keep the shipping materials for the carrier's inspection.

2-3. PREPARATION FOR USE

The Multifunction Synthesizer requires a power source of 100 to 120Vac ($\pm 10\%$) at 48 to 440 Hz, or 220 to 240Vac ($\pm 10\%$) at 48 to 66 Hz. Power consumption is 80 VA maximum.

WARNING

This is a Safety Class I product (i.e., provided with a protective earth terminal). An uninterruptible safety earth ground must be provided from the Mains power source to the product input wiring terminals, power cord, or supplied power cord set. Whenever it is likely that the protection has been impaired, the instrument must be made inoperative and be secured against any unintended operation.

If this instrument is to be energized via an external autotransformer for voltage reduction, make sure that the common terminal is connected to the earthed pole of the power source.

Line Voltage Selection and Fuse Replacement

CAUTION

BEFORE PLUGGING THIS INSTRUMENT into the Mains (line) voltage, be sure the correct voltage has been selected.

A rear-panel switch permits operation from 100 to 120Vac when used in the 115V position, or from 220 to 240Vac when used in the 230V position. The number visible on the switch indicates which range of line voltage to supply to the instrument. Verify that the line voltage selection switch is matched to the power source. Table 2-1 lists the ratings and the HP part number for the replaceable fuse.

One fuse is supplied with each instrument. It has the proper rating for 100, 120, 220, or 240Vac operation.

The fuse is installed in the instrument at the time of shipment. The position of the line voltage selection switch is set according to the line voltage specified by the customer. If the voltage is not specified, the selection switch will be set according to the country of destination.

WARNING

For protection against fire hazard, the line fuse should only be a 250V fuse with the correct current rating.

Table 2-1. Line Fuse Rating and HP Part Number

Line Voltage	Rating	Part Number
100, 120, 220, 240 Vac	3.0A, 250V	2110-0003





Power Cables

WARNING

BEFORE CONNECTING THIS INSTRUMENT, the protective earth terminal of the instrument must be connected to the protective conductor of the (Mains) power cord. The Mains plug shall only be inserted in a socket outlet provided with a protective earth contact. The protective action must not be negated by the use of an extension cord (power cable) without a protective conductor (grounding). Grounding one conductor of a two-conductor outlet is not sufficient protection.

This instrument is equipped with a three-wire power cable. When connected to an appropriate ac power receptacle, this cable grounds the instrument cabinet. The type of power cable plug shipped with each instrument depends on the country of destination. Refer to Table 2-2 for the part numbers of the power cables and Mains plugs available.

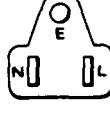
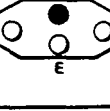
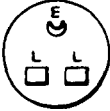
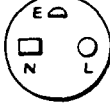
Table 2-2. Power Cable and Mains Plug Part Numbers

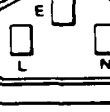
Plug Type	Cable HP Part Number	C D	Plug Description	Cable Length (inches)	Cable Color	For Use In Country
250V 	8120-1351 8120-1703	0 4	90°/STR BS1363A* 90°/90°	90 90	Mint Gray Mint Gray	United Kingdom, Cyprus, Nigeria, Rhodesia, Singapore
250V 	8120-1369 8120-0696	0 4	STR/STR NZSS198/ASC112* STR/90°	79 80	Gray Gray	Australia, New Zealand
250V 	8120-1689 8120-1692	7 2	STR/STR* STR/90°	79 79	Mint Gray Mint Gray	East and West Europe, Saudi Arabia, Egypt, (unpolarized in many nations)
125V 	8120-1378 8120-1521	1 6	STR/STR NEMA5-15P* STR/90°	80 80	Jade Gray Jade Gray	United States, Canada, Mexico, Phillipines, Taiwan
100V (Same plug as above)	8120-1751	1	STR/STR	90	Jade Gray	U.S./Canada
	8120-4753 8120-4754	2 3	STR/STR STR/90°	90 90	Dark Gray Dark Gray	Japan only Japan only
250V 	8120-2104	3	STR/STR SEV1011 1959-24507 Type 12	79	Gray	Switzerland
	8120-2296	4	STR/90°	79	Gray	
	8120-3997	4	STR/90°	177	Gray	
250V 	8120-0698	6	STR/STR NEMA6-15P	90	Black	United States, Canada
250V 	8120-2956 8120-2957 8120-3997	3 4 4	90°/STR 90°/90° STR/STR	79	Gray	Denmark
250V 	8120-4211 8120-4600	7 8	STR/STR*IEC83-B1 STR/90°	79 79	Black Gray	South Africa, India
250V 	8120-1860 8120-1575 8120-2191 8120-4379	6 0 8 8	STR/STR*CEE22-V1 (Systems Cabinet Use) STR/STR STR/90° 90°/90°	59 31 59 80	Jade Gray Jade Gray Jade Gray Jade Gray	

* Part number shown for plug is industry identifier for plug only. Number shown for cable is HP Part Number for complete cable including plug. E = Earth Ground; L = Line; N = Neutral; STR = Straight

HP-IB Address Selection

The Multifunction Synthesizer is both a listener and a talker. Any address from 00 to 30 (decimal) can be used, however, address 21 should not normally be used since it is the address normally reserved for the internal controller. HP-IB addresses greater than 30 are invalid and will not be allowed to be stored in the instrument. The instrument will normally be delivered with the HP-IB address set to 26.

The HP-IB address can only be changed while the instrument is on, and by using direct front panel entry. To read or change the HP-IB address, key-in **SHIFT ADRS**. The front panel will display the current address and allow the entry of a new address. Enter a new HP-IB address by keying-in the new address and pushing the **ENTER** key.

Interconnection

Interconnection data for the Hewlett-Packard Interface Bus is provided in Figure 2-1.

Mating Connectors

Coaxial Connectors. Coaxial mating connectors used with the Multifunction Synthesizer should be 50-ohm BNC male connectors that are compatible with those specified in US MIL-C-39012.

Interface Connector. HP-IB mating connector is shown in Figure 2-1. Note that the two securing screws are metric.

DIGITAL PORT Connector. This is a 15 circuit, 15 pin, type "D" subminiature connector. Corresponding mating connector is HP part 1251-0221 or TRW part DAM15P. (The Hop Ram functions for the port only operate on instruments equipped with Option 003 - Hop Ram).

Operating Environment

The operating environment should be within the following limitations:

- Temperature 0° C to + 50° C
- Humidity < 95% relative at 40° C
- Altitude..... < 4570 meters (15,000 feet)

Bench Operation

The instrument cabinet has plastic feet and a foldaway tilt stand for convenience in bench operation. (The plastic feet are shaped to ensure self-alignment of instruments when they are stacked.) The tilt stand raises the front of the Multifunction Synthesizer for easier viewing of the front panel.

Rack Mounting

Rack mounting information is provided with the rack mounting kits. If a kit was not ordered with the Multifunction Synthesizer as an option, it may be ordered through the nearest Hewlett-Packard office.

2-4. STORAGE AND SHIPMENT

Environment

The instrument should be stored in a clean, dry environment. The following environmental limitations apply to both storage and shipment.

Temperature	-20° C to + 75° C
Humidity	< 95% relative at 40° C
Altitude.....	<15 300 meters (50,000 feet)

Packaging

Original Packaging. Containers and materials identical to those used in factory packaging are available through Hewlett-Packard offices. If the instrument is being returned to Hewlett-Packard for servicing, attach a tag indicating the type of service required, return address, model number, and full serial number. Also, mark the container **FRAGILE** to assure careful handling. In any correspondence, refer to the instrument by model number and full serial number.

Other Packaging. The following general instructions should be used for repackaging with commercially available materials.

- a. Wrap the instrument in heavy paper or plastic. (If shipping to a Hewlett-Packard office or service center, attach a tag indicating the type of service required, return address, model number, and full serial number.)
- b. Use a strong shipping container. A double-wall carton made of 2.4 MPa (350 psi) test material is adequate.
- c. Use enough shock-absorbing material (75 to 100 millimeter layer; 3 to 4 inches) around all sides of the instrument to provide a firm cushion and to prevent movement in the container. Protect the front-panel with cardboard.
- d. Seal the shipping container securely.
- e. Mark the shipping container **FRAGILE** to assure careful handling.

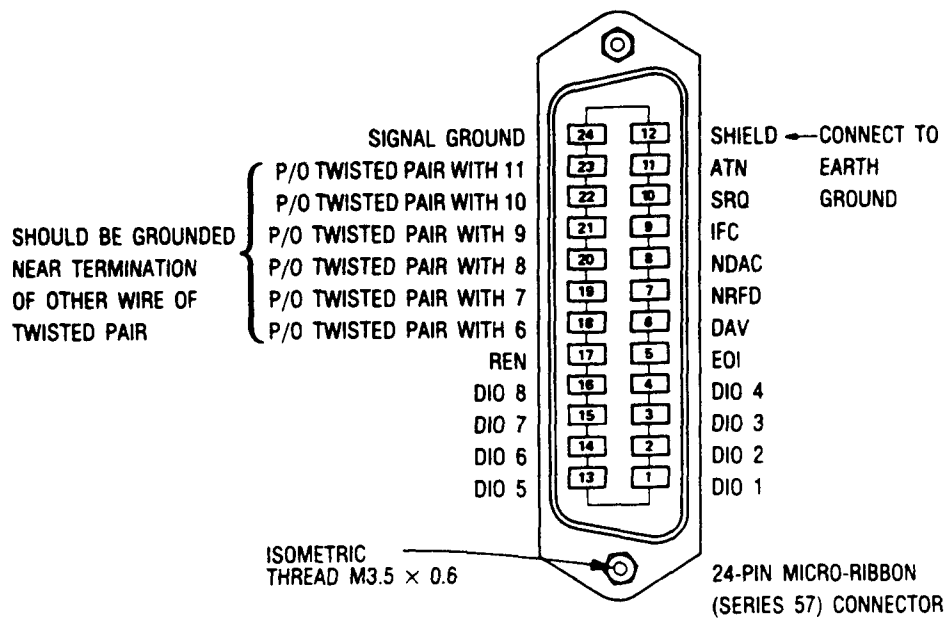

Logic Levels

The Hewlett-Packard Interface Bus logic levels are TTL compatible, that is, the true (1) state is 0.0 Vdc to +0.4 Vdc and the false (0) state is 2.5 Vdc to +5 Vdc.

Programming and Output Data Format

Refer to Section 3 "Operation".

Mating Connector

HP 1251-0293; Amphenol 57-30240

Mating Cables Available

HP 10833A, 1 meter (3.3 ft.), HP 10833B 2 meters (6.6 ft.)
 HP 10833C 4 meters (13.2 ft.), HP 10833D, 0.5 meters (1.6 ft.)

Cabling Restrictions

1. A Hewlett-Packard Interface Bus system may contain no more than 2 meters (6.6 ft.) of connecting cable per instrument.
2. The maximum accumulative length of connecting cable for any Hewlett-Packard Interface Bus system is 20 meters (65.6 ft.).

Figure 2-1. Hewlett-Packard Interface Bus Connections

Section 3 OPERATION

3-1. INTRODUCTION

This section provides reference information for operating the HP 8904A Multifunction Synthesizer by manual or remote control. Information is given that helps you understand how the HP 8904A generates signals, and what you must know in order to create the signal you need.

'Button-by-button' and tutorial operating instructions for options 001, 002, and 003 are provided in the HP 8904A *Operation and Application* guide.

Note: *Option 001 capabilities have been expanded for instruments with serial prefix 2948A and above. Detailed operating and HP-IB information for these functions is provided in section 3C.*

Operating information for options 005 and 006 is provided in sections 3A and 3B.

The capabilities and specifications for the various options, HP-IB operation and codes, and other reference information is given under the following headings:

Instrument Block Diagram – provides an overview of the main functional blocks that comprise the HP 8904A.

How to Create and Output a Signal – illustrates how the different signal controls are implemented in the instrument and the control sequences used to create and output a signal.

Instrument Functions and Operating Considerations – describes the capabilities and operating considerations for a standard HP 8904A and the various options.

Digital Port – identifies the connections for this port and describes how it is used for operations such as fast hopping Option 003 equipped instruments.

Remote Operation – lists the HP-IB codes and capabilities implemented in the HP 8904A. Programming examples are given to illustrate the usage of some of the codes listed for each option.

Status Byte – discusses the purpose and use of the Status Byte. Programming examples are given to help you further understand and apply the information.

Error Codes and Help Messages – lists the various error codes and their meanings.

Special Functions – describes the special functions in the HP 8904A and how to program them.

Operating Technical Reference – provides detailed technical descriptions for a variety of topics related to operating the HP 8904A.

Menu Map – illustrates the organization of the various menus used in the HP 8904A and what keystrokes are used to access each of the menus. This fold-out page is designed to be viewed as you refer to the other material that is listed earlier in the section, letting you see a 'before and after' relationship between the menus and the related operations.

3-2. BLOCK DIAGRAM

The block diagram below illustrates the main functional blocks that comprise the HP 8904A. The capabilities of your instrument are dependant upon the options you have ordered. By understanding how the different options integrate with the rest of the instrument, you can quickly learn to create almost any signal you need.

For more information on the capabilities and operation of standard and optional instrument functions, refer to the detailed information following later in Section 3. Step-by-step operations for each option are included in the HP 8904A Multifunction Synthesizer *Basic Operation and Application* guide.

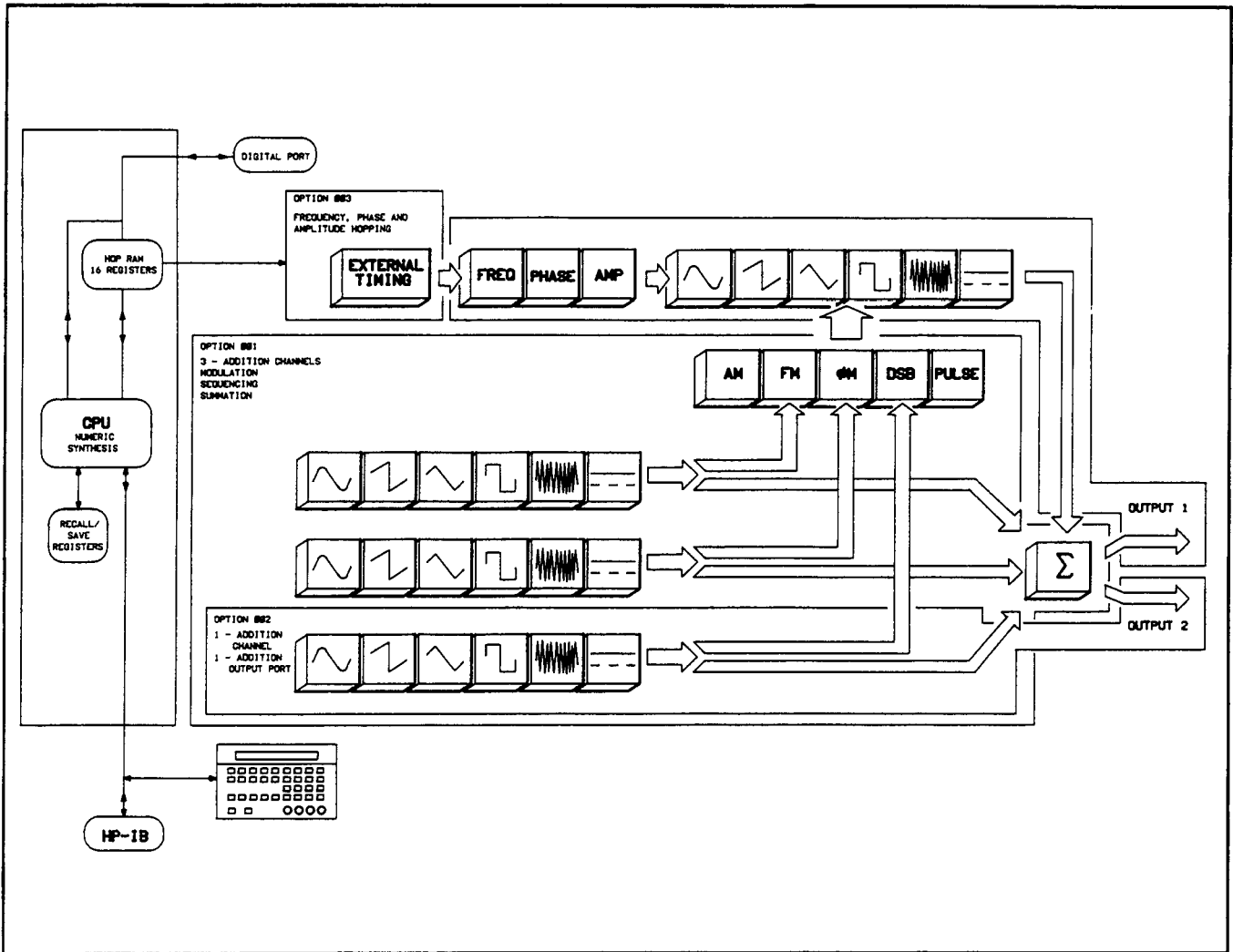

Figure 3-1. HP 8904A Functional Blocks

Functional Block Descriptions

CPU: The Central Processing Unit consists of the microprocessor, Numeric Synthesis IC, and the associated ROM and RAM memories needed to store the instruments operating system and configuration settings. Interfacing between the HP-IB, Digital Port, and keyboard inputs is performed here.

Recall/Save Registers: This is a special section of RAM that is used to store instrument settings for later retrieval. A battery backup is provided so that the information in this memory is not lost if power is disconnected from the instrument.

Hop RAM Registers: This is the area of RAM where the 16 Hop RAM settings are stored for Option 003 equipped instruments.

Digital Port: The Digital Port connector on the rear panel of the HP 8904A is used primarily for address selection and timing of the Hop RAM settings. Fast hopping is achieved by using an external timing signal. The usage of this connector is discussed later in Section 3, along with more details on using Option 003.

Keyboard: All of the front panel controls.

HP-IB: This is the connector for the IEEE-488 compatible Hewlett-Packard Interface Bus. Except for the Line switch, all functions that can be selected using the front panel controls can be selected remotely over this control bus. Refer to the *Remote Control* information described later in Section 3 for more information regarding the use of this connection. Example programs for using the HP-IB are also provided.

Standard Single Channel: This block contains the one standard channel included with every instrument (channel A). You can control the Frequency, Phase, Amplitude, and Waveform of the signal.

Option 001: Three more channels are added. You may sum channels together in various combinations. (Refer to the *Option 001 Specifications* listed in Section 1 for more information on summation.) Modulation of channel A is provided using one or more of the other channels as a modulating source. Sequencing of Tone, DTMF (Dual Tone Multi Frequency), and Digital signals is provided.

Option 002: A second channel (channel B) and a second instrument output port are added. The two channels operate independent of each other; however, the phase relationship between the two signals can be varied by adjusting either channel.

Option 003: This feature provides the ability to hop between 16 different channel A setups. Frequency, Amplitude, and Phase can all be hopped simultaneously or independently. The timing signal and address selection for accomplishing the hopping is input via the Digital Port. (See *Digital Port* discussed earlier in this section.)

3-3. HOW TO CREATE AND OUTPUT A SIGNAL

Each channel available in your HP 8904A is set to default values each time the instrument is powered up. You must specify any signal parameters you need to change in the Channel Configuration Mode before you can output the desired signal. To enter the Channel Configuration Mode, press the **f1** key from the Main Selection Level.

You can then store the instrument settings you have specified by using the **SAVE** and **RECALL** keys to access the storage registers.

Most of the signal parameters can be entered in any order. (Destination, Frequency, Phase, Amplitude; Destination, Amplitude, Frequency, Phase.. etc.) However, you should always set the Destination (**DESTN**) before specifying the Amplitude (**AMPTD**); since the Amplitude setting is always set to zero (0) when the Destination is changed. If you turn the Destination Off for any channel, you can not change the amplitude for that channel until it is turned back On.

<u>Parameter</u>	⇒	<u>Value(Example)</u>	⇒	<u>Terminator</u>
FREQ (frequency)		≥ 0 (0, 1.3, 24...)		Hz, kHz
DESTN (destination) ch A		1, 2, or OFF		(none)
DESTN (destination) ch B,C,D		1, 2, AM, FM, φM, DSB, PULSE, OFF		(none)
AMPTD (amplitude) AC		≥ 0 (3, 2.18, .01...)		μV, mV, V
AMPTD (amplitude) DC		± (-1.1, -9, 3.07...)		μV, mV, V
AMPTD (amplitude) ch B,C,D Modulating ch A. Use the appropriate Terminator for each modulation type.		≥ 0 (1, 34, .07...)		%, Hz, kHz, deg, μV, mV, V
PHASE (phase)		≥ 0 (0, 1.3, .6...)		rad, deg
WAVE/FORM (waveform)		(none)		~ , ~ , ~ , ~ , NOISE, ==
FLOAT (float)		1 or 2		ON or OFF
FILTER (filter)		1 or 2		Low Overshoot or Sharp Cutoff
OUTPUT (output)		1 or 2		ON or OFF

For step-by-step operation examples, refer to the HP 8904A Multifunction Synthesizer *Basic Operation and Application* guide.

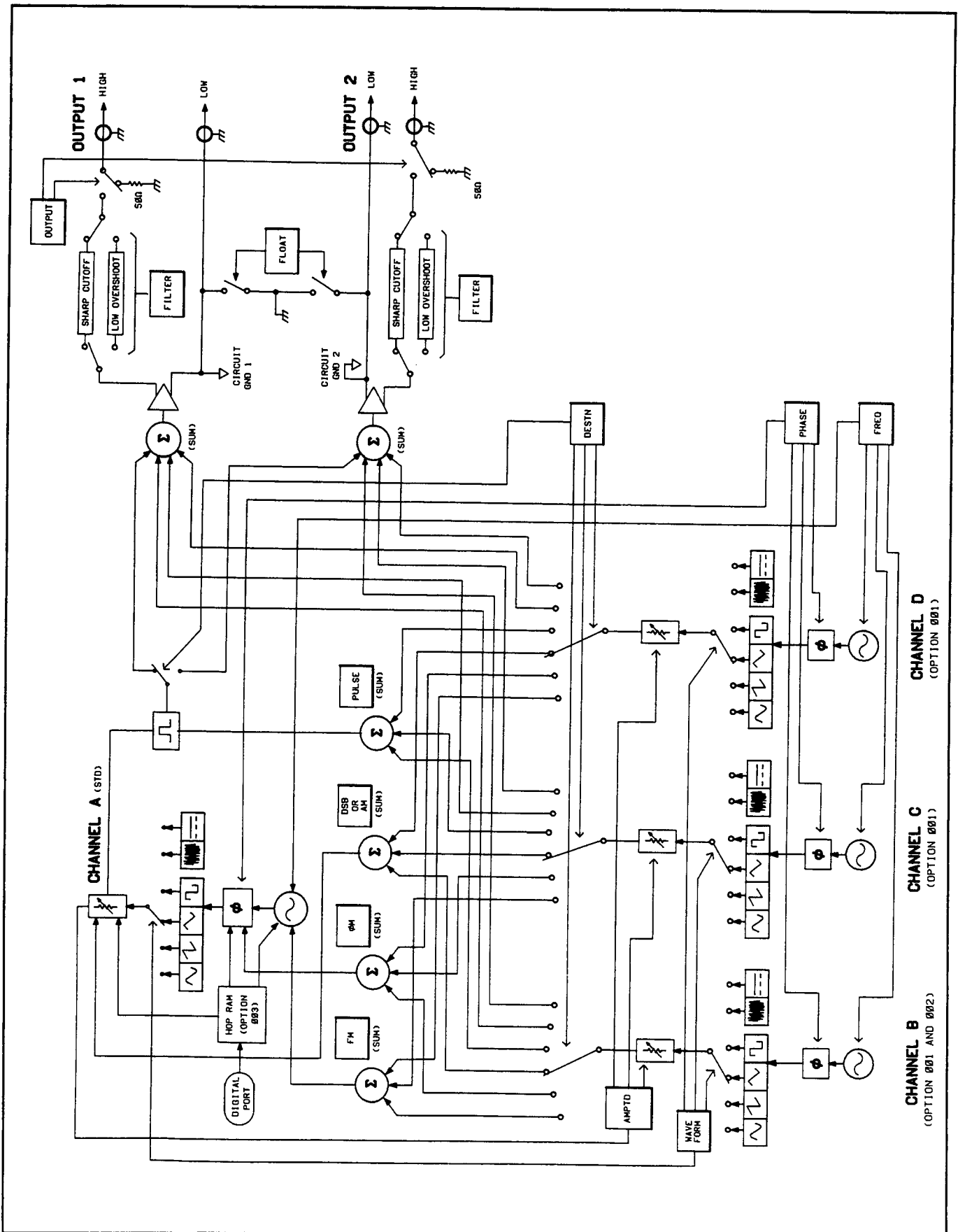

Figure 3-2. HP 8904A Signal Control Functions

3-4. INSTRUMENT FUNCTIONS AND OPERATING CONSIDERATIONS

The following paragraphs briefly explain how a signal is generated, the features included with different instrument configurations and options, and an overview of special operating considerations for each case. Abbreviated specifications are also included for quick reference. (A detailed list of all specifications is provided in Section 1.)

Detailed operating examples are given in the HP 8904A Multifunction Synthesizer *Basic Operation and Application* guide.

Standard Instrument: Creating a Simple Signal From Digital Data

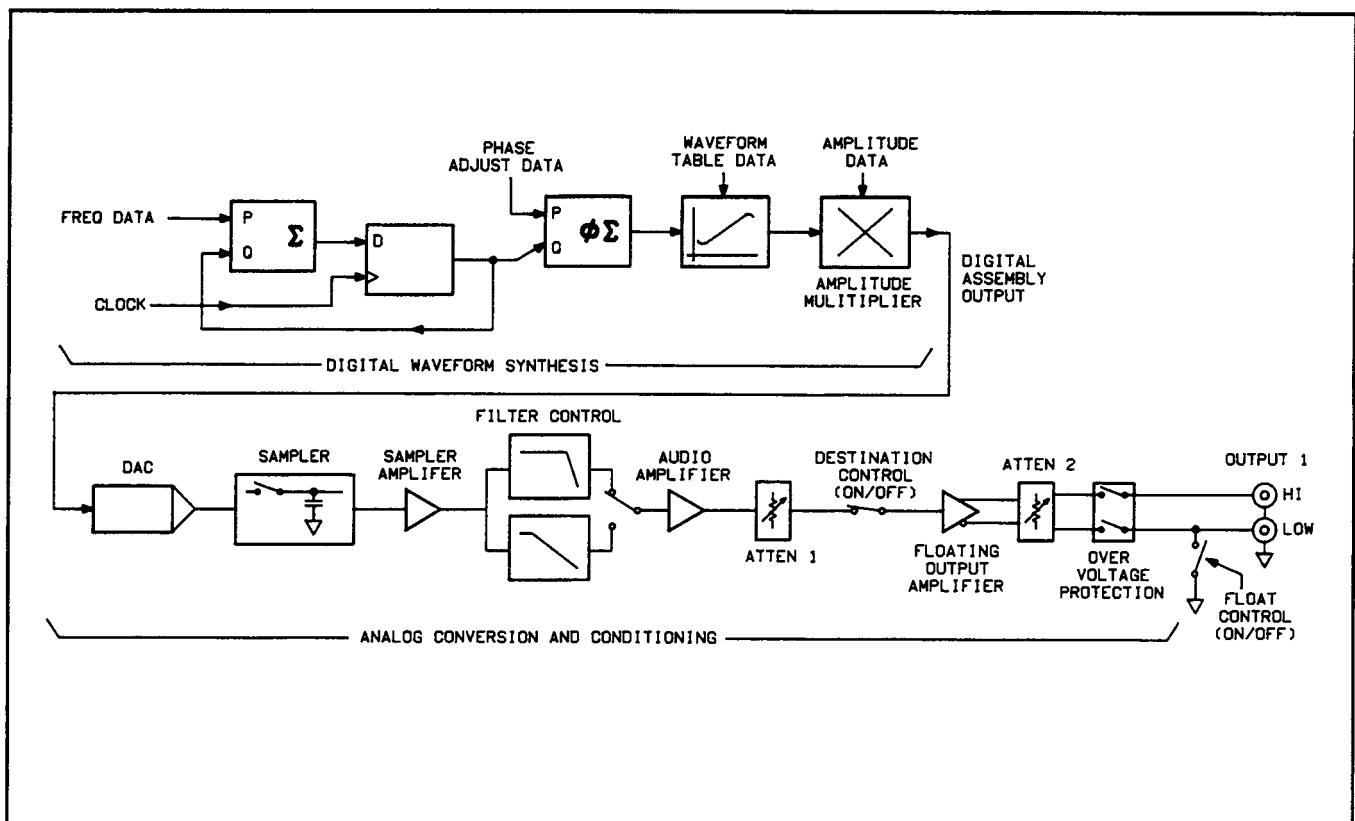

Figure 3-3. Creating A Simple Signal

How the HP 8904A Generates a Signal

Waveforms are generated by a numerical synthesis technique. The heart of the synthesizer is a single digital waveform synthesis integrated circuit (DWSIC). For each channel, the DWSIC generates a continuous stream of numbers which represent instantaneous levels of the waveform. These digital values are then converted to an analog signal by a digital-to-analog converter or DAC (one converter for each output port).

The analog signal is conditioned by conventional analog circuitry and routed to the output connector. The conditioning circuits include a sample-and-hold to remove DAC switching noise, filters to remove quantization noise (smooth the transitions between samples from the DAC), amplifiers to boost the maximum output, and attenuators to increase the outputs dynamic range.

For more detailed information on how the HP 8904A creates signals, refer to the HP 8904A Multifunction Synthesizer *Service Manual*.

Operating Considerations: All Instruments

Amplitude Resolution

The amplitude resolution of the HP 8904A is provided by a combination of digital and analog controls and can be specified in smaller increments than what is displayed on the front panel of the instrument.

Because of this method of adjustment, the amplitude resolution varies between output voltage levels. Refer to the *Operating Technical Reference: Amplitude Resolution* information included later in Section 3 if you need more information regarding very fine amplitude adjustments.

Floating Output

The HP 8904A is designed to allow the user to have a floating ground that is independent of the chassis ground of the instrument. This is why there is a **LOW** and **HIGH** connection for each output. You may also prefer a 'normal' chassis referenced ground for your application, using the shield of the **HIGH** connector for the ground reference.

The **FLOAT** control allows you to select the type of signal reference you require. The instrument always powers up in the 'floating ground' mode. If you have specified the correct output destination and amplitude for a signal, and there appears to be no signal present on the output, check to see that you have specified the correct ground reference for your application.

Waveform Jitter

Due to the digital conversion process used to create the different waveforms in the HP 8904A, a partial waveform can be present when using a ramp, square, or triangle waveform. This type of distortion is referred to as 'jitter'. This affect can be seen by displaying a 48 kHz square wave on an oscilloscope. The high/low transition period appears to have a second offset trace. For more information on what causes this affect, refer to the *Operating Technical Reference: Waveform Jitter* information included later in Section 3.

Abbreviated Channel A Specifications

Abbreviated specifications are listed here to provide general operating guidelines. Complete detailed specifications for all instrument options are listed in Section 1.

Table 3-1. Standard Instrument Capabilities

Wave Form	Frequency Range	Frequency Resolution	Phase Range	Phase Resolution	Amplitude Range	Amplitude Resolution ¹
~	0 Hz to 600 kHz	0.1 Hz	359.9° or 6.282 rad	0.1° or 0.001 rad	0 to 10 V (p-p) (50Ω load)	3 ^{1/2} digits
∧	0 Hz to 50 kHz	0.1 Hz	359.9° or 6.282 rad	0.1° or ² 0.001 rad	0 to 10 V (p-p) (50Ω load)	3 ^{1/2} digits
∨	0 Hz to 50 kHz	0.1 Hz	359.9° or 6.282 rad	0.1° or ² 0.001 rad	0 to 10 V (p-p) (50Ω load)	3 ^{1/2} digits
⌊	0 Hz to 50 kHz	0.1 Hz	359.9° or 6.282 rad	0.1° or ² 0.001 rad	0 to 10 V (p-p) (50Ω load)	3 ^{1/2} digits
Gaussian Noise	(N/A)	(N/A)	(N/A)	(N/A)	0 to 10 V (p-p) (50Ω load)	3 ^{1/2} digits
≡	(N/A)	(N/A)	(N/A)	(N/A)	± 10 V (open circuit)	3 ^{1/2} digits

¹ Refer to the *Operating Technical Reference* information later in Section 3 for a detailed explanation of Amplitude Resolution.
² Refer to the *Operating Technical Reference* information later in Section 3 for more information regarding Phase Resolution for ramp, triangle, and square waves.

Option 001 - Three More Channels, Summation, Modulation, and Sequencing

Operating Tutorial

- HP 8904A Multifunction Synthesizer *Operation and Application* guide (HP part 5953-8491): Contains detailed operating instructions for most of the capabilities provided by Option 001. Instruments with serial prefix 2948A and above have additional functions available with Option 001 that are documented in section 3C.

Waveform Examples

- HP 8904A Multifunction Synthesizer *Waveform Catalogue* (HP part 5953-8494): Contains examples of several types of waveforms that can be created with Option 001 and the instrument settings used to obtain those signals.

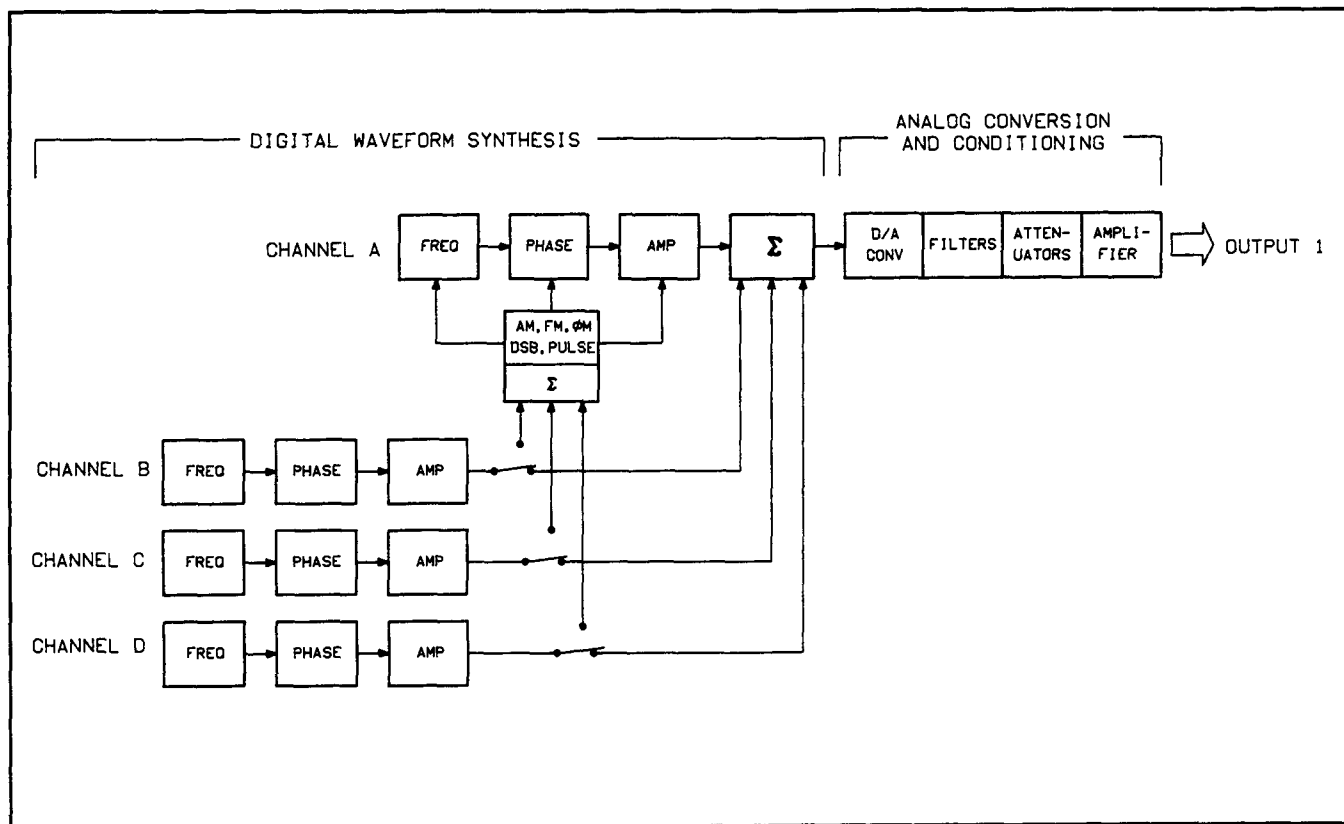

Figure 3-4. HP 8904A Option 001 Operation

Addition of Channels B, C, and D

These additional channels are generated using the same technique that provides channel A. The Frequency, Phase, Amplitude, Waveform, and Destination of each channel can be individually controlled to produce a combination of modulated and summed signals.

Summation

You can sum two, three, or four channels together into a single output. You can sum two or three channels together to produce a composite modulation signal for modulating channel A. For instance, you could use channels B and C to modulate channel A, and then sum channel D with the modulated channel A signal. (Refer to *Operating Considerations: Summation* for additional information.)

Modulation

You can use one or more of the three additional channels to modulate channel A. (Only channel A can be modulated.) Multiple channels can be summed together to provide composite modulation signals; such as those used for FM Stereo broadcasts or VOR Navigation. (Refer to *Operating Considerations: Summation* for additional information on summing modulating signals.)

External modulation is not provided.

Sequencing

Sequencing allows you to output a sequence of Tone, DTMF (Dual Tone Multi Frequency), or Digital signals. Each of the individual signals in a sequence can be defined to provide very exacting signaling capabilities. Sequencing can be set to run continuously, or one sequence at a time using manual control.

Tone Sequencing - You can specify up to 16 individual tones; creating a sequence of up to 750 tones. You can adjust the order of the tones to appear in any sequence. The Frequency, On Time, and Off Time of each tone can be individually set.

DTMF Sequencing - The DTMF signals are the same as those used for tone-type telephone communications. Sixteen different DTMF signals are available for creating a sequence of up to 750 tones. You can adjust the order of the tones to appear in any sequence. The On Time and Off time of each tone can be individually set.

Digital Sequencing - Digital sequencing allows you to specify a series of digital on/off values to be output. The Sequence Base, Period, On Level, and Off Level are adjustable. Sequences of up to 3000 bits values may be specified.

Hop RAM Sequencing - Hop RAM sequencing offers a combination of the capabilities of tone and digital sequence modes. Sixteen signal states can be preset, each with an associated amplitude, frequency, and phase value. Sequences of up to 750 tones can be output if all sixteen output states (Hexadecimal) are used. Sequences of up to 3000 tones can be output if only two output states (Binary) are used.

FM Stereo - The FM Stereo composite generator mode allows the user to test FM broadcast stereo receivers. All of the associated FM stereo signal parameters are adjustable for maximum flexibility.

Operating Considerations: Option 001

Summation

Summation may be done using many combinations of signal output and modulation schemes. All combinations of channel summation are acceptable, EXCEPT FOR: [A+C and B+D] or [A+D and B+C] at the same time. (You may not sum two sets of non-adjacent channels.) However, you can sum and output two adjacent channels, such as B+C, and *modulate* channel A with the non-adjacent channel D.

Abbreviated Specifications: Option 001

Abbreviated specifications are listed here to provide general operating guidelines. Complete detailed specifications for options 001 to 003 are listed in Section 1. Specifications for Option 005 and above are provided in supplements at the end of this section.

Modulation

Modulation of channel A only; using a sinewave carrier and modulating signal.

Table 3-2. Option 001: Modulation Capabilities

Modulation	Rate	Range	Resolution
AM	0 Hz to 600 kHz	1% to 100% of carrier amplitude	0.1% of carrier amplitude
FM	0 Hz to 600 kHz	0 Hz to 600 kHz ¹	0.1 Hz or 3½ digits, whichever is less
ΦM	0 Hz to 600 kHz	0° up to 179.9° ² per channel	0.1° or 0.001 radians
Pulse	0 Hz to 50 kHz	(N/A)	(N/A)
DSBSC	0 Hz to 600 kHz	0 V TO 10 V	3½ digits ³
¹ FM deviation range: $F_{\text{carrier}} + F_{\text{deviation}} \leq 600 \text{ kHz}$ ² ΦM range: $F_{\text{carrier}} + \left(\frac{F_{\text{mod}} \times DEV^\circ}{57.3} \right) \leq 600 \text{ kHz}$ ³ Refer to the <i>Operating Technical Reference</i> information later in Section 3 for a detailed explanation of Amplitude Resolution.			

Summation

Channel-to-channel phase accuracy (equal amplitude, sinewave signals summed into one output): ±0.1° or 30 ns, 0.1 Hz to 100 kHz, whichever is greater.

Maximum output level for signals being summed is 10V into an open circuit.

(Refer to the *Operating Considerations: Summation* information immediately preceding the *Abbreviated Specifications* for additional information.)

Sequencing

Table 3-3. Option 001: Sequencing Capabilities

Sequence Type	Signal Format	Number of Different Signals	Maximum Sequence Length
Tone	Single Frequency Tones	16 different user-defined frequencies	250 tones
DTMF	Dual Tone Multi Frequency	16 standard DTMF tone pairs (0-9,A-D,#,*)	250 tones
Digital	Binary, Octal or Hexadecimal codes: Output Serially	16 (0-F Hex)	250 4-bit words (1000 bits)
Hop RAM	Single Freq. Tones Hexadecimal, Octal, or Binary Codes	16 (0-F Hex)	750 4-bit words (3000 bits)

Option 002 - A Second Channel and Output

NOTE

The following description pertains to instruments with Option 002 only. Addition of Option 001 provides more flexibility for using the second channel and output.)

Channel B and Output 2 Are Added

The second channel and output added by Option 002 are identical in function and operation to the standard single channel and output included with all instruments.

The Frequency, Amplitude, Phase, and Waveform of channel B are controlled separately from channel A, allowing you to output two completely different signals at once. The Outputs for the two channels are also independently controlled. The phase relationship between the two channels is precisely controlled and can be altered by adjusting the Phase of either channel.

Operating Considerations: Option 002

Destination Control

Option 002 does not allow you to change the Destination of the two channels. Channel A is always designated for Output 1; Channel B is always designated for Output 2. (See note above.)

Abbreviated Specifications: Option 002

The specifications for channel B are identical to those of channel A listed in Section 1.

Output 1 to Output 2 phase accuracy (sine waves at the same frequency):

$\pm 0.1^\circ$ or 30 ns, 0.1 Hz to 100 kHz, whichever is greater.

Option 003 - Frequency, Amplitude, and Phase Hopping

Operating Tutorial

- HP 8904A Multifunction Synthesizer *Operation and Application* guide (HP part 5953-8491): Contains detailed operating instructions for accessing the HOP Ram menu and specifying all of the parameters to be hopped.

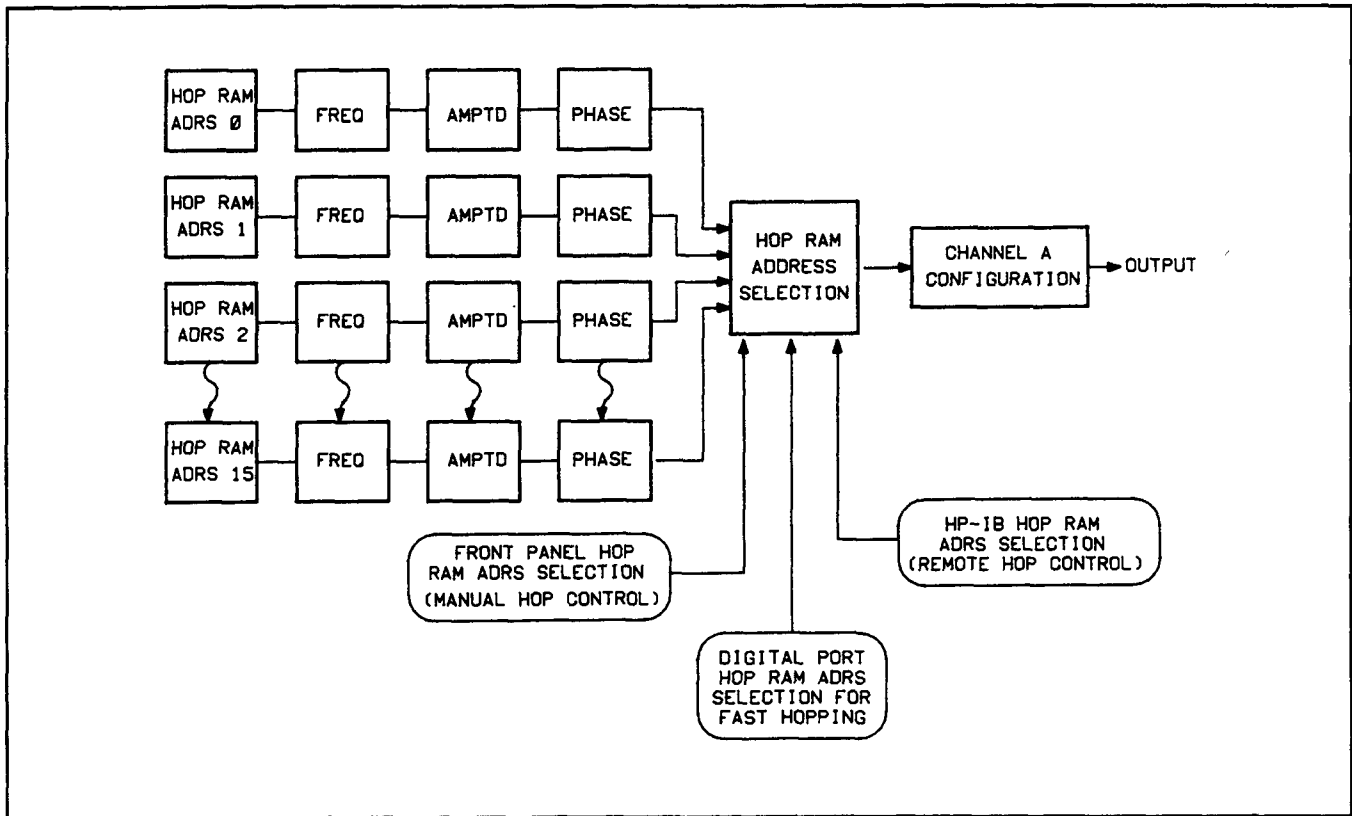

Figure 3-5. HP 8904A Option 003: Hopping Between 16 Channel A Settings

How Hopping is Performed

Option 003 allows you to define 16 different channel A frequency, phase, and amplitude configurations, and store them in the Hop Ram section of memory. You can then tell the HP 8904A which configuration you want to output by selecting the appropriate Hop Ram Address using any of three methods:

- Direct front panel selection
- Remote selection using the HP-IB connector
- Setting a binary address on the Digital Port Hop Register connections

A detailed example of using direct front panel controls to perform hopping is provided in the HP 8904A Multifunction Synthesizer *Operation and Application* guide. This tutorial also has programming examples and HP-IB code lists to allow you to perform hopping by remote control.

The use of the Digital Port to perform hopping is discussed later in Section 3 in the *Digital Port* information.

Operating Considerations: Option 003

- Only channel A's parameters can be hopped.
- If your HP 8904A is equipped with four channels (Option 001), channel A can be hopped while it is being modulated or summed with other signals except that the amplitude setting cannot be hopped when AM or DSB modulation is selected; and the phase setting cannot be hopped when ϕM is selected.
- Hop Mode can not be used in conjunction with any of the three Signal Sequence Modes provided by Option 001.

Abbreviated Specifications: Option 003

Supplemental Characteristics

Switching Speed:

Via digital port: Typically $< 8\mu s$, $< 20\mu s$ for full filter settling.

Via HP-IB: Typically < 8 ms.

Maximum switching rate (via digital control port):

Approximately 400 kHz.

Maximum allowable address skew (via digital port):

25 ns for valid results.

3-5. DIGITAL PORT

General Information

The Digital Port on the back of your HP 8904A allows external and internal signals to be used for various signaling needs. If your instrument is equipped with Option 003, this port allows you to select Hop Ram addresses to fast hop frequency, phase, and amplitude settings.

(For more information on hopping, refer to the previous information in this section on Option 003.)

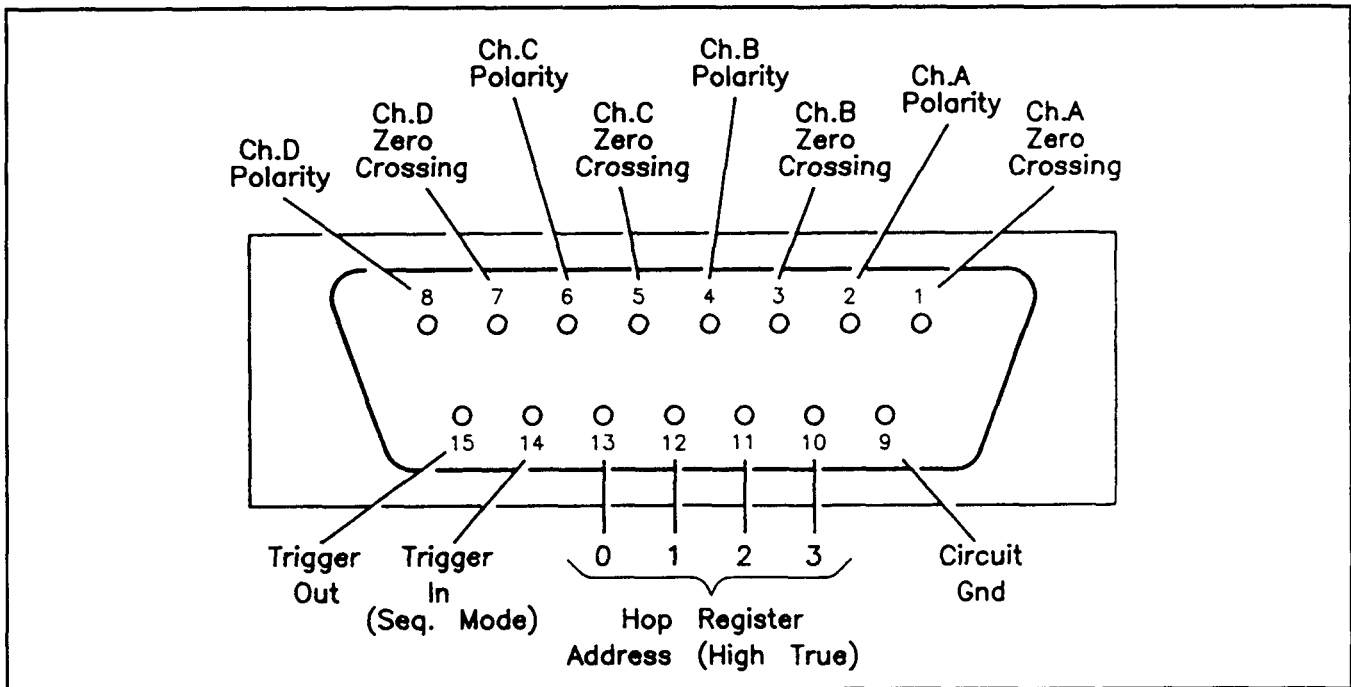

Figure 3-6. Digital Port Connections

Connector Functions

Zero Crossing Outputs

These are TTL signals that identify when the associated channel's waveform is crossing the 0 volts point in its waveform (0° and 180°). This output pulses high for approximately 600 ns each time the zero crossing occurs.

These outputs are available with all instrument configurations; regardless of what options are present in your instrument.

NOTE

Changing the Phase setting of the signal to be output alters the phase relationship between the signal and its corresponding zero crossing signal. Zero crossings are only exactly aligned with the signal being output when the Phase is set to 0° .

These outputs are only valid in the Channel Configuration mode.

Polarity Outputs

These TTL signals identify the polarity of the associated channel's waveform. The output is high for phases of 0° to 180°, and low for 180° to 360°.

These outputs are available with all instrument configurations; regardless of what options are present in your instrument.

NOTE

Changing the Phase setting of the signal to be output alters the phase relationship between the signal and its corresponding polarity signal. Polarity signal transitions are only exactly aligned with the signal being output when the Phase is set to 0°.

These outputs are used in the Channel Configuration mode only.

Circuit Gnd

This is the same as chassis ground.

Hop Register Address

These four connections are used to specify Hop Ram address for fast hopping channel A's frequency, phase, and amplitude (Option 003 only).

Once you have accessed the Hop Menu and set the desired Hop Ram parameters for each address, you can output the signal for each address by turning the Digital Port ON, and then setting the appropriate address on these connections. As each Hop Ram address is set on these pins, the corresponding channel A configuration is output.

There is a delay between the time the address is set on the Digital Port and the time the signal appears at the instrument's output. This delay is typically $8 \mu\text{s}$. The maximum rate that new addresses can be changed is about 400 kHz (every 2.5 μs).

A schematic showing an example of a circuit used to fast hop is provided in the *Option 003* section of the HP 8904A Multifunction Synthesizer *Operation and Application* guide.

The timing diagram below illustrates fast hopping the signal at the maximum rate of 400 kHz (changing the address on the Hop Register Address pins every 2.5 μs).

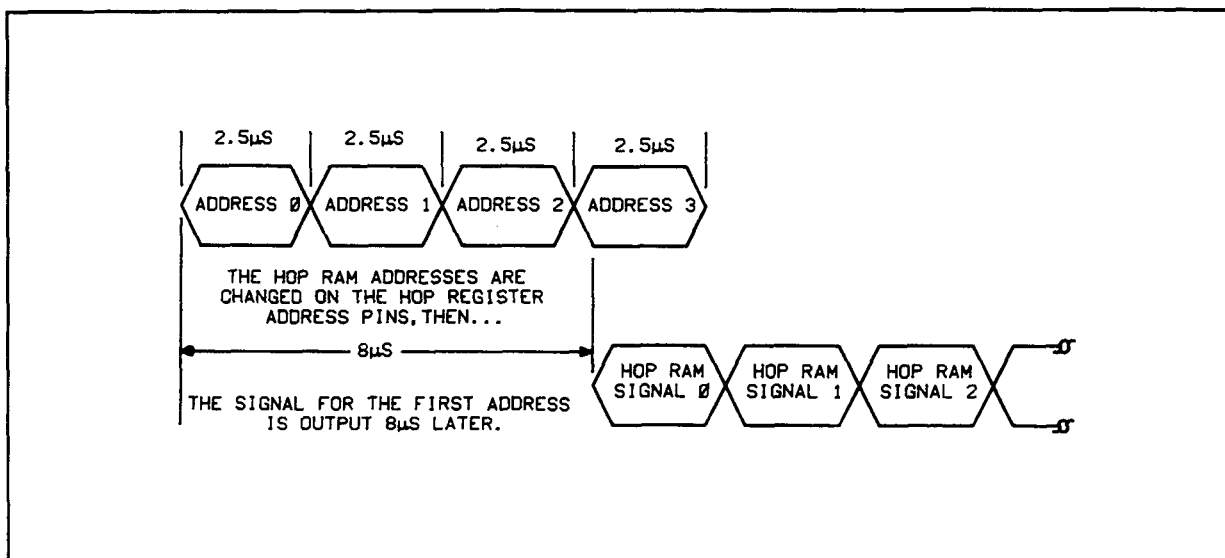

Figure 3-7. Fast Hop Timing Diagram

Trigger In

This signal is used to initiate a single DTMF, Tone, or Digital sequence for instruments equipped with Option 001. It duplicates the **f1 Single** function to start a sequence.

You can demonstrate this function by setting up a sequence and then connecting pins 9 and 14 together to trigger the sequence. The sequence is re-triggered each time a high-to-low transition is applied to this pin.

Trigger Out

This pin is not used with any of the current options and does not provide a useable output at this time.

3-6. REMOTE OPERATION

General Information

The Hewlett-Packard Interface Bus (HP-IB) is an IEEE-488 compatible digital remote control system used for controlling up to 15 different instruments at one time. It uses common TTL level signals for 8 data lines and 8 interface and communication management lines. A description of the HP-IB connector is provided at the end of Section 2 of this manual.

The HP 8904A Multifunction Synthesizer can be remotely controlled via the HP-IB to perform any function that can be done with the front panel keys; with the exception of turning line power on or off and reading or setting the HP-IB address.

The HP-IB address is read and changed by using the **ADRS** key. Valid addresses are 00 to 30.

Tutorial

- *Tutorial Description of the Hewlett-Packard Interface Bus* (HP part number 5952-0156) This very helpful guide explains the capabilities and specifications for understanding and using HP-IB control. Hardware setup, interface circuitry, and programming are discussed in detail. It is written to both the experienced and inexperienced user.

Programming Considerations

- HP-IB programs examples in this manual are written in HP BASIC language.
- This manual is not intended to teach BASIC language programming. The tables and programming examples that follow assume that you have enough programming experience to understand and apply the information given in them.
- Some parameters must be specified before others; such as specifying the correct destination for a signal before setting its amplitude, and entering the proper mode for the type of signal you need before attempting to set any signal parameters in that mode.
- The front panel display only changes to show what mode the instrument is in when changing parameters remotely. The different parameters that can be changed are not shown as they are being altered. To be able to view the parameter changes during HP-IB operation, you must manually select the menu that shows the parameters you want to look at before sending the HP-IB commands.

HP-IB Compatibility

The following codes denote the various remote control abilities built into the HP 8904A. Codes with the 'not bar' over them indicate abilities that are not available in this instrument. (Refer to the Glossary in the HP-IB tutorial for more information on the meaning of these codes.)

SH1 - Source Handshake: full capability.

AH1 - Acceptor Handshake: full capability.

T6 - Talker: Basic Talker, Serial Poll, Talk Only Mode, Unaddress if MLA.

TE0 - Extended Talker: Basic Talker, Serial Poll, Talk Only Mode, Unaddress if MLA.

L4 - Listener: Basic Listener, Listen Only Mode, Unaddressed if MTA.

LE0 - Extended Listener: Basic Listener, Listen Only Mode, Unaddressed if MTA.

SR1 - Service Request: full capability.

RL1 - Remote Local: complete capability.

PP1 - Parallel Poll: remote configuration.

DC1 - Device Clear: full capability.

DT0 - Device Trigger: no capability.

C0 - Controller: no capability.

HP-IB Code Listings for the HP 8904A

The following pages contain listings of the HP-IB programming codes for the HP 8904A. The codes are arranged in four tables. The first table (Table 3-5) contains the HP-IB codes for the functions that are standard to all HP 8904A configurations. Tables 3-5 through 3-7 contain the commands that are unique to each of the Configuration Options (001, 002 and 003). A sample program is presented after each table to demonstrate the use of the codes.

Note: *The HP-IB code listings and programming examples for options after Option 003 are provided in the individual option supplements at the end of this chapter.*

Table 3-4. HP-IB Codes for the Standard HP 8904A Functions (1 of 5)

Function	HP-IB Code	Description
Amplitude	AP	Form: AP<Channel><Amplitude Value><Terminator> Example: "APA1VL" Set amplitude of a channel. Valid terminators for amplitude are VL, MV and UV.
Backlight	BO BF	Backlight On Backlight Off
Beep	BP	Beep
Exit	EM	Form: EM Exit Mode. Exit Mode needs no data.(Returns instrument to Main Selection Level) .
Filter	FS SH LO AU	Form: FS<Output Number><Filter> Example: "FS1AU" Output Board Filter Select. Designate Output Port 1 (or 2 if the instrument is equipped with Option 02) followed by (no space) the desired filter. Elliptic (Sharp Cutoff) Gaussian (Low Overshoot) Auto (Automatic)
Float Control	FC	Form: FC<Output Number><ON or OF> Example: "FC1ON" Float Output On/Off Control. Designate Output Port 1 (or 2 if the instrument is equipped with Option 02) followed by (no space) the desired state.
Frequency	FR	Form: FR<Channel><Frequency Value><Terminator> Example: "FRA20KZ" Set frequency of channel. Valid terminators for frequency are HZ and KZ.

Table 3-4. HP-IB Codes for the Standard HP 8904A Functions (2 of 5)

Function	HP-IB Code	Description
Go To Mode	GM	<p>Form: GM <Mode Number> Example: "GM4"</p> <p>Go to Mode. Go to Mode accepts the values 0-9.</p> <p>0 = Channel Configuration Mode. 1 = (Reserved for future options.) 2 = Tone Sequence Mode. 3 = DTMF Sequence Mode. 4 = Digital Sequence Mode. 5-9 = (Reserved for future options.)</p>
Help	HP	This function will return a three digit ASCII string representing the Error Number (000 to 255 where 0 means no error reported). Refer to Appendix B for the list of Help Messages.
ID	ID	<p>Read the ID message. A read of the ID string sends 80 characters to the requesting controller in the following format:</p> <p>"HP8904A Opts 01/02/03" "Firmware Revision XXXXXa Serial No XXXXX"</p>
Increment Set	IS UP DN	<p>Form: <Parameter>IS<Value> Example: "APAIS1VL"</p> <p>Increment set. Used for any parameter that can be modified by the Up and Down commands.</p> <p>UP Increment DN Down</p> <p>Examples: "PHAUP", "UPDNDN", "DN"</p> <p>UP and DN can be used for settings which have an associated increment set value. They can be prefixed by a specific function, or used by themselves to modify the presently active function.</p>
Last	<	Use like the LAST key to access the previous display.
Next	>	Use like the NEXT key to access the next display.
Off	OF	Off
On	ON	On
Output Control	OO	<p>Form: OO<Output Number><ON or OF> Example: "OO1OF"</p> <p>Output On/Off Control. Designate Output Port 1 (or 2 if the instrument is equipped with Option 02) followed by (no space) the desired state.</p>

Table 3-4. HP-IB Codes for the Standard HP 8904A Functions (3 of 5)

Function	HP-IB Code	Description																																																																																				
Phase	PH	Form: PH<Channel><Phase Value><Terminator> Example: "PHA45DG" Set phase of a channel. Valid terminators are DG and RD.																																																																																				
Phase Reset	PR	Phase reset establishes a common zero phase reference for the channels.																																																																																				
Preset	PS	Instrument Preset																																																																																				
Query Data	?	<p>Example: Output 726;"FRA?" Enter 726;Freq_a_value\$</p> <table border="1"> <thead> <tr> <th>Query Form</th> <th>ASCII Data</th> <th>Implied Units</th> <th>Destination</th> </tr> </thead> <tbody> <tr> <td>FRx?</td> <td>0000000.0</td> <td>Hz</td> <td>N/A</td> </tr> <tr> <td>APx?</td> <td>00.000000</td> <td>Volts</td> <td>Out1-4, Dsb</td> </tr> <tr> <td>APx?</td> <td>+00.000000</td> <td>Volts</td> <td>Out1-4, (DC)</td> </tr> <tr> <td>APx?</td> <td>-00.000000</td> <td>Volts</td> <td>Out1-4, (DC)</td> </tr> <tr> <td>APx?</td> <td>0000000.0</td> <td>Percent</td> <td>Am</td> </tr> <tr> <td>APx?</td> <td>0000000.0</td> <td>Hz</td> <td>Fm</td> </tr> <tr> <td>APx?</td> <td>0000000.0</td> <td>Degrees</td> <td>Phase Mod</td> </tr> <tr> <td>APx?</td> <td>00000000</td> <td></td> <td>Pulse Mod</td> </tr> <tr> <td>PHx?</td> <td>0000.0</td> <td>Degrees</td> <td>N/A</td> </tr> <tr> <td>Wfx?</td> <td>00000</td> <td>See Return Value</td> <td>N/A</td> </tr> <tr> <td>DEx?</td> <td>00000</td> <td>See Return Value</td> <td></td> </tr> </tbody> </table> <p>Where "x" is the channel number A-D.</p> <table border="1"> <thead> <tr> <th>Return Value</th> <th>Waveform</th> <th>Return Value</th> <th>Destination</th> </tr> </thead> <tbody> <tr> <td>00001</td> <td>Sine</td> <td>00007</td> <td>Am</td> </tr> <tr> <td>00002</td> <td>Ramp</td> <td>00008</td> <td>Fm</td> </tr> <tr> <td>00003</td> <td>Triangle</td> <td>00009</td> <td>Phase Mod</td> </tr> <tr> <td>00004</td> <td>Dc</td> <td>00010</td> <td>Dsb</td> </tr> <tr> <td>00005</td> <td>Noise</td> <td>00011</td> <td>Pulse Mod</td> </tr> <tr> <td>00006</td> <td>Square</td> <td>00012</td> <td>Out1</td> </tr> <tr> <td></td> <td></td> <td>00013</td> <td>Out2</td> </tr> <tr> <td></td> <td></td> <td>00016</td> <td>Off</td> </tr> </tbody> </table>	Query Form	ASCII Data	Implied Units	Destination	FRx?	0000000.0	Hz	N/A	APx?	00.000000	Volts	Out1-4, Dsb	APx?	+00.000000	Volts	Out1-4, (DC)	APx?	-00.000000	Volts	Out1-4, (DC)	APx?	0000000.0	Percent	Am	APx?	0000000.0	Hz	Fm	APx?	0000000.0	Degrees	Phase Mod	APx?	00000000		Pulse Mod	PHx?	0000.0	Degrees	N/A	Wfx?	00000	See Return Value	N/A	DEx?	00000	See Return Value		Return Value	Waveform	Return Value	Destination	00001	Sine	00007	Am	00002	Ramp	00008	Fm	00003	Triangle	00009	Phase Mod	00004	Dc	00010	Dsb	00005	Noise	00011	Pulse Mod	00006	Square	00012	Out1			00013	Out2			00016	Off
Query Form	ASCII Data	Implied Units	Destination																																																																																			
FRx?	0000000.0	Hz	N/A																																																																																			
APx?	00.000000	Volts	Out1-4, Dsb																																																																																			
APx?	+00.000000	Volts	Out1-4, (DC)																																																																																			
APx?	-00.000000	Volts	Out1-4, (DC)																																																																																			
APx?	0000000.0	Percent	Am																																																																																			
APx?	0000000.0	Hz	Fm																																																																																			
APx?	0000000.0	Degrees	Phase Mod																																																																																			
APx?	00000000		Pulse Mod																																																																																			
PHx?	0000.0	Degrees	N/A																																																																																			
Wfx?	00000	See Return Value	N/A																																																																																			
DEx?	00000	See Return Value																																																																																				
Return Value	Waveform	Return Value	Destination																																																																																			
00001	Sine	00007	Am																																																																																			
00002	Ramp	00008	Fm																																																																																			
00003	Triangle	00009	Phase Mod																																																																																			
00004	Dc	00010	Dsb																																																																																			
00005	Noise	00011	Pulse Mod																																																																																			
00006	Square	00012	Out1																																																																																			
		00013	Out2																																																																																			
		00016	Off																																																																																			

Table 3-4. HP-IB Codes for the Standard HP 8904A Functions (4 of 5)

Function	HP-IB Code	Description																											
Recall	RC	<p>Form: RC<Register> Example: "RC11" Recall. Valid data values for Recall are 0-11.</p>																											
Reverse Power	RP	Reset reverse power protection.																											
Save	SV	<p>Form: SV<Register> Example: "SV1" Save. Valid data values for Save are 0-11.</p>																											
Service Request	RM	<p>Form: RM Read Service Request Mask. The present value of the SRQ mask in ASCII is returned, 000-191.</p>																											
	SM	<p>Form: SM<Data Value> Examples: "SM128", "SM0" Set Service Request Mask. Valid data = 0-255</p>																											
Special Functions	SF	<p>Form: SF<Data Value> Examples: "SF4", "SF17" Set or Reset Special Functions. The value of the Special Function flag can be read at any time but can only be set at the Main Selection Level. The flag is a composite of bit flags. A Special Function operation configures all 16 bits of the flag (that is, any previously set flags are lost). Do not leave a space between the mnemonic and the data value. Example: To activate Special Functions 1 and 2, the command would be: "SF6" Special1 value = 2 Special2 value = $\frac{4}{6}$</p>																											
	RSF	<p>Form: RSF Read Special Function Value. The returned value is the decimal representation of a 16 bit binary number indicating the Special Function(s) that are active. Value range 00000 to 65535 in ASCII is returned. Special Flag Bit Assignments:</p> <table border="0"> <thead> <tr> <th data-bbox="522 1487 614 1542">Special Function</th> <th data-bbox="832 1515 943 1542">Operation</th> <th data-bbox="1252 1515 1372 1542">Bit Pattern</th> <th data-bbox="1372 1549 1483 1604">Bit Weight 16 8421</th> </tr> </thead> <tbody> <tr> <td data-bbox="560 1615 574 1642">0</td> <td data-bbox="669 1615 1030 1642">Last State Recalled On Power Up</td> <td data-bbox="1129 1615 1339 1642">XXXX XXXX XXX X</td> <td data-bbox="1372 1615 1488 1642">XXX1</td> </tr> <tr> <td data-bbox="560 1649 574 1676">1</td> <td data-bbox="669 1649 1009 1676">Disable Automatic Phase Reset</td> <td data-bbox="1129 1649 1339 1676">XXXX XXXX XXX X</td> <td data-bbox="1372 1649 1488 1676">XX1X</td> </tr> <tr> <td data-bbox="560 1683 574 1710">2</td> <td data-bbox="669 1683 832 1710">Disable Beeper</td> <td data-bbox="1129 1683 1339 1710">XXXX XXXX XXX X</td> <td data-bbox="1372 1683 1488 1710">X1XX</td> </tr> <tr> <td data-bbox="560 1717 574 1744">3</td> <td data-bbox="669 1717 1009 1744">Reverse Modulating Waveforms</td> <td data-bbox="1129 1717 1339 1744">XXXX XXXX XXX X</td> <td data-bbox="1372 1717 1488 1744">1XXX</td> </tr> <tr> <td data-bbox="560 1751 574 1779">4</td> <td data-bbox="669 1751 926 1779">Disable Output Blanking</td> <td data-bbox="1129 1751 1339 1779">XXXX XXXX XXX 1</td> <td data-bbox="1372 1751 1488 1779">XXXX</td> </tr> <tr> <td data-bbox="560 1785 574 1813">5</td> <td data-bbox="669 1785 997 1813">Floating Outputs On Power UP</td> <td data-bbox="1129 1785 1339 1813">XXXX XXXX XXX 1</td> <td data-bbox="1372 1785 1488 1813">XXXX</td> </tr> </tbody> </table> <p>(...additional specials not yet implemented.....)</p> <p>Example: If Specials 0 and 4 are active, RSF will return a value of 17. Special 0 is a bit weight of 1 and Special 4 is 16 giving the result of 17.</p>	Special Function	Operation	Bit Pattern	Bit Weight 16 8421	0	Last State Recalled On Power Up	XXXX XXXX XXX X	XXX1	1	Disable Automatic Phase Reset	XXXX XXXX XXX X	XX1X	2	Disable Beeper	XXXX XXXX XXX X	X1XX	3	Reverse Modulating Waveforms	XXXX XXXX XXX X	1XXX	4	Disable Output Blanking	XXXX XXXX XXX 1	XXXX	5	Floating Outputs On Power UP	XXXX XXXX XXX 1
Special Function	Operation	Bit Pattern	Bit Weight 16 8421																										
0	Last State Recalled On Power Up	XXXX XXXX XXX X	XXX1																										
1	Disable Automatic Phase Reset	XXXX XXXX XXX X	XX1X																										
2	Disable Beeper	XXXX XXXX XXX X	X1XX																										
3	Reverse Modulating Waveforms	XXXX XXXX XXX X	1XXX																										
4	Disable Output Blanking	XXXX XXXX XXX 1	XXXX																										
5	Floating Outputs On Power UP	XXXX XXXX XXX 1	XXXX																										

Table 3-4. HP-IB Codes for the Standard HP 8904A Functions (5 of 5)

Function	HP-IB Code	Description
Terminators	KZ HZ DG RD VL MV UV ET SC MS % PC	KiloHertz Hertz Degrees Radians Volts Millivolts Microvolts Enter Seconds Milliseconds Percent Percent
Time Base	EO	Example: "EO" Read External Reference Status. This function allows you to determine whether the Time Base reference is external or internal. If the External reference is on, a 001 is returned, if not a 000 is returned.
Waveform	WF	Form: WF<Channel><Waveform> Example: "WFATR" Set waveform of a channel. Valid data values for waveform are: SI = Sine RA = Ramp TR = Triangle SQ = Square NS = Noise DC = dc.

```

10      ! *****
20      ! * HP SERIES 200/300 BASIC language *
30      ! * programming example for the      *
40      ! * standard HP 8904A MULTIFUNCTION *
50      ! * SYNTHESIZER.                    *
60      ! *****
70      !
73      OUTPUT 726;"PS"                      ! Preset HP 8904A.
80      OUTPUT 726;"GM0"                     ! Goto channel configuration mode.
90      OUTPUT 726;"FC1OF"                   ! Turn output 1 float off.
100     OUTPUT 726;"FRA1000.1HZ"             ! Set channel A frequency to 1000.1 Hz.
110     OUTPUT 726;"APA1.25VL"               ! Set channel A amplitude to 1.25 V.
120     OUTPUT 726;"PHA90DG"                 ! Set channel A phase to 90 degrees.
130     OUTPUT 726;"WFARA"                   ! Set channel A waveform to ramp.
140     END
    
```

Figure 3-8. Sample Program for Configuring Channel A

Table 3-5. HP-IB Codes That Can Be Used With Option 001 Instruments (1 of 2)¹

Function	HP-IB Code	Description
Destination	DE	<p>- Four Channel Operation -</p> <p>Form: DE<Channel><Destination></p> <p>Examples: "DEAOC1", "DEAAM"</p> <p>Set destination of channel. Valid data values for destination are AM, FM, PM, DS, PU, OC1 (OC2 if the instrument is equipped with Option 02) and OF.</p>
Modulation	AM FM PM DS PU	<p>Amplitude Modulation, valid AM terminators are % or PC.</p> <p>Frequency Modulation, valid fm terminators are KZ or HZ.</p> <p>Phase Modulation, valid PM terminators are DG or RD.</p> <p>DSB Modulation, valid DSB terminators are VL, MV, and UV.</p> <p>Pulse Modulation</p>
Amplitude	APH	<p>- Signal Sequence Modes -</p> <p>Form: APH<Amplitude Value><Terminator></p> <p>Example: "APH1.999VL"</p> <p>Enter Tone or DTMF amplitude. Amplitude terminators are VL, MV and UV.</p>
Digital Level	DAPH DAPL	<p>Digital Sequence On Level</p> <p>Digital Sequence Off Level</p> <p>Form: DAPH<Amplitude><Terminator></p> <p>Examples: "DAPH4VL", "DAPL-1VL"</p> <p>Digital Sequence Mode amplitude terminators are VL, MV and UV.</p>
Digital Sequence Base	BSB BSO BSH	<p>Select Binary Base</p> <p>Select Octal Base</p> <p>Select Hexadecimal Base</p>
Off Time	STOF	<p>Form: STOF<Time Value><Terminator></p> <p>Example: "STOF.5SC"</p> <p>Set Off Time (Tone and DTMF Sequence). Valid terminators are MS and SC.</p>
On Time	STON	<p>Form: STON<Time Value><Terminator></p> <p>Example: "STON9.3MS"</p> <p>Set On Time (Tone and DTMF Sequence). Valid terminators are MS and SC.</p>
Period	SBP	<p>Form: SBP<Time Value><Terminator></p> <p>Example: "SBP9.3MS"</p> <p>Set Period (Digital Sequence Only). Valid terminators are MS and SC.</p>
<p>¹ Option 001 capabilities have been expanded in instruments with serial prefix 2948A and above. Refer to section 3 for information concerning the Hop RAM sequence and FM Stereo functions.</p>		

Table 3-5. HP-IB Codes That Can Be Used With Option 001 Instruments (2 of 2)

Function	HP-IB Code	Description
Register Number	HRA	Form: HRA<1 or 2 Digit Address>ET Examples: "HRA2ET" "HRA15ET" Enter Tone or DTMF register. Addresses 0-15 are valid, Valid terminator is "ET".
Run Mode	RUNC RUNM RUNS STOP	Run Continuously Run Manually Run Single Stop Run
Sequence End	SEQE	Form: SEQE<Sequence End Value>ET Example: "SEQE115ET" Set Sequence End. Valid terminator is ET.
Sequence Index	SEQP	Form: SEQP<Index Value>ET Example: "SEQP37ET" Set Sequence Index. Valid terminator is ET.
Sequence String	WSQ	Form: WSQ<Data String><Terminator> Examples: Tone Sequence = "WSQ01123456789ABCDEF;" DTMF Sequence = "WSQ0123456789ABCD*#;" Digital Sequence Binary Base = "WSQ0101010101010101;" Digital Sequence Octal Base = "WSQ0123456701234567;" Digital Sequence Hex Base = "WSQ0123456789ABCDEF;" Write sequence string. Entry string is terminated with ;, cr/lf, EOI or the etx character. Maximum string length = 250 characters.
Tone Frequency	FRH	Form: FRH<Frequency Value><Terminator> Example: "FRH723.5HZ" Enter tone frequency (Tone Sequence Mode only). Valid terminators are HZ and KZ.

```

10      ! *****
11      ! * HP SERIES 200/300 BASIC language          *
12      ! * programming example for the              *
13      ! * HP 8904A MULTIFUNCTION SYNTHESIZER      *
14      ! * OPTION 001: fm stereo composite.         *
15      ! * (left channel only)                     *
16      ! *****
17      !
18      OUTPUT 726;"PS GM0"                          ! Preset and go to channel
19                                                    ! configuration mode.
20                                                    !
21      OUTPUT 726;"DEAOC1 FRA39KZ APA1VL PHA270DG WFASI" ! Set channel A to
22                                                    ! Destination = Output 1,
23                                                    ! Freq = 39 kHz, Amplitude =
24                                                    ! 1 volt, Phase = 270 degrees
25                                                    ! Waveform = Sine.
26                                                    !
27      OUTPUT 726;"DEBOC1 FRB37KZ APB1VL PHB90DG WFBSI" ! Set channel B to
28                                                    ! Destination = Output 1,
29                                                    ! Freq = 37 kHz, Amplitude =
30                                                    ! 1 volt, Phase = 90 degrees,
31                                                    ! Waveform = Sine.
32                                                    !
33      OUTPUT 726;"DEBOC1 FRC19KZ APC 100MV WFCSI"    ! Set channel C to
34                                                    ! Destination = Output 1,
35                                                    ! Freq = 19 kHz, Amplitude =
36                                                    ! 0.1 volt, Waveform = Sine.
37                                                    !
38      OUTPUT 726;"DEDOC1 FRD1KZ APD2VL WFDSI"       ! Set channel D to
39                                                    ! Destination = Output 1,
40                                                    ! Freq = 1 kHz, Amplitude =
41                                                    ! 2 volts, Waveform = Sine.
42      END

```

Figure 3-9. Sample Program for Configuring Channels A, B, C and D

```

10      ! *****
11      ! * HP SERIES 200/300 BASIC language          *
12      ! * programming example for the              *
13      ! * HP 8904A MULTIFUNCTION SYNTHESIZER      *
14      ! * OPTION 001: digital sequence.           *
15      ! *****
16      !
17      OUTPUT 726;"PS GM4"                          ! Preset and go to digital
18                                                    ! sequence mode.
19                                                    !
20      OUTPUT 726;"BSB SBPO.5MS DAPH5VL DAPL0.2VL"  ! Set sequence base to
21                                                    ! Binary, sequence period =
22                                                    ! 0.5 ms, on level = 5 volts,
23                                                    ! and off level = 0.2 volt.
24                                                    !
25      OUTPUT 726;"SEQP1ET WSQ000100110111; SEQE12ET" ! Set sequence pointer = 1,
26                                                    ! write sequence =
27                                                    ! "000100110111", and set
28                                                    ! sequence end = 12.
29                                                    !
30      OUTPUT 726;"RUNC"                            ! Run sequence continuously.
31      END

```

Figure 3-10. Sample Program for Configuring a Digital Sequence String

Table 3-6. HP-IB Codes That Can Be Used with Option 002 Instruments

Function	HP-IB Code	Description
Destination	DE	Form: DE<Channel><Destination> Examples: "DEAOF" "DEBOC2" Set destination. Valid data values for destination are OC1*, OC2* and OF. *Must also have Opt.001 with these two commands.

```

10      | *****
20      | * HP SERIES 200/300 BASIC language      *
30      | * programming example for the          *
40      | * HP 8904A MULTIFUNCTION SYNTHESIZER  *
50      | * OPTION 002.                          *
60      | *****
70      |
80      | OUTPUT 726;"PS"                        ! Preset HP 8904A.
90      |                                         !
100     | OUT 726;"GM0"                          ! Goto channel configuration mode.
110     |                                         !
120     | OUTPUT 726;"FRA2KZ APA2VL PHA45DG WFASQ" ! Set channel A frequency =
130     |                                         ! 2 kHz, amplitude = volts, phase =
140     |                                         ! 45 degrees, and waveform = square.
150     |                                         !
160     | OUTPUT 726;"FRB2KZ APB2VL PHB90DG WFBSQ" ! Set channel B frequency =
170     |                                         ! 2 kHz, amplitude = 2 volts, phase =
180     |                                         ! 90 degrees, and waveform = square.
190     |                                         !
200     | END
    
```

Figure 3-11. Sample Program for Configuring Output Ports 1 and 2

Table 3-7. HP-IB Codes That Can Be Used with Option 003 Instruments

Function	HP-IB Code	Description
Amplitude Hop On/Off	APH AHR	<p>Form: APH<Amplitude Value><Terminator> Example: "APH2.123VL" Enter Hop Mode amplitude parameter. Valid terminators are VL, MV and UV.</p> <p>Form: AHR<ON or OF> Example: "AHROF" Amplitude Hop On/Off Control.</p>
Digital Port	DPE	<p>Form: DPE<ON or OF> Example: "DPEOF" Digital Port On/Off Control.</p>
Frequency Hop On/Off	FRH FHR	<p>Form: FRH<Frequency Value><Terminator> Example: "FRH723.5HZ" Enter Hop Mode frequency parameter. Valid terminators are HZ and KZ.</p> <p>Form: FHR<ON or OF> Example: "FHROF" Frequency Hop On/Off Control.</p>
Hop Register	HRA	<p>Form: HRA<1 or 2 Digit Address>ET Example: "HRA9ET" Enter Hop Register address. Addresses 0-15 are valid, valid terminator is ET.</p>
Phase Hop On/Off	PHH PHR	<p>Form: PHH<Phase Value><Terminator> Example: "PHH59.3DG" Enter Hop Mode phase. Valid terminators are DG and RD.</p> <p>Form: PHR<ON or OF> Example: "PHROF" Phase Hop On/Off Control.</p>
Query Port Status	QRE	<p>Form: QRE Example: "QRE" The Port Status value is the sum of four states. Port Status = DPE value + FHR value + PHR value + AHR value.</p> <p>Bit Weight</p> <p>DPE value: On=16 Off=0 FHR value: On=8 Off=0 PHR value: On=4 Off=0 AHR value: On=2 Off=0</p>

```

10 | *****
20 | * HP SERIES 200/300 BASIC language *
30 | * programming example for the *
40 | * HP 8904A MULTIFUNCTION SYNTHESIZER *
50 | * OPTION 003: fast hop. *
60 | *****
70 |
80 | OUTPUT 726;"PS GM0" ! Preset and go to channel
90 | ! configuration mode.
100 |
110 | OUTPUT 726;"HRA0ET FRH500HZ APH1VL" ! Set Hop Ram address = 0,
120 | ! Hop Freq = 500 Hz, Hop
130 | ! Amplitude = 1 volt.
140 |
150 | OUTPUT 726;"HRA1ET APH2VL" ! Set Hop Ram address = 1,
160 | ! Hop Freq = 1 kHz, Hop
170 | ! Amplitude = 2 volts.
180 |
190 | OUTPUT 726;"HRA2ET FRH1.5KZ APH3VL" ! Set Hop Ram address = 2,
200 | ! Hop Freq = 1.5 kHz, Hop
210 | ! Amplitude = 3 volts.
220 |
230 | OUTPUT 726;"HRA3ET FRH2KZ APH4VL" ! Set Hop Ram address = 3,
240 | ! Hop Freq = 2 kHz, Hop
250 | ! Amplitude = 4 volts.
260 |
270 | OUTPUT 726;"HRA4ET FRH2.5KZ APH5VL" ! Set Hop Ram address = 4,
280 | ! Hop Freq = 2.5 kHz, Hop
290 | ! Amplitude = 5 volts.
300 |
310 | OUTPUT 726;"HRA5ET FRH3KZ APH6VL" ! Set Hop Ram address = 5,
320 | ! Hop Freq = 3 kHz, Hop
330 | ! Amplitude = 6 volts.
340 |
350 | OUTPUT 726;"FHRON AHRON" ! Turn frequency hop on,
360 | ! and turn amplitude hop on.
370 |
380 | FOR I=1 TO 100 ! Repeat hop seq 100 times.
390 |   FOR J=0 TO 5 ! Step from add=0 TO add=5.
400 |     OUT 726;"HRA",J,"ET" ! Hop to next address.
410 |   NEXT J
420 | NEXT I
430 | END

```

Figure 3-12. Sample Program for Hop Mode Operation

3-7. STATUS BYTE

General Information

The Status Byte provides information concerning instrument conditions. Seven of the 8 bits are used to indicate specific problems or instrument conditions that can occur during operation. The other bit is used to alert the controller regarding these conditions.

The operator can use the Status Byte during HP-IB control to perform a user defined operation that is dependant on the status of the instrument.

Table 3-8. HP 8904A Status Byte Definitions

Bit #	Weight	Condition	Description
7	128	(Not Used)	
6	64	RQS bit	This bit signals the controller that an interrupt has been generated by one or more of the other status bits.
5	32	Reserved for future use.	
4	16	Reverse Power Triggered.	Reverse Power Protection Circuit has been triggered.
3	8	Signalling Sequence Stopped	Indicates that a DTMF, Tone, or Digital sequence has ended. (Used with Opt 001 only).
2	4	Signalling Sequence Started	Indicates that a DTMF, Tone, or Digital sequence has started. (Used with Opt 001 only).
1	2	Timebase Out of Lock	The reference oscillator loop on the digital (A2) assembly is out of lock.
0	1	Invalid HP-IB Command	An invalid code has been received on the bus, or an error has been made in programming the instrument.

Using the Status Byte

Each of the 8 bits has an equivalent numeric weighting associated with it. This numeric value is used to indicate when a bit has been set to a 'high' condition. It is this weighting that is used to read from and write to the Service Mask.

Service Mask

The Service Mask determines what bits in the Status Byte are used to initiate a service request interrupt (SRQ). It "masks" the interrupts that you don't want to be active, and enables the interrupt(s) that you do want active. You can both read the Service Mask to view the current settings, and write to the Service Mask to change the settings for your needs.

Reading the Service Mask

To read the current Service Mask setting, simply use the HP-IB command **RM** to return the weighted value. A simple program for reading the Service Mask is as follows:

```
10      OUTPUT 726;"RM"  
20      ENTER 726;A$  
30      PRINT "SERVICE MASK VALUE=";A$  
40      END
```

Setting the Service Mask

To set the Service Mask to define the SRQ generating condition you want active, use the HP-IB command **SM** along with the weighted value. For example, if you wanted to set the Service Mask to only allow an interrupt if a reverse power condition occurs, you would output the command:

```
OUTPUT 726;"SM16"
```

Error Isolation

Any time an interrupt occurs you can press the **HELP** key on the front of the HP 8904A to display a brief description of the error, or use the HP-IB command **HP** to read the error number. A list of Error Codes is provided in this section to help you isolate any hardware, software, or operation faults that occur.

If you are writing a program that responds to an SRQ condition, you must first enable the interrupt for your controller and then perform a serial poll to return the Status Byte value. You can then use this value to interpret the condition of the HP 8904A and generate whatever response to the condition you want.

The following programming example is given to help you understand how to retrieve Status Byte information.

```

10      !
20      ! EXAMPLE PROGRAM OF STATUS BYTE USE FOR HP 8904A
30      !
40          DIM Error$(250)
50          Select_code=7
60          Hpib_address=726                ! HP-IB address of HP 8904A.
70          Mask=67                        ! User defined mask value.
80          OUTPUT Hpib_address;"SM",Mask  ! Send mask to HP 8904A, this
90          !                               mask allows SRQ, timebase out
100         !                               of lock & HPIB errors.
110        ON INTR 7 GOTO Service_request  ! When SRQ, goto service routine.
120        ENABLE INTR Select_code;2      ! * Enable computer SRQ interrupt.
130        OUTPUT Hpib_address;"APE 1 VL" ! HPIB programming error to
140        !                               ! demonstrate an SRQ response.
150        !
160 Service_request:                       ! Routine to check status byte.
170        Status_byte=SPOLL(Hpib_address) ! Get status byte.
180        SELECT Status_byte              ! Determine error type.
190        CASE =65
200            Errors$="HP-IB Programming Error"
210        CASE =66
220            Errors$="Timebase Out Of Lock"
230        CASE ELSE
240            Errors$=""
250        END SELECT
260        PRINT Error$
270        END

```

- Select_code 7 indicates HP-IB as the source. The 2 is this computer's code that tells it to allow on SRQ interrupt.

Figure 3-13. Sample Program for Using Status Byte Information

3-8. ERROR CODES AND HELP MESSAGES

When the HP 8904A detects an inappropriate operating condition (such as when an inactive key is pressed), it beeps to let you know that a message about the condition is available on the Help display.

The HP 8904A's Help display is accessed by pressing the blue **SHIFT** key and then the **HELP** key. The following table lists the Error Number for each Help Message displayed by the HP 8904A along with a brief description of the operating conditions that will cause the HP 8904A to display the message.

Table 3-9. Error Numbers and Description Listings for the HP 8904A's Help Messages (1 of 3)

Error Number	Description
0	There is no new message.
1	A key was selected without specifying what the data was related to.
2	The key selected does not correspond to the function selected.
3	Invalid HP-IB address entry. (Only 00-30 (decimal) are valid entries.)
4	The \uparrow or \downarrow key cannot be used with this function.
8	A key on the front panel is stuck. This is normally found at power-up. Refer to the HP8904A Service Manual to isolate the problem.
10	The instrument cannot access the output board that connects to the OUTPUTS 1 connector. Refer to the HP 8904A Service Manual to isolate the problem.
11	A hardware error was detected by the power-up checks. Refer to the HP 8904A Service Manual to isolate the problem.
12	The reference loop of the Digital Synthesis (A2) assembly is out of lock. Refer to the HP 8904A Service Manual to isolate the problem.
16	The Special Function display can only be accessed from the Main Selection Level.
13	A reverse power error was detected on an output board. (Disconnect the affected output from any external equipment and re-enter the key sequence that originally resulted in the error. If an error is still detected by the instrument, a reverse power problem still exists.)
14	The recalled Save Register does not contain a SAVE setting.
15	The selected function cannot be performed in the present mode. (For example, the FREQ function cannot be executed directly from the Main Selection Level.)
17	An invalid Special Function number was entered. (Only Special Functions 0 - 15 (decimal) may be entered.)
18	The Special Function number input was too large for the instrument to recognize it as data. This condition occurs when the data input is greater than 65535. (Refer to Error Message 17 concerning the range of Special Functions available.)
19	The number entered was too large for the function selected.
20	Increment Set is not available with the function selected.
22	An operation was directed to an output board which does not exist.
24	There are no set table modes or functions at this instrument level. (For example, in Hop Mode Operation the Hop Parameter display lists only four keys that will perform a function in this mode; f1, f2, f3 and f4. Any other key, such as AMPTD, has no meaning in this mode and will result in this error.)
	-Channel Configuration Errors-
31	Instrument is not configured for destination control.

Table 3-9. Error Numbers and Description Listings for the HP 8904A's Help Messages (2 of 3)

Error Number	Description
-Hewlett-Packard Interface Bus (HP-IB) Errors -	
41	HP-IB numeric input error. Exponent too large or improper number format.
42	HP-IB numeric input error. The number was too large or too small, or a negative value was received when a positive value was required.
43	A number value was sent via HP-IB when one was not expected.
44	Invalid unique data was input via HP-IB. (Unique data specifies the Waveform, Modulation Type, Modulation On/Off Control, and Filter Selection, when entering a data string via HP-IB.)
45	Unique data was received via HP-IB when none was expected. (Refer to Error 44 for an explanation of unique data.)
46	An invalid terminator for the present data type was received via HP-IB. (A data terminator specifies the units of the data entered; i.e., Hz, Degrees, Volts, Seconds, Percent, etc; the ENTER command is also included in this group.)
47	A Data Terminator was received via HP-IB when none was expected. (Refer to Error 46 for an explanation of data terminators.)
48	A combination of errors 41 through 47 probably exists. (Confirm that at least one of these errors exists and correct it. Enter the data again and read any error messages that result; an error number other than 48 should be displayed. The second error message should help to further isolate the error until it is eliminated.)
-Signal Sequence Mode Errors-	
50	Time value entered is out of range.
51	On and Off Time values cannot both be zero.
52	Amplitude value entered is out of range.
53	Frequency value entered is out of range.
54	Tone Number entered is out of range. [Only tone numbers 0-F (Hexadecimal) are valid.]
55	Sequence Index value entered is out of range. (Valid Range is 1-250.)
56	Sequence End value entered is out of range. (Valid Range is 1-250.)
57	The number entered is not valid in the Sequence Base selected. (Either the Binary, Octal, or Hexadecimal base numbering system is used to specify the Sequence Index and Sequence End. For example, you may not use the character '9' when you have previously specified the Octal base, since this number does not exist in that numbering system.)
58	Command not permitted in this mode.
59	Command not available in present window.
-Destination Control Errors-	
101	Channel A cannot be used as a source for AM, FM, DSB, Phase or Pulse modulation. (Channel A can be modulated, but it cannot be used as a modulation source.)
102	Channel A has a Waveform of dc and cannot be modulated.
103	A channel which has a Waveform of dc cannot be used as a modulation source.
104	An operation was directed to an output board which does not exist.

Table 3-9. Error Numbers and Description Listings for the HP 8904A's Help Messages (3 of 3)

Error Number	Description
105	AM and DSB are mutually exclusive modulations and one is already active.
106	An attempt was made to use a second summer. For this configuration of two summers, only channels A+B with channels C+D is permitted.
107	The Hop Ram is presently enabled as this modulation source.
108	The Frequency set value selected is greater than the permitted maximum for pulse modulation.
109	The Frequency set value selected is greater than the permitted maximum for this waveform.
110	Either AM or DSB modulation is active so Amplitude Hop Ram cannot be changed.
111	The present value of the Hop Ram amplitude settings will exceed the maximum permitted value and therefore the Amplitude Hop Ram cannot be turned on.
112	The present value of the Hop Ram frequency settings will exceed the maximum permitted value and therefore the Frequency Hop Ram cannot be turned on.
113	The attempted Frequency Hop Ram set value is greater than the permitted maximum for this waveform.
114	Phase modulation is presently active, therefore Phase Hop cannot be changed.
115	The present Channel A waveform cannot be used at the present frequency setting of Channel A if the Frequency Hop Ram is disabled.
	-Miscellaneous Errors-
121	The amplitude value selected is greater than the permitted maximum.
122	The amplitude value selected results in a sum which is greater than the maximum permitted value.
123	The frequency value selected is greater than the maximum permitted value.
124	When the Amplitude Hop Ram was disabled, the last Channel A amplitude setting could not be used with present instrument parameters. (Adjust the the Channel A amplitude to within non-Hop-Ram limits.)
150	The selected Waveform cannot be generated at the present frequency setting.
151	The dc Waveform can only be selected for a channel which has an Output Port or Off as a destination.
152	Channel A Waveform cannot be changed to dc while being modulated.
153	You can sum only one channel with a dc Waveform into an output board, and one is already active.
155	The Sync Clock signal needed for phase synchronization is not present.
160	An operation was directed to an output board which does not exist.
200	The Tone Frequency only has a range of 20 Hz to 15 Hz
201	The Pilot Level maximum in 100%.

3-9. SPECIAL FUNCTIONS

Introduction

The special functions alter the instruments operating 'environment' in order to change how the instrument responds to changes in different instrument settings or operating conditions. These functions perform simple operations, such as disabling the beeper, and more complex functions, such as disabling the automatic phase reset in the Digital Synthesis IC.

NOTE

*Special Functions can only be changed when the instrument is at the Main Selection Level. Performing an instrument **PRESET** turns off all special functions. Using the **MAIN** key does not effect specials.*

Enabling and Disabling Special Functions

From the Main Selection Level, press the **SPECIAL** key. Use the **NEXT** and **LAST** keys to scroll through the list of specials. When the special you are changing is displayed, press **f2** and **ON** or **OFF** to enable or disable that function. Exit the **SPECIAL** menu by pressing the **f4** key.

Special 0: Last State Recalled on Power Up

Enabling this function tells the instrument to remember the instrument settings that are present when the unit is turned off. When the instrument is turned back on, the same settings are automatically selected. This effectively provides a dedicated store/recall register to eliminate the need to reenter the same settings.

Special 1: Disable Automatic Phase Reset

When operating 'normally' in the Channel Configuration mode, the HP 8904A resets the relative phase of each channel to zero(0) whenever the frequency or destination of any channel is changed. (However, any phase offset that has been specified is maintained). All signals with a phase setting of zero(0) are reset to a zero-crossing point in their respective waveforms, regardless of the phase relationship that existed before the change occurred.

Enabling this special function prevents the phase reset from occurring. As the frequency or destination of one channel is changed, the phase of the other channel(s) is not disturbed. Even when you do change the frequency of a channel, the phase angle of that channel is not changed. This allows for phase-continuous operation of the HP 8904A.

This effect can be demonstrated by displaying a 0.5 Hz sinewave on an oscilloscope and then changing the frequency in 0.1 Hz increments. When this special is off, the phase resets to zero(0) when the frequency is changed; when the special is on, the phase does not change as the frequency is changed.

Special 2: Disable Beeper

The beeper normally beeps twice when the instrument is powered up, and then beeps once any time an error occurs during operation. Enabling this special prevents the beeper from working in either case.

Special 3: Reverse Modulating Waveforms

The modulating waveform is reversed to provide alternate modulating schemes, especially when using the ramp. Normally the ramp waveform starts at the negative peak and ramps up to the positive peak. This special function reverses the ramp when used as a modulating source by starting the waveform at the positive peak and ramping down.

Sine, triangle, and square modulating waveforms are also reversed, but the effect is not as noticeable since they are symmetrical waveforms.

Special 4: Disable Output Blanking

When the amplitude of a signal being output is changed enough to cause a change in the setting of the discrete attenuators on the output board, the signal is normally shut off or 'blanked' to prevent switching transients from being output during the change. The blanking normally lasts about 14 msec.

Enabling this special tells the instrument to continue to output the signal during the process of changing the attenuators, thereby reducing the amplitude switching time to about 2 msec., but allowing any switching transients that may be present to be output in the process.

Special 5: Floating Outputs on Power Up:

You can pre-define whether the output(s) will be floating or chassis ground referenced when the instrument is powered-up.

Special 6: Enable Synchronous mode:

Available only with Option 005 - Phase Synchronization. See section 3A for additional information.

Special 7: Configure as Master Controller:

Available only with Option 005 - Phase Synchronization. See section 3A for additional information.

3-10. OPERATING TECHNICAL REFERENCE

Waveform Jitter

The HP 8904A generates waveforms through a sampled digital process. The output clock frequency for the digital-to-analog conversion process is approximately 1.67 MHz. By Nyquist's theorem, we can conclude that the maximum possible frequency for the HP 8904A would be $\frac{1.67 \text{ MHz}}{2}$ ($\approx 800 \text{ kHz}$).

Because it is impossible to build an analog filter which has infinite cutoff slope, the maximum frequency is limited to 600 kHz to accommodate a realizable filter.

Sinewaves produced by this process will have excellent time stability, however, square, ramp, and triangle waveforms will have Jitter. The value of this jitter will be one clock cycle of the DAC: $\frac{1}{1.67 \text{ MHz}}$ ($\approx 600 \text{ ns}$) for square and triangle waveforms. This value doubles to 1200 ns when using ramp waveforms due to the fact that there is only one fast transition per cycle of this non-symmetrical waveform. Jitter occurs when the frequency of these waveforms is not harmonically related to the DAC clock frequency (which is exactly $\frac{2^{24}}{10}$ or 1,677,721.6 Hz).

For example, if we choose a frequency of 24.5 kHz, this frequency divided into the clock yields a non-integer relationship (68.47). Therefore the fast edges of the square or ramp waveforms, and the peaks of the triangle wave, do not always align with the clock. The result of this is that an occasional fast transition occurs one DAC cycle before or after the correct time. This causes a maximum jitter of 600 ns.

Unlike other types of jitter, the jitter produced by the HP 8904A does not occur on every cycle, and the severity of the jitter is predictable by calculating how far from a perfect frequency relationship a particular waveform is from the clock frequency. If we chose a different frequency, such as 23.3 kHz, the jitter will be almost zero because the frequency relationship is nearly integral: 72.005. Since this frequency is harmonically related to the clock frequency the fast edges almost always coincide with the output clock of the DAC.

All sampled synthesizers have this jitter. For the HP 8904A, all waveforms have this jitter except sinewaves (of course DC and noise do not either). The sinewave has no instantaneous transitions and therefore has no jitter. In addition, the trigger outputs (both the polarity and zero crossing outputs from the Digital Port) will always have jitter; again, depending on the frequency selected, even if the waveform being produced is a sinewave.

Fine Amplitude Resolution

The HP 8904A appears to have $3\frac{1}{2}$ digits of available resolution when viewed from the front panel. However, the available resolution is much better than what is shown. The displayed resolution was limited to $3\frac{1}{2}$ digits due to display constraints. There are actually 2048 available amplitude steps for each attenuator range. To understand how this works, an explanation of the implementation of the HP 8904A's amplitude control is needed.

All fine amplitude setting for the HP 8904A are handled in the digital domain using the Digital Waveform Synthesis IC. A very high performance 12 bit by 12 bit multiplier is available in this integrated circuit. Normally the multiplier is used for various types of amplitude modulation. It is also used to scale the amplitude of waveforms for summing, and to provide the fine level settings.

The analog output board has several attenuators which provide the large amplitude steps. The available attenuators are: 6 dB, 12 dB, 24 dB, and 48 dB. Various combinations of these attenuators are used to provide amplitude steps of approximately 6 dB (they are exactly $\frac{1}{2}$ of the previous scale which is -6.02 dB). The following table shows the output voltage ranges and which combination of attenuators are used for each.

Table 3-10. Output Amplitude Ranges and Their Associated Attenuators for the HP 8904A

Output	Voltage	Range	Analog Attenuation	Attenuators Used	Actual Resolution
10.00	to 5.01	V	0	none	2.4414 mV
5.00	to 2.51	V	6.02	6 dB	1.2207 mV
2.50	to 1.251	V	12.04	12 dB	0.6104 mV
1.250	to 0.626	V	18.06	6, 12 dB	0.3052 mV
0.625	to 0.313	V	24.08	24 dB	0.1526 mV
0.312	to 0.1564	V	30.10	6, 24 dB	76.2939 μ V
0.1563	to 0.0782	V	36.12	12, 24 dB	38.1470 μ V
78.13	to 39.1	mV	42.14	6, 12, 24 dB	19.0735 μ V
39.06	to 19.6	mV	48.16	48 dB	9.5367 μ V
19.53	to 9.766	mV	54.18	6, 48 dB	4.7684 μ V
9.765	to 4.883	mV	60.21	12, 48 dB	2.3842 μ V
4.882	to 2.442	mV	66.22	6, 12, 48 dB	1.1920 μ V
2.441	to 1.222	mV	72.25	24, 48 dB	1.0000 μ V
1.221	to 0.611	mV	78.27	6, 24, 48 dB	1.0000 μ V
0.610	to 0.306	mV	84.29	12, 24, 48 dB	1.0000 μ V
0.305	to 0.153	mV	90.31	6, 12, 24, 48 dB	1.0000 μ V

The multiplier is used to "fill-in" the fine level steps between the 6 dB analog attenuator steps. Approximately half of the 12 bit scale of the multiplier is used for setting the fine levels. This means that for each 6 dB wide window there are 2048 possible fine amplitude steps:

$$2^{12} = 4096: \frac{4096}{2} = 2048$$

While this arrangement yields a constant number of steps per 6 dB attenuator range, the resolution in volts is twice as fine for every 6 dB attenuator used. For example, the actual resolution in the 10 to 5.01 V range is:

$$\frac{10V - 5V (\text{next full scale range})}{2048 \text{ steps}} = \frac{5}{2048}$$

$$\text{Resolution} = 2.441 \text{ mV}$$

For the 5 to 2.51 V range the resolution is:

$$\text{Resolution} = \frac{2.5V}{2048 \text{ steps}}$$

$$\text{Resolution} = 1.222 \text{ mV}$$

The minimum resolution is limited to 1 μ V for the bottom of four ranges. As mentioned before, this fine resolution is not displayed on the front panel due to lack of display space. Steps this fine may be programmed over HP-IB or input from the front panel. To get small steps from the front panel, the amplitude increment function must be used. For example, on the 10 volt full scale range an amplitude increment of 2.44 mV could be set. The the amplitude can be stepped up or down by this amount using the \uparrow or \downarrow keys. The display does not change, however, until enough steps have occurred to alter the $3\frac{1}{2}$ digits of displayed resolution.

Filters

Since the HP 8904A generates waveforms as digital words, a low-pass filter must be used to reconstruct the waveform to remove the high frequency energy that is present. The Nyquist Theorem states that to fully recreate a waveform, the sampling rate must be twice the highest frequency component in the waveform.

The HP 8904A samples at 1.67 MHz and allows frequencies up to 600 kHz. This is a ratio of 2.783:1, allowing a margin for Nyquist's required 2:1. The digital output contains the spectrum shown in the following drawing.

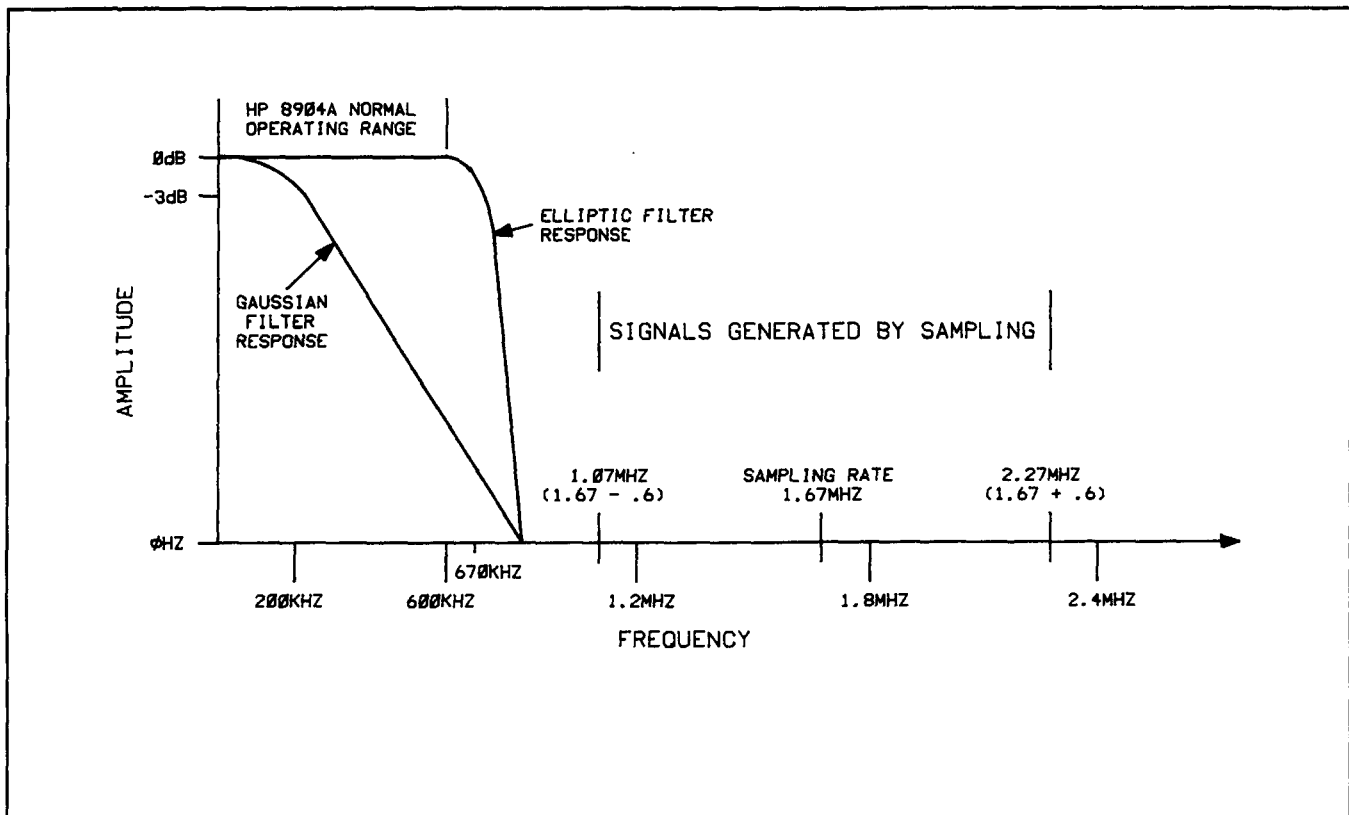

Figure 3-14. Spectrum of Signals Created by the HP 8904A

A filter must be used to remove the high frequency images grouped around the sampling frequency and its harmonics. In the HP 8904A there are two filters used for this purpose; an elliptic filter, and a gaussian filter.

- The elliptic filter has excellent flatness, with a -3 dB cutoff at 670 kHz and a very steep cutoff slope.
- The gaussian filter has excellent group delay linearity but has a gentle cutoff slope and a -3 dB cutoff at 200 kHz.

Filter Selection

In normal operation, the HP8904A automatically selects one of the two filters, based on the waveforms and frequencies used. The elliptic (sharp cutoff) filter is used for sinewaves and noise, and any time a frequency > 50 kHz is output. The gaussian (low overshoot) filter is used for triangle, square, and ramp waveforms, and for pulse modulation. The elliptic filter can cause considerable ringing on transient waveforms. However, the gaussian filter does not cause ringing.

Although the automatic filter selection algorithm normally picks the optimum filter, there are cases where you may want to manually pick one of the two filters. For example, you may want to limit the bandwidth of the noise waveform. By using the gaussian filter, the noise bandwidth can be lowered from 600 kHz to 200 kHz.

Manual selection of filters is accomplished by pressing the **FILTER** key, and then entering the output number you are using (1 for standard instruments, 1 or 2 for Option 002 equipped instruments). When the output number is entered, the filter that is presently active for that output is displayed. You can then use the **f1** key to select the other filter and enable or disable the automatic filter selection function if desired.

Phase Resolution

The nominal phase resolution for the HP 8904A is 0.1 degrees. This is the smallest increment which can be entered from the front panel or over HP-IB. The actual phase resolution of the hardware is better than the 0.1 degree limit.

A 12 bit word is used in the Digital Waveform Synthesis IC to set the phase of each channel. Since the phase range is 0 to 359.9 degrees, each bit in the twelve bit phase word represents a phase increment of 0.08789063 degrees. Since the resulting phase resolution from the digital process is not an exact value, the instrument firmware limits the resolution to 0.1 degrees. The HP 8904A attempts to set the phase as close as possible to the requested value using the available phase resolution. This means that for any given phase offset there will be a predictable error caused by the non-exact phase resolution of the hardware. In any case, the maximum value of the error due to the resolution can be mathematically shown to be one half of the hardware resolution: 0.04394531 degrees.

Although the phase resolution is 0.1 degrees, there are some cases where the phase resolution can be degraded. Sinewaves and triangle waves always have 0.1 degrees of phase resolution at all frequencies. However, the ramp and squarewave waveforms can have reduced phase resolution at certain frequencies. These special frequencies are EXACT sub-multiples of the digital-to-analog converter clock rate of $\frac{2^{24}}{10} = 1.6777216$ MHz. These are the frequencies where the squarewave has no jitter and the ramp waveform has greatly reduced jitter. (Refer to the *Jitter* information discussed earlier in this section). Example frequencies are: 26,214.4 Hz, 13,107.2 Hz, 6,553.6 Hz, 3,276.8 Hz, 1,638.4 Hz, 819.2 Hz, and 409.6 Hz. The phase resolution at these frequencies is limited because the nearly instantaneous transitions in these waveforms can only occur at the clock rate.

For example; at 26,412.4 Hz, one degree of phase equals 105.169 ns of time:

$$\text{Time for 1 degree} = \frac{1}{(26,412.4 \text{ Hz} \times 360 \text{ degrees})} = 105.169 \text{ ns}$$

However, the DAC clock can change its output every $\frac{1}{1.6777216 \text{ MHz}} = 595.046$ ns. This means that for the phase to change at all, the phase must be moved 5.66751 degrees. In other words, the phase must be advanced enough so that the transition portion of the waveform can move forward or backward to the next DAC clock. This effect reduction in phase resolution is reduced by one-half for each successive exact frequency which is lower in frequency. This effect of reducing the phase resolution does not effect square or ramp waves at other frequencies because the jitter present averages out the switching point of the fast transitions and therefore allows small changes in phase. This process is analogous to the use of dithering with noise in digital-to-analog converters.

Phase Continuous Switching

In the Channel Configuration Mode, the HP 8904A does not normally provide phase continuous frequency or amplitude switching. In normal operation, the HP 8904A performs a "phase reset" whenever the frequency or destination of any of the four channels is changed. This is done to assure that the proper phase relationships between channels will be maintained. The phase reset brings all the channels into phase alignment, but in doing

so causes a glitch. Any phase offsets have specific meaning when the frequencies of the four channels are harmonically related. If the channels are at non-harmonically related frequencies, the phase reset will cause all the channels to reset to zero phase (or the specified phase offset, if any). From that point, the channels will each continue on accumulating phase at their own rate. If phase continuous frequency switching is desired, special function #1 can be activated. This special function will disable the automatic phase reset so that frequency switches will be phase continuous. Activating this special will, however, result in operation where the specified phase relationships of the four channels will not be valid. To overcome this, the user can perform a manual phase reset to realign the channels from the front panel by pressing the blue shift key and the the f3 softkey.

Amplitude switches in the Channel Configuration Mode are also not phase continuous. When the amplitude is changed, the output will be blanked for approximately 13 ms. This is done so that amplitude glitches resulting from changing analog attenuators will not be allowed to reach the device under test. There are two methods of achieving glitch free amplitude switches with the HP 8904A. The first method is to use special function #4. This special disables the output blanking function. With special function # 4 active, amplitude switches within a given analog attenuator range will be phase continuous (see Amplitude Resolution for details on these ranges). When an attenuator range is crossed, however, there will be a jump up or down in level depending on which attenuator switches first.. The second method is to use the capabilities of Option 003. Option 003 gives the HP 8904A the ability to fast hop the frequency, amplitude, or phase of channel A. Any amplitude hops using this fast hopping mode will glitch free. The HP 8904A fixes the analog attenuation range to accommodate the highest amplitude loaded into the HOP RAM memory. All lower amplitude values are created using the multiplier in the Digital Waveform Synthesis IC. The disadvantage of using this method is that for large amplitude jumps (> 6 dB), fewer bits will be used which degrades the accuracy and residual distortion of the waveform.

In the Tone Sequence and DTMF Sequence Modes, the HP 89044A will perform phase continuous switches between frequencies if no off time is specified between tones. If some off time has been specified, the HP 8904A will cutoff the sinewave at the set time (regardless of where the switching point will be) which will cause an audible click in the waveform. This is caused by the sudden drop to zero volts which is composed of high frequency energy. If this glitch is not desired, the on and off times specified must be modified so that the switching will occur at a zero crossing.

3-11. MENU MAP

The Menu Map illustrates the various menus for all options of the HP 8904A. It is intended to help you familiarize yourself with the organization of the menus and the steps required to perform each function. Different menus are accessed by using the keys in the **DISPLAY** area of the front panel.

Selecting Menus

The Channel Configuration and Sequence menus are accessed by using combinations of the **f1**, **f3**, and **NEXT** keys.

Different levels of each menu are selected using the **NEXT/LAST** keys.

You can always return the instrument to the Main Menu level by using the **SHIFT** and **MAIN** keys.

Menu Changes When Using HP-IB Control

If you are using remote control via the HP-IB, the menu on the display only reflects the "mode" the instrument is in, and does not show the values for each field being changed. For example, if the controller tells the instrument to go to mode 0 by using the command **GMO**, the instrument displays the Channel Configuration Mode menu but does not change as you specify parameters for the different channels. To look at the parameters as they are being changed, you must manually select the affected menu.

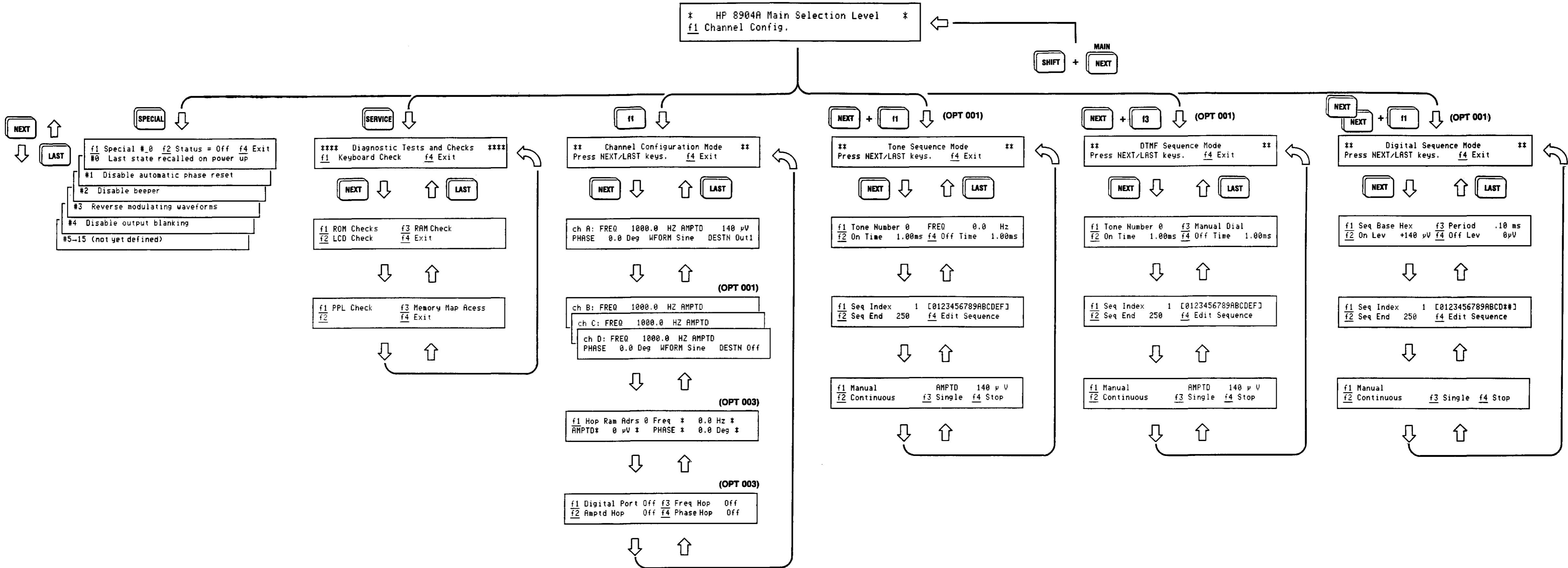

HP 8904A Multifunction Synthesizer

Basic Operation and Application

HP 8904A Operation Made Easy!

 HEWLETT
PACKARD

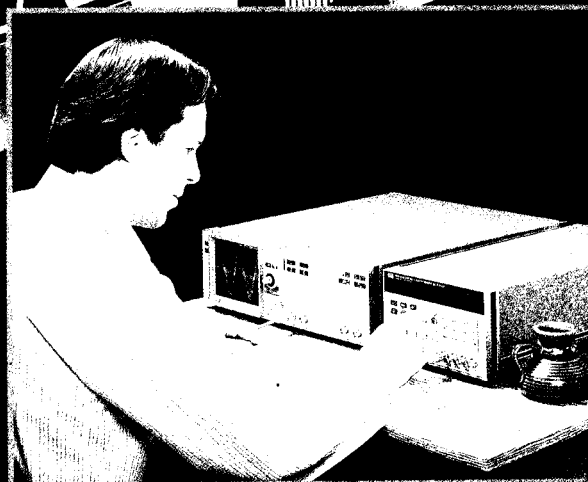

Table of Contents

1. Meet the HP 8904A

Learn how to operate your HP 8904A.

Option 01

2. Modulate or Sum the Signals

Learn how to use the many modulation and summation capabilities provided by an HP 8904A equipped with four channels.

3. Output a Sequence of Signals

Learn how to output a sequence of Tone, Dual-Tone Multi-Frequency (DTMF) or Digital signals.

Option 02

4. Output Two Signals at Once

Learn how to operate an HP 8904A equipped with Dual Output Ports.

Option 03

5. Hop the Output Signal

Learn how to hop the frequency, amplitude and phase of the output signal.

Appendixes

A - Installation

B - Help Messages

C - HP-IB Codes

Index

1

Meet the HP 8904A

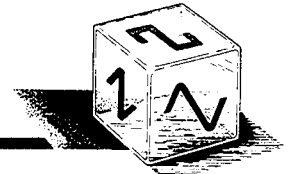

What is the HP 8904A?

The HP 8904A Multifunction Synthesizer is a flexible tool designed to meet your low frequency signal source needs by providing:

- A frequency range of dc to 600 kHz.
- Synthesized waveforms (sine, ramp, triangle, square, noise and dc).
- Operating modes that meet the needs of a wide range of audio test, modulation source and communication signaling applications.

Note

If you are unpacking a new HP 8904A, you will want to refer to the installation suggestions provided in Appendix A.

What's in this Guide?

This Operation and Application Guide begins by helping you determine which operating capabilities your HP 8904A has been equipped with.

Note

It is essential that you know which operating capabilities your HP 8904A has been equipped with in order to use this guide effectively.

The guide then helps you quickly learn to use your instrument's capabilities by guiding you through setup examples that demonstrate the HP 8904A's key features.

**Has Your HP 8904A
Been Equipped with
Additional Features?**

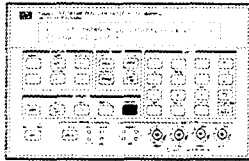

You can quickly determine if your HP 8904A has been equipped with optional operating capabilities by performing the following steps.

1. To power-up your HP 8904A, press the white LINE key.
2. Now press the blue SHIFT key and then the PRESET key. (The adjacent HP 8904A diagram shows the PRESET key location.) Each time the SHIFT, PRESET keys are pressed, the HP 8904A briefly displays its Preset display. This display lists the Configuration Options that your HP 8904A has been equipped with.

For example, the Preset display shown below indicates that all three Configuration Options (01, 02 and 03) are present. Note which options (if any) are listed in the Preset display on your instrument.

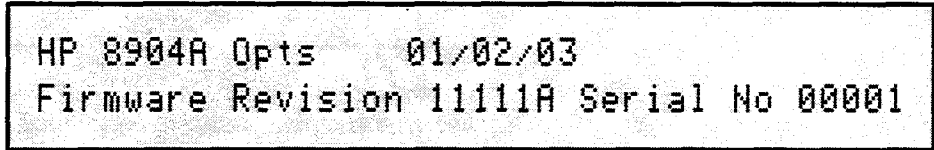

Once you have determined which options your HP 8904A is equipped with, refer to Table 1-1 for an overview of the capabilities provided by your instrument's configuration.

Table 1-1. The Operating Capabilities Provided by the Configuration Options.

Configuration	Capabilities Provided
Standard (all HP 8904A's)	<p>One Channel</p> <ul style="list-style-type: none"> • A single, internal synthesized signal source capable of generating any one of six waveforms (sine, square, ramp, triangle, noise or dc). <p>One Output Port</p> <ul style="list-style-type: none"> • A single Output Port that can be configured for floating or chassis ground connections.
Option 01	<p>Four Channels</p> <ul style="list-style-type: none"> • Four internal synthesized signal sources each capable of generating any one of six waveforms. <p>Modulation</p> <ul style="list-style-type: none"> • Internal modulation using up to three modulation signals. <p>Summation</p> <ul style="list-style-type: none"> • Internal signal summation of up to four signals. <p>Three Signal Sequence Modes</p> <ul style="list-style-type: none"> • Sequential transmission of analog or digital signals for simulating communications signaling.
Option 02	<p>Two Channels</p> <ul style="list-style-type: none"> • Two internal synthesized signal sources each capable of generating any one of the six waveforms. <p>Two Output Ports</p> <ul style="list-style-type: none"> • Dual Output Ports that can each be configured for floating or chassis ground connections.
Option 03	<p>Hop Mode</p> <ul style="list-style-type: none"> • A synthesized signal source whose frequency, amplitude and phase setting can be changed in a <i>fast hopping</i> mode.

As an example, an instrument equipped with all three Configuration Options would have the following capabilities:

- Four Channels (Option 01).
- Signal Sequence Modes (Option 01).
- Two Output Ports (Option 02).¹
- One Channel (of the four) that could be hopped (Option 03).

¹ Note that each Output Port provides both a High and a Low connection. The operation of these connections will be demonstrated further later in this chapter.

HP 8904A Operation: A Guided Tour

In this chapter, you will learn how to output each of the HP 8904A's six waveforms.

If your HP 8904A is equipped with one of the Configuration Options (01, 02 or 03), you will also want to refer to Chapters 2 through 5 to learn to use the capabilities that they provide.

Table 1-2 provides a quick guide to the chapters you will want to look at to learn to operate your HP 8904A.

Table 1-2. Chapter Guide for the Various Configuration Options

If your HP 8904A has:	Then read through:
No Options	Chapter 1
Option 01 Only	Chapters 1, 2 and 3
Options 01 and 02	Chapters 1, 2, 3 and 4
Options 01, 02 and 03	Chapters 1, 2, 3, 4 and 5
Options 01 and 03	Chapters 1, 2, 3 and 5
Option 02 Only	Chapters 1 and 4
Options 02 and 03	Chapters 1, 4 and 5
Option 03 Only	Chapters 1 and 5

Note

You should complete the operating demonstrations contained in this chapter before referring to the remaining chapters no matter which Configuration Options you have. The operating information provided in this chapter is important to all HP 8904A configurations.

How to Begin

If you are now sitting comfortably in front of your HP 8904A, you are ready to begin. Start on the next page and follow the step-by-step guide to learning to operate your HP 8904A. You will soon discover how the HP 8904A can provide you with both the flexibility and precision needed for many signal source applications.

Key Features and Major Attractions

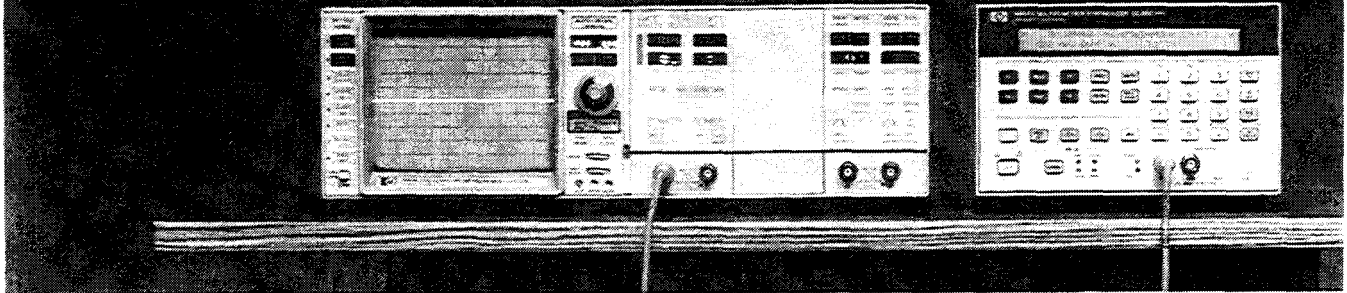

This chapter contains demonstrations that will help you learn how to:

- **Output a Signal**
- **Control the Output Port**
- **Save and Recall Your HP 8904A Settings**
- **Turn on the HP 8904A's Special Functions**

Set Up Your Equipment

Connect your HP 8904A to an oscilloscope as shown above.

Adjust Your Oscilloscope

Display	Channel A
Volts/Division	0.5V
Coupling	dc (High Impedance)
Time/Division	2 ms
Trigger	Channel A

Note

You will find that the back-lighting for the HP 8904A's display is designed to automatically turn off after approximately three minutes if no keys are pressed. The display will light when you press any key.

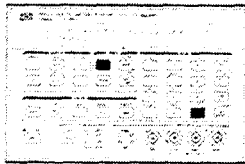

Select Chassis Ground

1. Press the blue **SHIFT** key and then the **PRESET** key.
2. Press the blue **SHIFT** key and then the **FLOAT** key.
3. Press the **1** key and then the **OFF** key. Note that the **FLOAT** annunciator (LED) for **OUTPUT 1** is now off. You have configured the HP 8904A's circuit ground to be referenced to chassis ground at **OUTPUT 1**. (The chassis-ground output configuration is used in this demonstration to minimize the set up requirements. You will learn more about the HP 8904A's chassis and floating ground configurations later in this demonstration.)
4. Adjust the oscilloscope's trace to center scale on the display.

How to Output a Signal

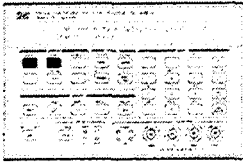

You are now ready to learn how quickly and easily the HP 8904A enables you to set up the output signals you desire.

1. Press the **f1 Channel Config.** softkey to enter the HP 8904A's Channel Configuration Mode. Figure 1-1 shows how to access the Channel Configuration Mode.
2. Press the **NEXT** key to advance the display ahead to the Channel A Configuration display.

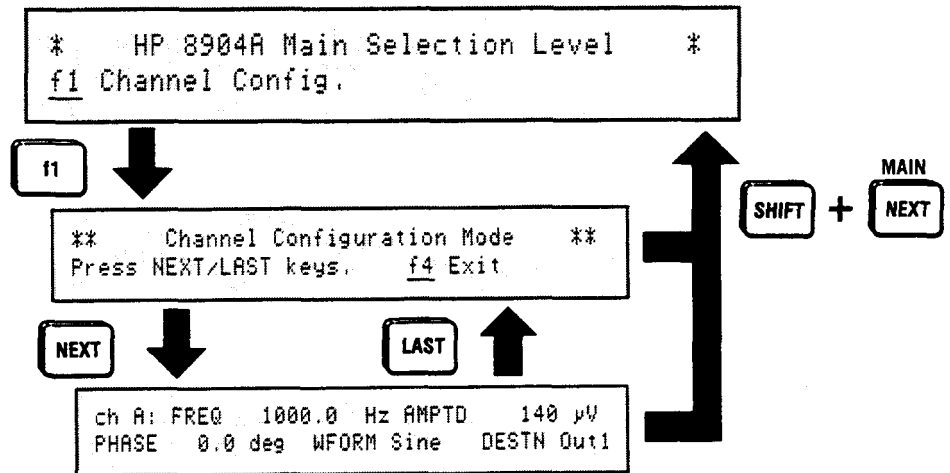
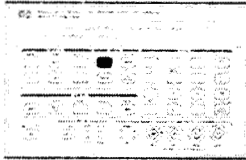

Figure 1-1. Accessing the Channel Configuration Mode is as Simple as Pressing a Key.

Enter a Frequency



3. Press the **FREQ** key to select the frequency entry field on the display. Notice that the parameter entry fields in the display and the four **SIGNAL** keys below the display have been arranged in the same order to help you quickly find the key you want.

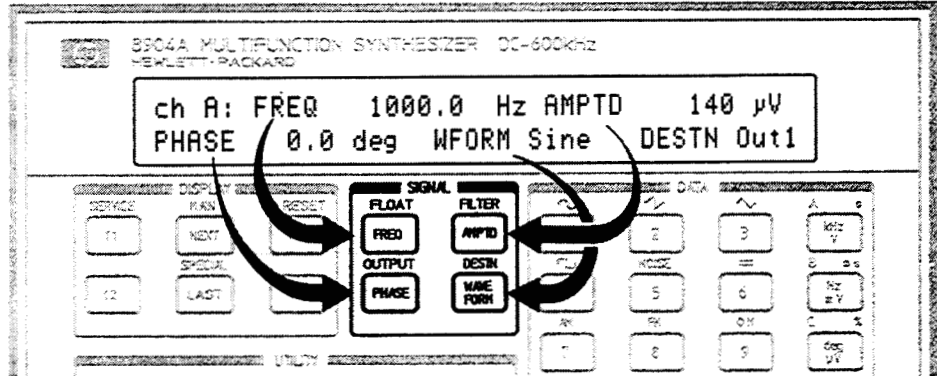

Figure 1-2. The Display Fields and Entry Keys are Similarly Positioned for Quick Access.

Note *If you enter a wrong digit, simply press the **←** key to backspace, and then re-enter the correct digit.*

4. Enter 120 Hz. (If your HP 8904A is operating on a 50 Hz power line rather than 60 Hz, enter 100 Hz for this demonstration.)

That's all you have to do to enter the frequency you desire for your output signal. Table 1-3 shows the frequency ranges provided by your HP 8904A.

Table 1-3. The Output Frequency Ranges of the HP 8904A.

Waveform	Frequency Range
Sine	0.0 Hz to 600 kHz
Square, Triangle, Ramp	0.0 Hz to 50 kHz
Noise	Random to 600 kHz
dc	0.0 Hz

Enter an Amplitude

5. Press the **AMPTD** key and enter **1V**. A 1V peak sinewave should now appear on your oscilloscope display. (Adjust the oscilloscope's triggering if needed for a stable display.)

With the HP 8904A, setting up your output amplitude is as easy as pressing the **AMPTD** key and entering the value you desire (0 to 10V).

Note

The amplitude level shown in the HP 8904A's display reflects the output signal level in peak volts when it is terminated by a high impedance input ($> 50\text{ k}\Omega$), and peak-to-peak volts when it is terminated by a $50\ \Omega$ input. (Throughout this demonstration, the oscilloscope is assumed to have a high impedance input.)

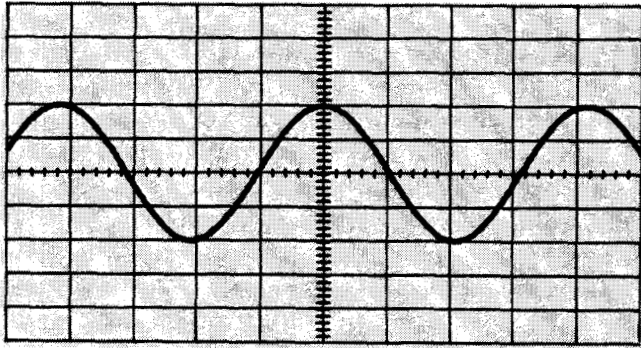

a. High Impedance Termination

b. $50\ \Omega$ Termination

Figure 1-3. Output Amplitude provided by the HP 8904A when set at 1V.

Select a Waveform

Selecting any one of the HP 8904A's six waveforms is just as easy.

6. Press the **WAVEFORM** key. You can now select any one of the HP 8904A's six waveforms. (Note that the sine waveform is the HP 8904A's default selection.)

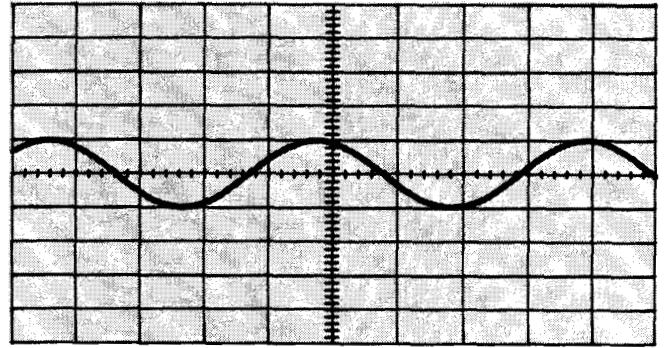
7. Press the \nearrow (ramp) key, the \wedge (triangle) key, the \sqcap (square) key, the **NOISE** key and then the \equiv (dc) key to output each of the five additional waveforms.

8. Now press the \sqcap key to select the square wave output.

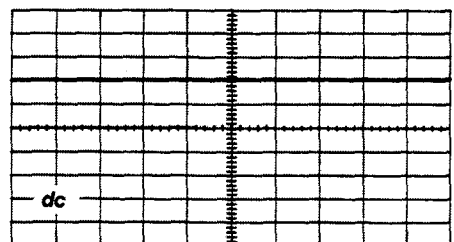
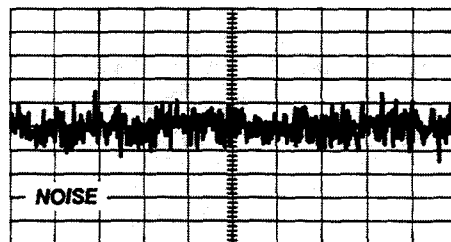
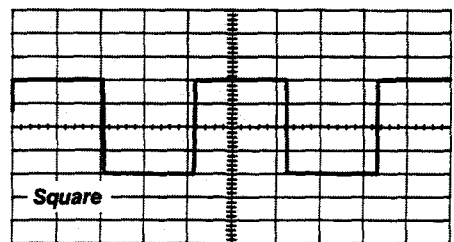
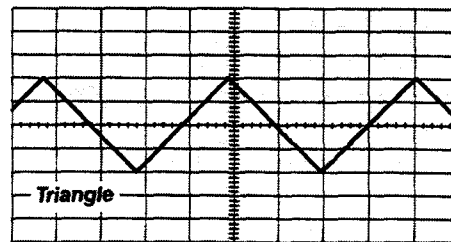
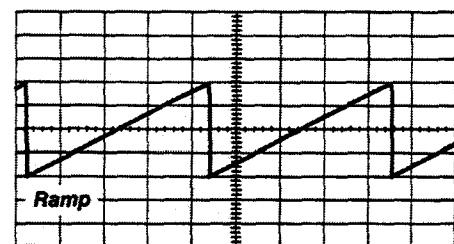
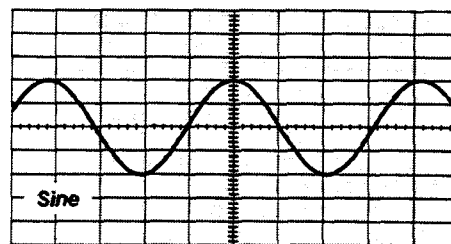
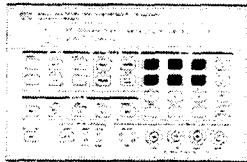

Now Vary the Phase

The HP 8904A allows you to vary the phase of your waveforms from 0 degrees to 359.9 degrees in step sizes specified by you.

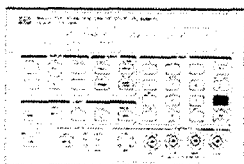
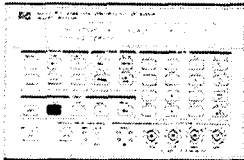

9. **Set the oscilloscope to trigger on the line voltage.** (You may need to adjust the oscilloscope's triggering in order to get a stable display.)
10. **Press the PHASE key and the INCR SET key on the HP 8904A.** Notice that the HP 8904A has placed an "is" in its display next to PHASE. This is to let you know that the value now being displayed is the increment set value rather than the current phase setting.
11. **Press 45 and the deg key to enter an increment step size of 45 degrees.**
12. **Now press the \uparrow key.** (Notice that the displayed waveform shifts each time the phase of Channel A is incremented. This is due to the resulting change in Channel A's phase relationship with the line voltage signal that is being used to trigger the oscilloscope.)
13. **Press the 0 key and the deg key to return the HP 8904A's phase setting to 0.0 degrees.**
14. **Set the oscilloscope to trigger on Channel A again rather than the line voltage.**

The HP 8904A allows you to vary the phase of its sine, square, triangle or ramp waveforms from 0 to 359.9 degrees in 0.1 degree steps.

That's how easy the HP 8904A makes it for you to create any of its six waveforms at the frequency, amplitude, and phase setting that you desire.

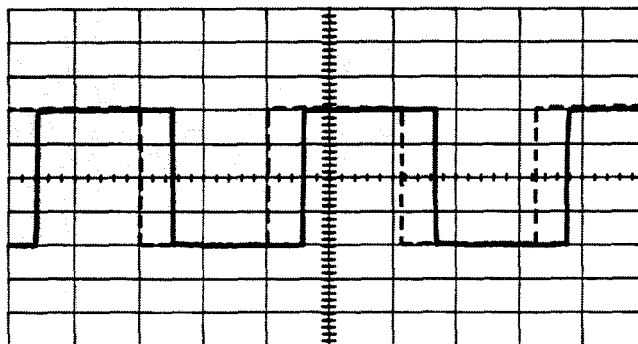

Figure 1-4. Precise 45° Phase Shift of the HP 8904A.

How to Control the Output Port

With the HP 8904A, you can choose either a *chassis ground* or a *floating ground* circuit configuration. The floating ground configuration allows you to reference the HP 8904A's ground to the ground level of the input device that the HP 8904A is connected to. You can also turn off the HP 8904A's output path to completely remove the output signal from the Output Port.

Figure 1-5 shows the HP 8904A's Output Port LEDs. These LEDs inform you of the current configuration status of each Output Port.

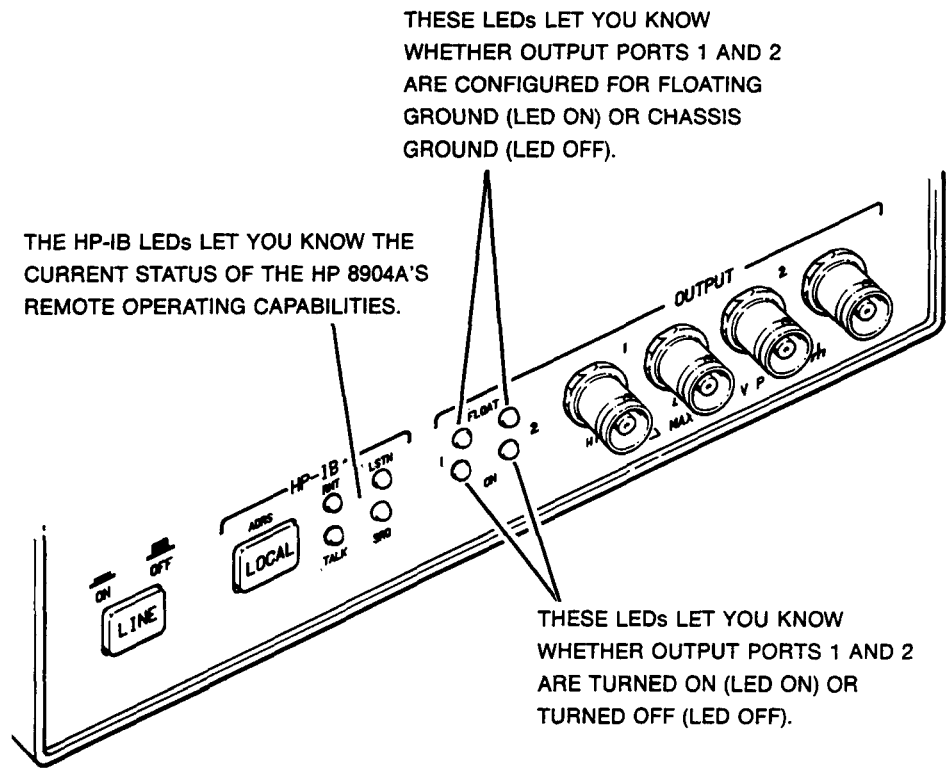
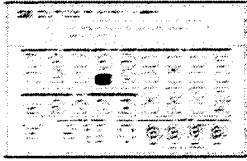

Figure 1-5. The Front Panel LEDs Inform You of the HP 8904A's Current Output and HP-IB Operating Status.

Turn Off the Output



1. Press the blue **SHIFT** key and then the **OUTPUT** key. The Output Control display should now appear on the HP 8904A.

Output On/Off Control
Enter output number = _ and ON/OFF

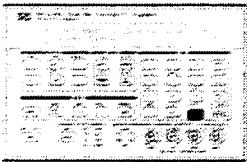

2. Press the **1** key. This designates which Output (1 or 2) you wish to control. (Output 2 can be turned "On" only when the HP 8904A is equipped with Dual Output Ports, Option 02.)
3. Press the **OFF** key. You have turned off Output 1. Note that the ON LED for OUTPUT 1 is no longer lit, and that the output signal no longer appears on the oscilloscope display. You have disconnected the output signal from the Output Port.

Note

The HP 8904A maintains a constant 50 ohm impedance at its output whether the output is on or off.

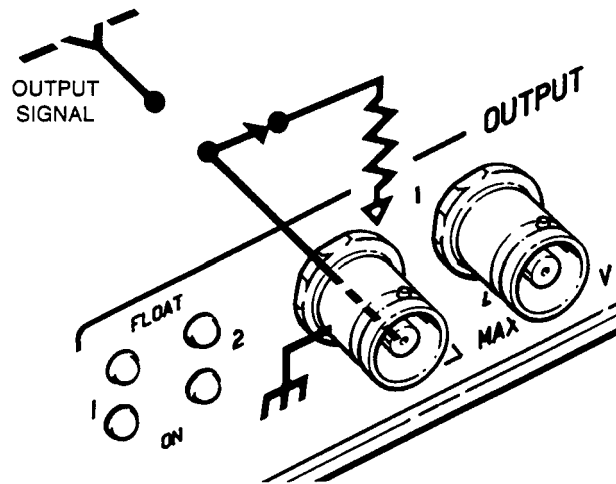
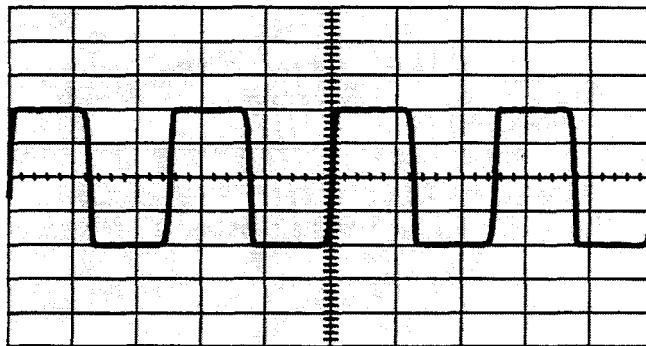
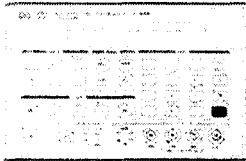

Figure 1-6. The Output Signal is Switched Away from the Output Port when the Output is Turned Off.

4. Now press the **FREQ** key and enter 20 kHz.
5. Press the **AMPTD** key and enter 10V. (Ten volts is the maximum output amplitude provided by the HP 8904A.)
6. Adjust the volts/division setting for Channel A on the oscilloscope to 5V, and the time/division setting to 20 μ s.
7. Press the blue **SHIFT** key and then the **OUTPUT** key to access the Output Control display.
8. Enter 1 and then press the **ON** key. Note that the ON LED for OUTPUT 1 is now lit.

Turn On the Output



Turning the HP 8904A's Output Port off can be useful when you wish to make changes to the output signal but you do not want the intermediate transitions present at the output.

Channel versus Output

In the HP 8904A, *Channel* refers to an internal synthesized signal source. The standard HP 8904A configuration provides a single channel. Instruments with Option 01 capabilities have four channels and those with Option 02 only have two channels. Each channel provides six waveform choices (sine, ramp, triangle, square, noise and dc).

Output refers to an HP 8904A Output Port. The standard HP 8904A configuration provides 1 Output Port. Option 02 adds a second Output Port.

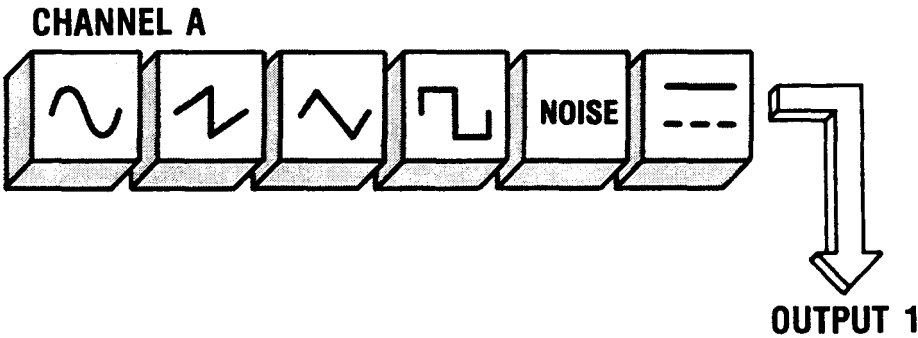

Figure 1-7. The Standard HP 8904A Configuration Provides One Channel and One Output Port.

Table 1-4 lists the channels and output ports provided by the Configuration Options.

Table 1-4. Channel and Output Port Configuration Options.

Options	Configuration
Standard (no options)	Channel A Output 1
01	Channels A, B, C and D Output 1
02	Channels A and B Outputs 1 and 2
01 and 02 (combined)	Channels A, B, C and D Outputs 1 and 2

Choose Between Chassis or Floating Ground

Chassis Ground

At the beginning of this demonstration, you configured the HP 8904A's circuit ground to be referenced to chassis ground. Figure 1-8 shows a simplified block diagram of the chassis ground configuration.

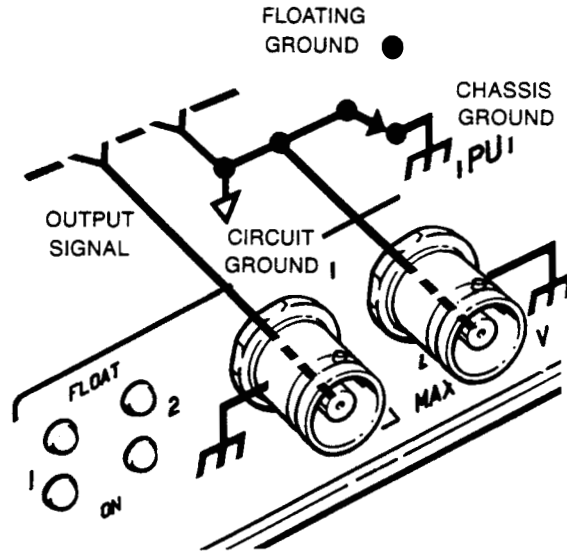

Figure 1-8. Circuit Ground is Connected to Chassis Ground when the FLOAT LED is Off.

Floating Ground

When the FLOAT LED is on for Output 1 or 2, the HP 8904A's circuit ground is not referenced to chassis ground at that output. (Floating ground is the HP 8904A's Preset, or default, output configuration.)

The floating ground configuration (LED on) allows the HP 8904A's circuitry to be referenced to an external ground rather than to chassis ground. This configuration eliminates ground loops between the HP 8904A and the input device. Figure 1-9 shows two methods for connecting the floating Output Port to an input device.

Caution

The voltage differential between the HP 8904A's floating ground level and its chassis ground level should not exceed a maximum of 10 Vpk.

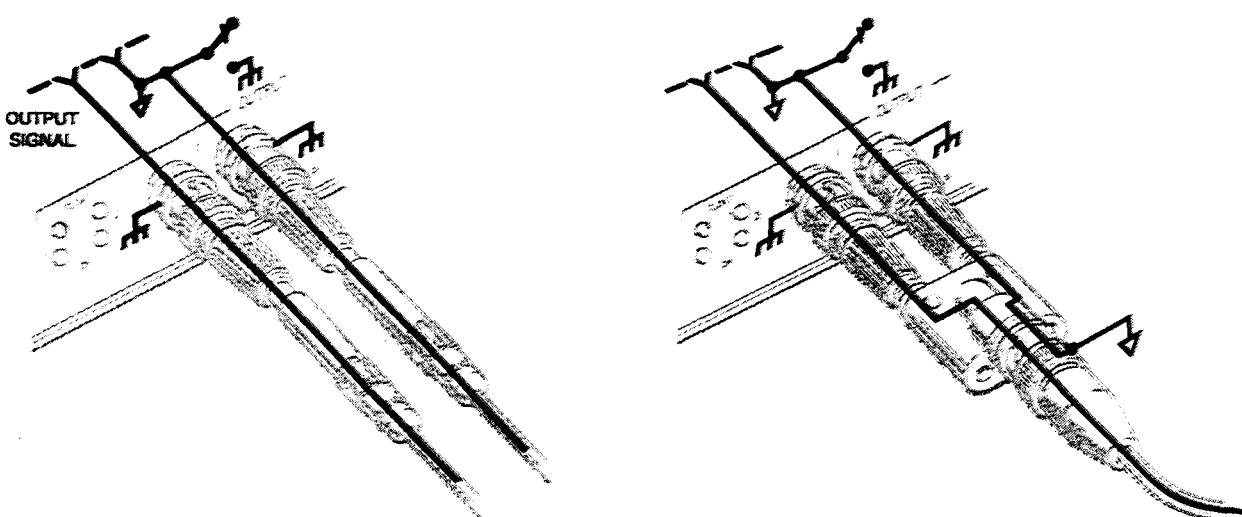

a. Using two BNC cables provides maximum shielding where High and Low inputs are also available.

b. Using an adapter allows the High and Low Output Ports to be connected to a single input port.

Figure 1-9. Cable Connections for the Floating Ground Output Configuration.

How to Save and Recall Your Settings

You can easily save all of the operating settings you have entered, and recall them whenever you wish.

Set Up a Save Register

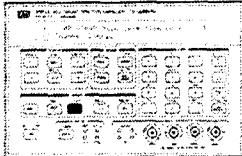

1. Press the blue SHIFT key and the SAVE key to access the Save Register display.

```
Save Register  ?  0 - 11 Are Valid
Enter register number and/or ENTER
```

2. Press the 1 key and then the ENTER key. You have stored *all* of the HP 8904A's current settings in Save Register 1. The HP 8904A provides 12 Save Registers (0-11).

Now Return to the Main Selection Level



3. Press the blue SHIFT key and the MAIN key. The MAIN key returns you to the HP 8904A's Main Selection Level display.

```
*  HP 8904A Main Selection Level  *
f1 Channel Config.
```

4. Press the **f1 Channel Config.** softkey to return to the Channel Configuration Mode.
5. Press the **NEXT** key to access the Channel A Configuration display. Note that each of Channel A's parameters were reset to their default settings when you re-entered the Channel Configuration Mode.

Remember

Whenever the HP 8904A exits the Channel Configuration Mode and then re-enters it or any other operating mode, all parameters are reset to their default settings.

Recall Your Settings

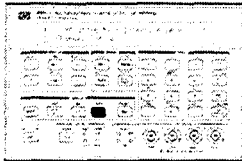

6. Press the blue **SHIFT** key and then the **RECALL** key to access the Recall Register display.
7. Press the **1** key and then press the **ENTER** key. The HP 8904A is now returned to the same operating state it was in when you set up Save Register 1.

```
ch A: FREQ 20.000 kHz AMPTD 10.00 V
PHASE 0.0 deg WFORM Sq DESTN Out1
```

Remember

When you Recall a Save Register, the HP 8904A returns all of its parameters (except Special Functions) to the same settings that existed when the Save Register was selected.

How to Turn On the Special Functions

Access the Special Functions

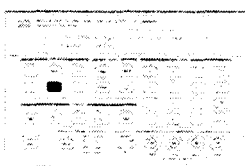

Turn On Special Function 0

The Special Functions permit you to modify the HP 8904A's operation to best meet your needs. In this demonstration, you will turn on the Special Function that configures the HP 8904A to power up to the state it was in before power was turned off, rather than to the Main Selection Level.

1. Switch the white **LINE** key off for a few seconds and then back on. Notice that the HP 8904A has powered up to the Main Selection Level.
2. Press the blue **SHIFT** key and the **SPECIAL** key to access the HP 8904A's Special Function display. This display allows you to turn on the HP 8904A's Special Function capabilities.

```
f1 Special #_0  f2 Status = Off  f4 Exit
# 0  Last state recalled on power up
```

3. Press the **f2 Status** softkey and then press the **ON** key. You have turned on Special Function 0. Notice "Status" now equals "On" in the display to let you know that Special Function 0 is now turned on. Special Function 0 enables the HP 8904A to power up to the operating settings that existed when power was turned off.
4. Press the **NEXT** key to step through the other Special Functions. Note that the Special number in the display increments each time you press the **NEXT** key. A brief description is displayed for each Special Function that is provided by your instrument.
5. Press the **f4 Exit** softkey to return to the Main Selection Level display.

Now Try Special Function 0

6. Press the **f1 Channel Config.** softkey and the **NEXT** key to access the Channel A Configuration display again.
7. Now switch the white **LINE** key off for a few seconds and then back on. Your HP 8904A should power back up to the same state it was in.

Main versus Preset

The HP 8904A always provides you with at least two methods for returning its operation to the Main Selection Level. It is important that you are aware of the effects that each of these methods has on the status of the HP 8904A's settings.

Save Registers are Retained

Special Functions are Turned Off

1. Press the blue **SHIFT** key and then the **PRESET** key. Both the **MAIN** key and the **PRESET** key return you to the Main Selection Level. The **PRESET** key however, resets the HP 8904A's functions to their pre-defined power-up condition, including the Special Function settings and Floating ground.
2. Press the blue **SHIFT** key, the **RECALL** key, the **1** key and then press the **ENTER** key. Note that the HP 8904A's Save Register settings are retained whether you use the **MAIN** key or the **PRESET** key (or even if the instrument is powered down).
3. Switch the HP 8904A's power **OFF** for a few seconds and then back **ON**. Since Special Function 0 was turned off when you pressed the **PRESET** key, the HP 8904A now powers-up to the Main Selection Level rather than the state it was in.

Table 1-5. Summary of how the **PRESET** and **MAIN** keys affect Operation.

Key	Function
PRESET	<ul style="list-style-type: none"> • Returns operation to the Main Selection Level. • Resets operating functions to their pre-defined power-up condition, including Special Function settings and Floating ground. • Does not reset Save Registers.
MAIN⁽¹⁾	<ul style="list-style-type: none"> • Returns operation to the Main Selection Level. • Does not reset Special Function settings, Save Registers or Floating ground.

(1) The **f4 E x i t** softkey's effect on operation is similar to that of the **MAIN** key.

Things to Remember

Congratulations, you are now familiar with the key operating capabilities that are standard to all HP 8904A's. Table 1-6 shows the final settings that you entered for Channel A in this demonstration. Similar tables are used in the remaining chapters to describe the channel configurations for various application examples.

From now on, when your application requires a function generator, modulation source or stimulus for audio circuit testing you can rely on the HP 8904A to provide the flexibility and accuracy that you need.

Table 1-6. The Channel A Settings from the Chapter 1 Demonstration.

CHANNEL	FLOAT	FREQ	AMPTD	PHASE	WAVE-FORM
A	Off	20 kHz	10V	0.0 deg	Square

Key Points About Operation

Table 1-7 contains operating considerations you should keep in mind as you operate your HP 8904A.

Table 1-7. HP 8904A Operating Considerations.

Operation	Considerations
Control Output Port	<ul style="list-style-type: none"> Floating ground (LED on) is the default output setting. The output impedance is 50Ω whether the Output Port is turned on or off.
Enter Amplitude	<ul style="list-style-type: none"> The displayed amplitude value represents peak volts when the HP 8904A is connected to a high impedance input or peak-to-peak volts when it is connected to a 50Ω input.
Output Noise	<ul style="list-style-type: none"> The Noise function provides pseudorandom, Gaussian white noise. The amplitude value you enter sets the peak output level of the noise.
Turn Off Special Functions	<ul style="list-style-type: none"> Special Function settings are turned off when the PRESET key is pressed, but not when the MAIN key is pressed.

To Learn More

If your HP 8904A is equipped with Option 01, 02 or 03, refer to the remaining chapters to learn more about operating your HP 8904A.

Table 1-8. Chapter Guide for the Various Configuration Options.

If your HP 8904A has:	Then refer to:
<i>Option 01 Only</i>	<i>Chapters 2 and 3</i>
<i>Options 01 and 02</i>	<i>Chapters 2, 3 then 4</i>
<i>Options 01, 02 and 03</i>	<i>Chapters 2, 3, 4 then 5</i>
<i>Options 01 and 03</i>	<i>Chapters 2, 3 then 5</i>
<i>Option 02 Only</i>	<i>Chapter 4</i>
<i>Options 02 and 03</i>	<i>Chapters 4 and 5</i>
<i>Option 03 Only</i>	<i>Chapter 5</i>

2

Modulate or Sum the Signals

Four Channel Operation

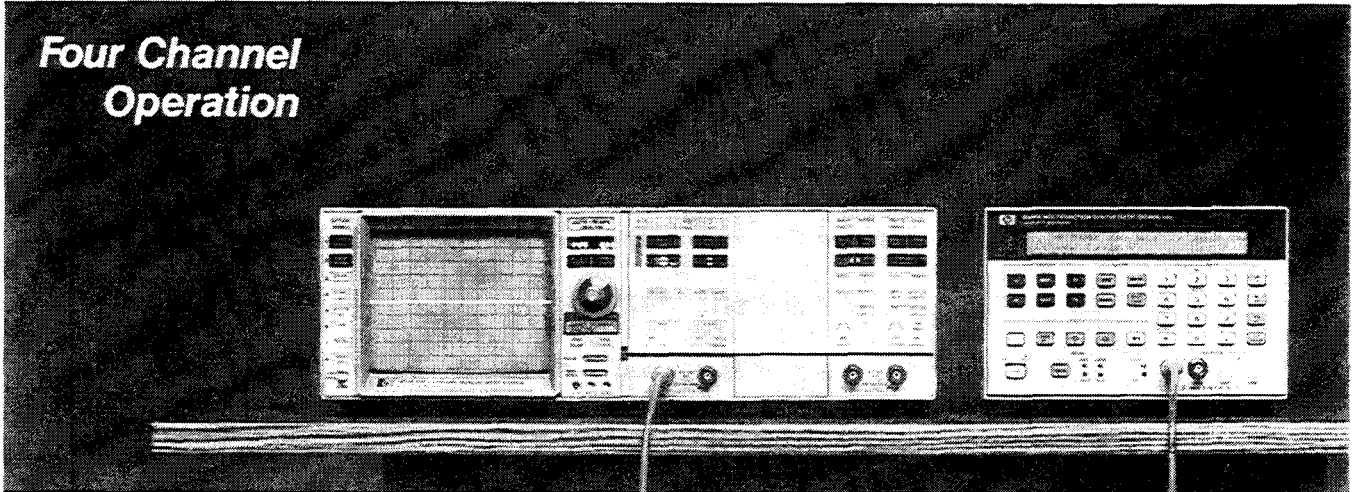

In This Chapter

This chapter will help you learn to use the four channels provided by Configuration Option 01. If your HP 8904A is equipped with Option 01, simply step through the following demonstrations to learn how to:

- **Modulate Channel A**
- **Set Up Simultaneous Modulation**
- **Sum the Modulation Signals**
- **Sum the Output Signals**
- **Set Up Some Multi-Channel Applications**

Set Up Your Equipment

Connect your HP 8904A to the oscilloscope as shown above.

Adjust Your Oscilloscope

Display Channel A
Volts/Division 1V
Coupling dc (High Impedance)
Time/Division 0.2 ms
Trigger Channel A

Select Chassis Ground

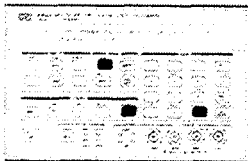

1. Press the blue **SHIFT** key and the **PRESET** key on your HP 8904A.
2. Press the blue **SHIFT** key and then the **FLOAT** key.
3. Press the **1** key and then the **OFF** key to reference the HP 8904A's circuit ground to chassis ground at Output 1. (Note that the **FLOAT** LED for Output 1 is now off.)
4. Adjust the oscilloscope's trace position if necessary to center scale.
5. Press the **f1** Channel Config. softkey.
6. Press the **NEXT** key to access the Channel A Configuration display.

Access the Four Channels

```
ch A: FREQ 1000.0 Hz AMPTD 140 µV  
PHASE 0.0 deg WFORM Sine DESTN Out1
```

7. Continue pressing the **NEXT** key to step through the **Configuration displays for Channels B, C and D**. These are the four channels provided by Option 01. Figure 2-1 shows how to access the four channels.
8. Continue to press the **NEXT** key until you have returned to the **Channel A Configuration display**. (If you have an instrument that is equipped with Hop Mode (Option 03), the two Hop Mode displays will appear following the Channel D display as you press the **NEXT** key. Chapter 5 contains information to help you learn about Hop Mode operation.)

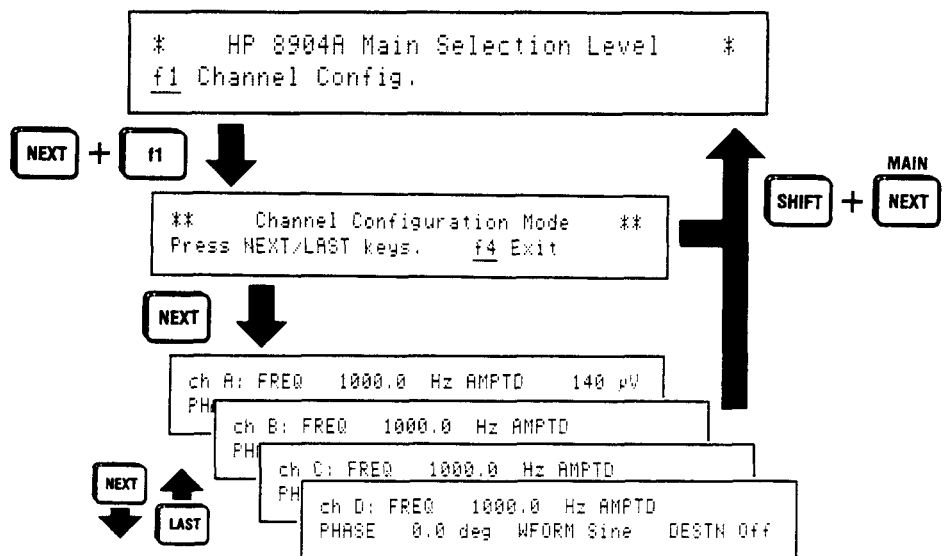

Figure 2-1. All Four Channels Can Be Accessed After You Have Pressed the f1 Channel Config. Softkey.

How to Modulate Channel A

The HP 8904A offers you a wide selection of modulation possibilities. In this demonstration, you will discover that you can create many useful signals by simply modulating Channel A with one other channel.

Set Up the Carrier

1. Press the **FREQ** key and enter 20 kHz as the Channel A frequency.

Note

*If you enter a wrong digit, simply press the **←** key to backspace, and then re-enter the correct digit.*

2. Press the **AMPTD** key and enter 2.5V. The 20 kHz, 2.5 Vpk Channel A signal should now appear on the oscilloscope display.

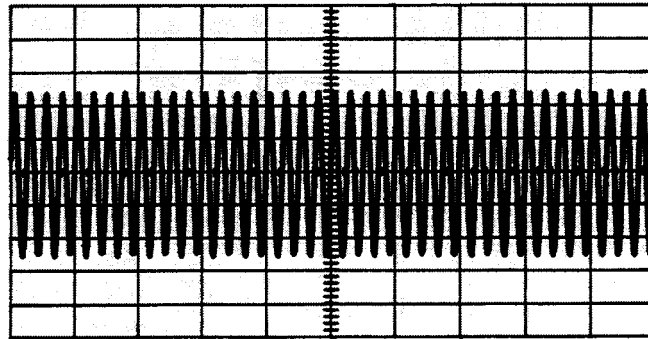

Set Up the Modulation Signal

Note

- Press the NEXT key to access the Channel B Configuration display.

Only Channel A can be modulated. However, any or all of the remaining channels (B, C and D) can be used for modulating Channel A.

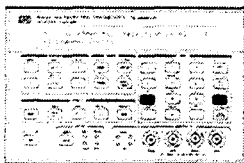
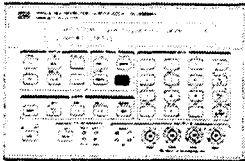

- Press the blue SHIFT key and then the DESTN key. The HP 8904A is now ready for you to specify how you want to use Channel B.
- Press the AM key to configure Channel B to amplitude modulate Channel A. Note that when you specified the destination, the HP 8904A changed the amplitude entry field in the display to the appropriate units (%) for the destination you have chosen (AM).
- Press the AMPTD key and enter 90%. The amplitude modulated sinewave should now appear on your oscilloscope display. (Adjust the oscilloscope's triggering if necessary to get a stable display.)

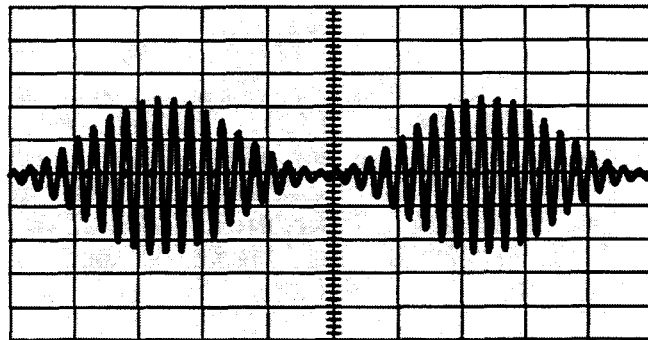

That's how easy it is to set up a modulated output signal using the HP 8904A.

Note

If the output signal no longer appears on the oscilloscope, and you pressed the DSB key, press the LAST key now to return to the Channel A display and re-enter 2.5V for the amplitude. Then press the NEXT key to return to the Channel B display.

The DSB key selects Dual-Sideband Suppressed-Carrier AM. The operation of this modulation mode and the effect it has on Channel A are described later in this demonstration.

**Now Look at
the Possibilities**

Change the Modulation Waveform

7. Press the WAVEFORM key and then the \sim (ramp), \wedge (triangle), \sqcap (square), and NOISE keys to see each of the other waveforms available for the modulation signal. (Adjust the oscilloscope's triggering if necessary to get a stable display.)

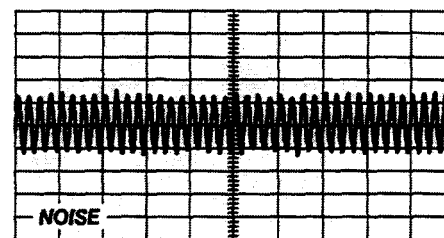
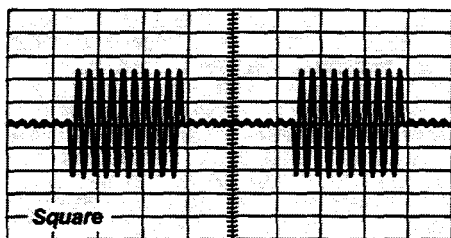
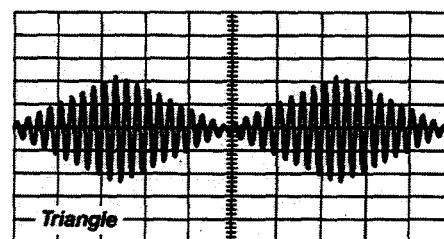
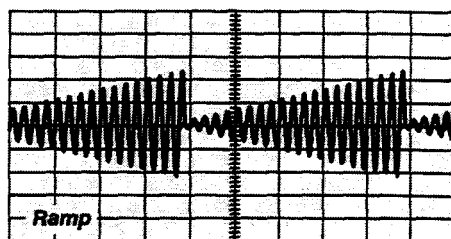

8. Press the \sim (sine) key.

Change the Modulation Mode

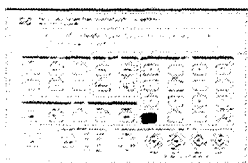

9. Press the blue SHIFT key, the DESTN key and the DSB key. You have selected Double-Sideband Suppressed-Carrier AM. The HP 8904A provides you with five modulation modes to choose from (AM, FM, Φ M, DSB and Pulse).

Remember

The HP 8904A always changes the amplitude setting to 140 μ V when the destination is changed; so remember to always specify your destination choice first then enter the amplitude setting.

10. Press the AMPTD key and enter 3V. Note that DSB modulation suppresses the carrier signal (Channel A).

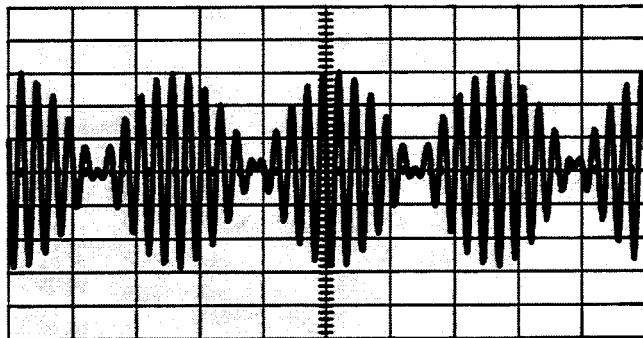

Change the Carrier Waveform

11. Press the **LAST** key to return to the **Channel A Configuration display**. Notice that "DSB" now appears in the amplitude field in the display to inform you that Channel A's output amplitude has been set (suppressed) by the DSB modulation.

```
ch A:  FREQ  20.000  kHz  AMPTD           DSB
        PHASE  0.0 deg  WFORM Sine       DESTN Out1
```

12. Press the **WAVEFORM** key and the \swarrow , \searrow , \ulcorner and **NOISE** keys. You can select any of these waveforms for the carrier signal.

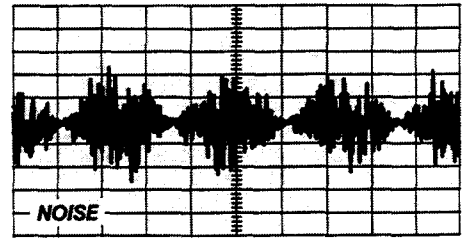
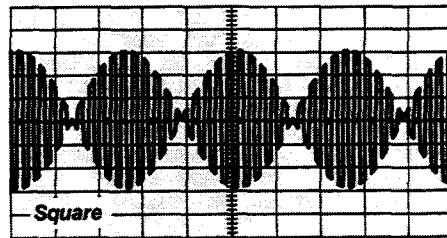
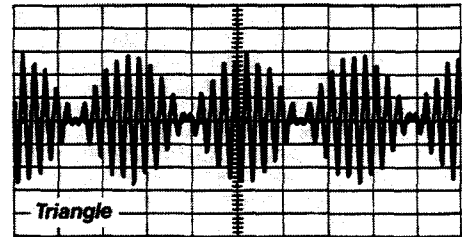
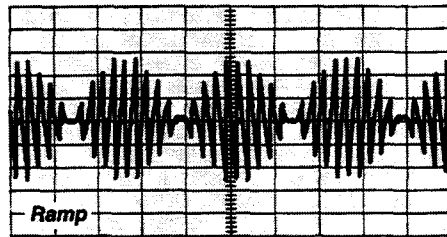

13. Press the \sim key.
14. Press the NEXT key, the blue SHIFT key, the DESTN key and the AM key.
15. Press the AMPTD key and enter 90%.
16. Press the LAST key. Notice that Channel A's amplitude setting has now been changed from the 2.5V you originally set to the 3V (DSB) setting.

Remember

When the DSB modulation mode is selected, the amplitude of the carrier (Channel A) is determined by the DSB amplitude setting.

As you can see, the HP 8904A offers you a wide selection of carrier and single source modulation possibilities. Figure 2-2 illustrates these possibilities.

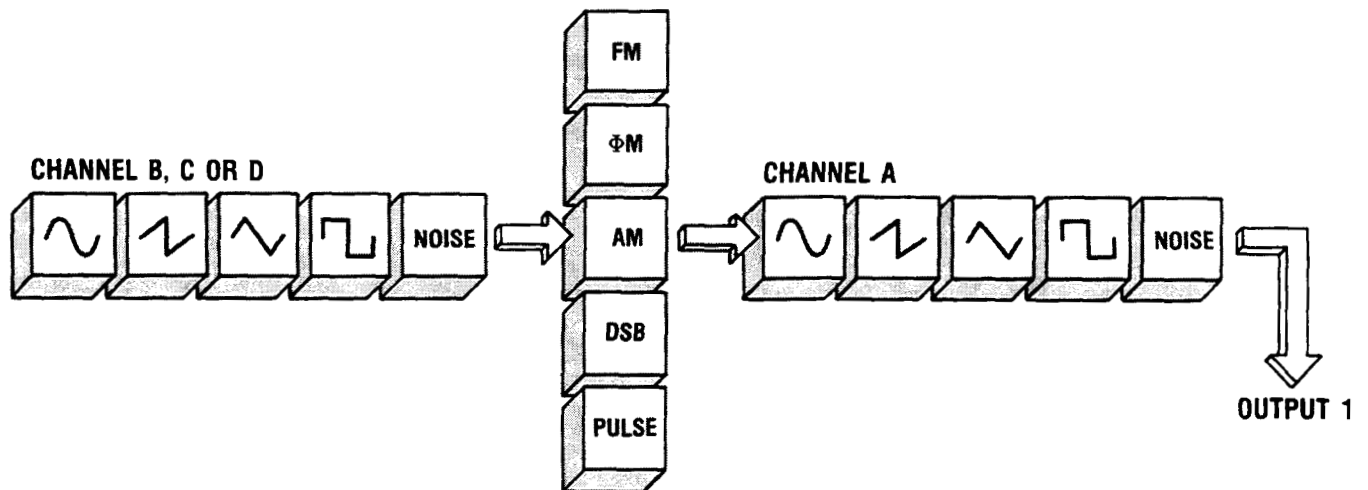

Figure 2-2. The HP 8904A Offers a Wide Selection of Modulation Possibilities.

How to Set Up Simultaneous Modulation

Simultaneous modulation occurs when multiple modulation modes are applied to a single carrier. The HP 8904A makes it easy to simultaneously modulate Channel A using the five modulation modes (AM, FM, Φ M, DSB or Pulse). In the following demonstration, you will configure Channel C to pulse modulate Channel A at the same time that Channel B is amplitude modulating Channel A.

Note

If you have just completed the preceding demonstration, "How to Modulate Channel A," your HP 8904A is correctly configured for beginning this demonstration; proceed to step 1 on the next page.

If your HP 8904A is not configured as shown in Table 2-1, please configure Channels A and B as shown in the table before you begin this demonstration.

Table 2-1. Instrument Settings for Channels A and B.

Channel	Destination	Frequency	Amplitude	Phase	Waveform
A	Out 1	20k	3V	0.0 deg	Sine
B	AM	1000 Hz	90%	0.0 deg	Sine

Add Another Modulation Mode

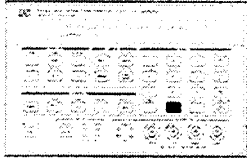

1. Press the NEXT key as needed to access the Channel C Configuration display.
2. Press the blue SHIFT key, the DESTN key and then the PULSE key. You have now configured Channels B and C to simultaneously AM and pulse modulate Channel A.

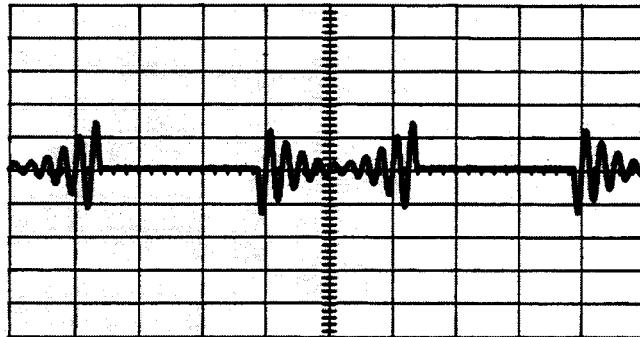

You can simultaneously modulate Channel A with up to three different modulation signals by simply configuring Channel D to also modulate Channel A. Figure 2-3 illustrates the simultaneous modulation possibilities provided by your HP 8904A.

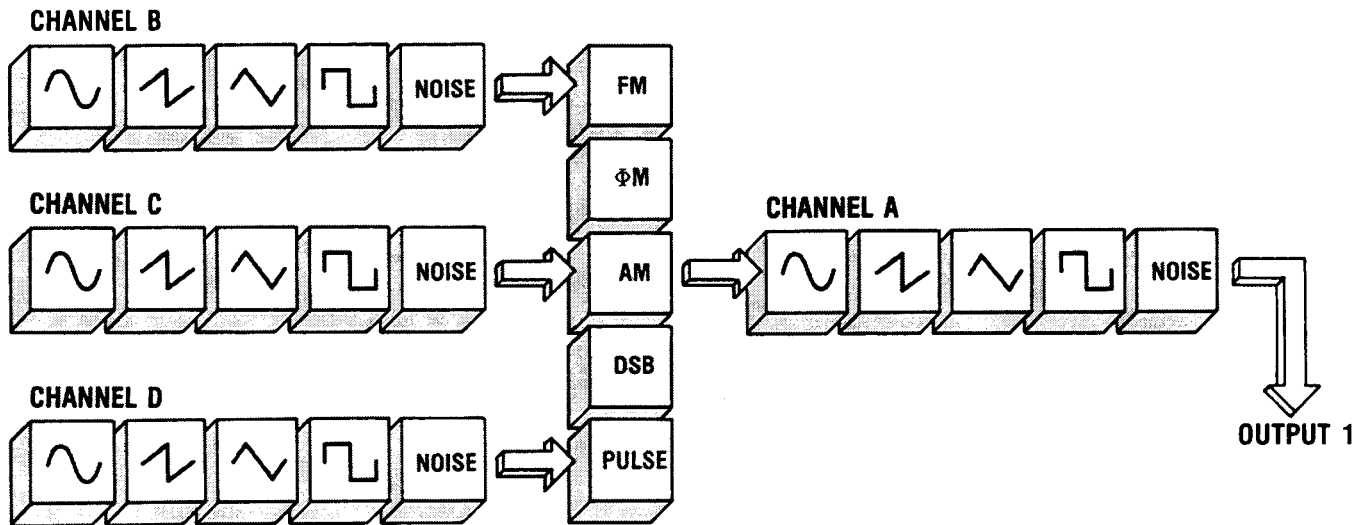
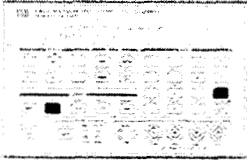

Figure 2-3. The Various Simultaneous Modulation Possibilities.

Now Vary the Phase

With the HP 8904A you can precisely control the phase of each modulation signal.



3. Press the **PHASE** key.
4. Press the **INCR SET** key and enter **45 degrees**. The HP 8904A allows you to advance the phase of the selected channel up to 359.9 degrees.
5. Press the **↑** key. Note on the oscilloscope that the pulse modulation provided by Channel C is advanced 45° each time the **↑** key is pressed.

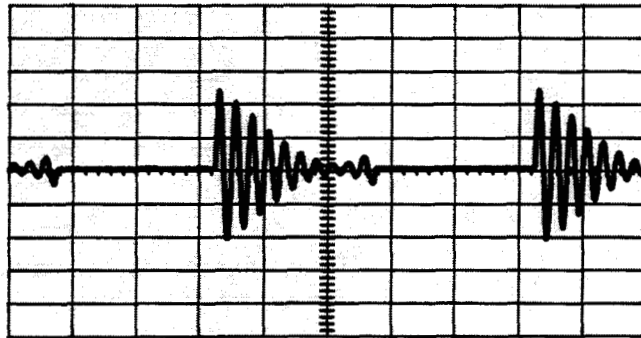

Note

*If you continue to press the **↑** key, you will find that the HP 8904A does not respond to your 45 degree increment at 315 degrees. This is because the maximum phase shift allowed by the HP 8904A is 359.9 degrees ($315 + 45 = 360$).*

How to Sum the Modulation Signals

With the HP 8904A, you can even sum the modulation signals first and then use the resulting signal to modulate Channel A in any one of the HP 8904A's modulation modes. In the following steps, you will sum Channels B and C and use the resulting signal to amplitude modulate Channel A.

Note

If you have just completed the preceding demonstration, "How to Set Up Simultaneous Modulation," your HP 8904A is correctly configured for beginning this demonstration; proceed to step 1 on the next page.

If your HP 8904A is not configured as shown in Table 2-2, please configure Channels A, B and C as shown in the table before you begin this demonstration.

Table 2-2. Instrument Settings for Channels A, B and C.

Channel	Destination	Frequency	Amplitude	Phase	Waveform
A	Out 1	20k	3V	0.0 deg	Sine
B	AM	1000 Hz	90%	0.0 deg	Sine
C	P1se	1000 Hz	N/A	45.0 deg	Sine

Sum Channels B and C

1. Press the blue **SHIFT** key, the **DESTN** key and the **AM** key to configure Channel C to amplitude modulate Channel A.
 2. Press the **AMPTD** key and enter 10%. Channel A is now being 100% amplitude modulated by Channels B (90%) and C (10%).
-

Note

The HP 8904A allows a maximum setting of 100% AM between the combined channels. (For example, with Channel B set at 90% AM, Channel C can only be set at $\leq 10\%$ AM.)

3. Press the **PHASE** key, the **0** key and then the **deg** key to set the phase to 0.0 degrees. (Note that your frequency and phase settings did not change when you changed the modulation mode. Only the amplitude setting changes when you change the destination entry.)

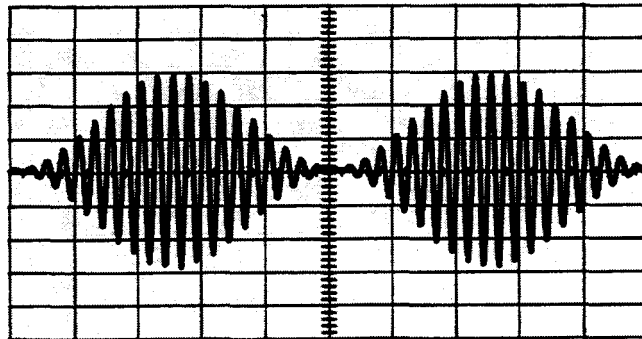

4. Press the **WAVEFORM** key and the **NOISE** key. You have now configured Channel C to add a 10% noise component to the Channel B modulation signal.

Remember

Whenever you select the same modulation modes for two or more channels, these channels are summed and the resulting signal is used to modulate Channel A. Figure 2-4 shows the modulation signal summation capability provided by the HP 8904A.

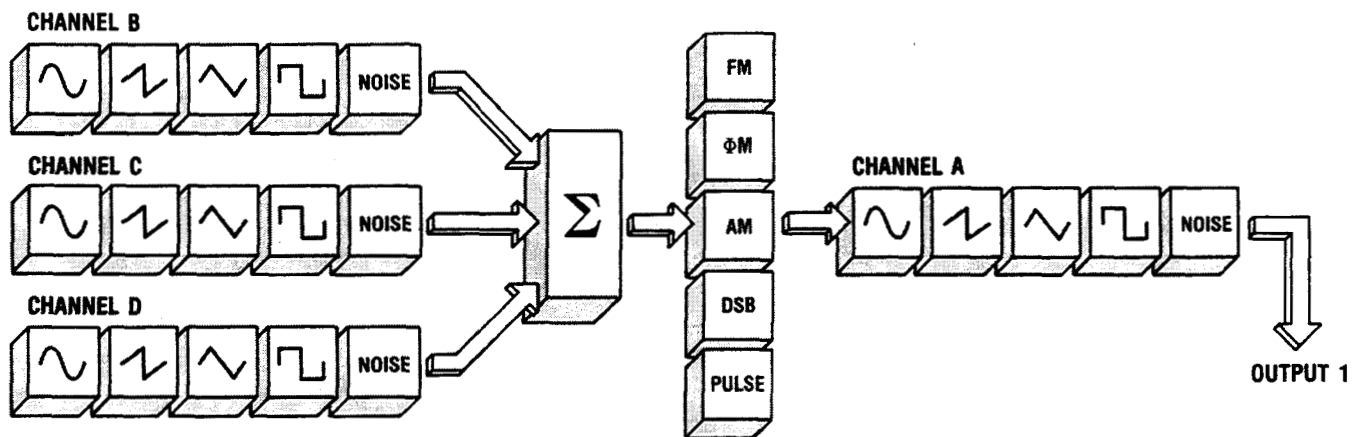

Figure 2-4. The Modulation Signals are first Summed and then used to Modulate Channel A whenever the same Modulation Mode is Selected.

How to Sum the Output Signals

Another possibility offered by the HP 8904A is to sum the output signals. In this demonstration, you will sum the modulated Channel A signal with various other waveforms from Channels C and D.

Note

If you have just completed the preceding demonstration, "How to Sum the Modulation Signals," your HP 8904A is correctly configured for beginning this demonstration; proceed to step 1 on the next page.

If your HP 8904A is not configured as shown in Table 2-3, please configure Channels A, B and C as shown in the table before you begin this demonstration.

Table 2-3. Instrument Settings for Channels A, B and C.

Channel	Destination	Frequency	Amplitude	Phase	Waveform
A	Out 1	20k	3V	0.0 deg	Sine
B	AM	1000 Hz	90%	0.0 deg	Sine
C	AM	N/A	10%	N/A	Noise

Sum Channels A and C

1. Press the blue SHIFT key, the DESTN key and the 1 key. You have configured the Channel C signal to be summed with the modulated Channel A signal.
2. Press the AMPTD key and enter 1V.
3. Press the WAVEFORM key and then the \sim , \wedge , \square and --- keys.

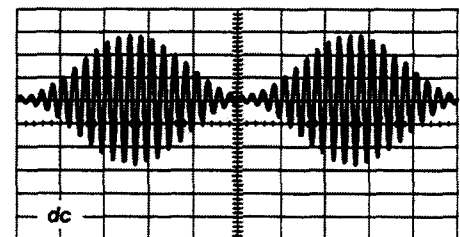
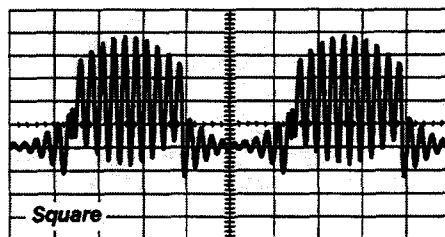
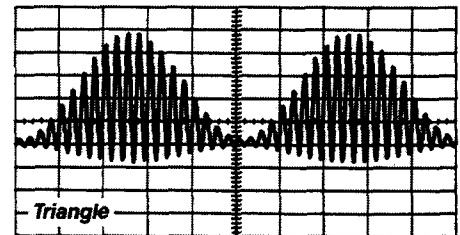
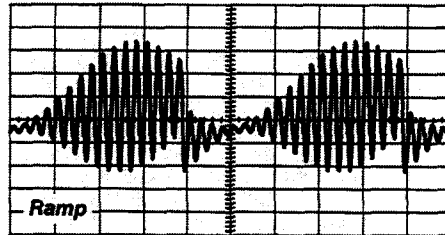

4. Press the \sim key.

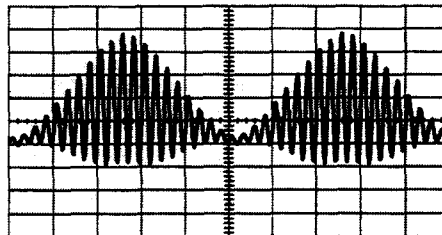

Sum Channel D with A and C

5. Press the NEXT key to access the Channel D Configuration display.
6. Press the blue SHIFT key, the DESTN key and the 1 key.
7. Press the AMPTD key and enter 300 mV.
8. Press the FREQ key and enter 10 kHz. (Adjust the oscilloscope if necessary to get a stable display.)

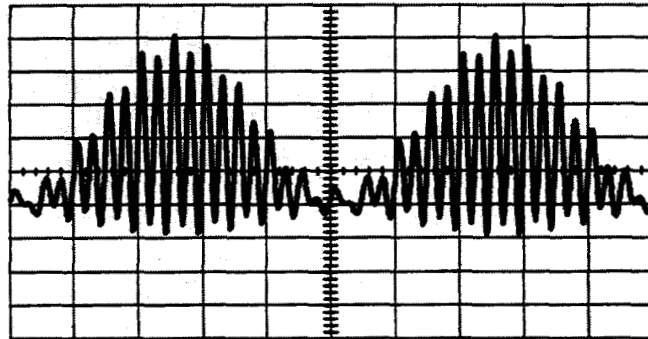

Figure 2-5 shows how channels are summed when you select the same Output Port as the destination for each channel.

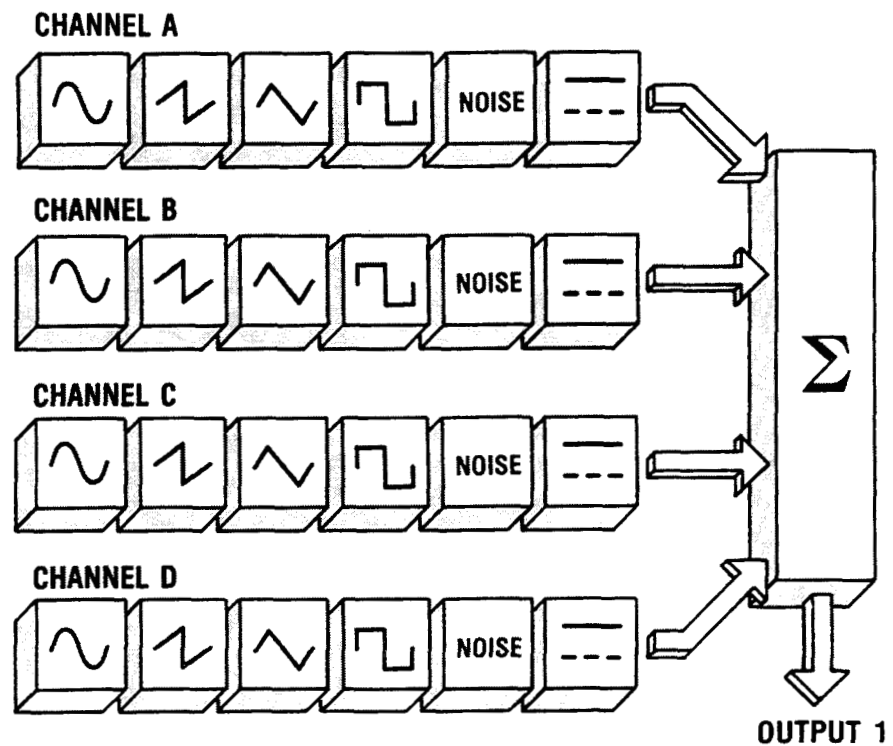

Figure 2-5. The Waveforms from each Channel can be Summed and then Output.

Things to Remember about Four Channel Operation

As you have seen, the HP 8904A's four channels provide you with a wide selection of signal possibilities. Figure 2-6 provides an overview of the HP 8904A's modulation and summation capabilities.

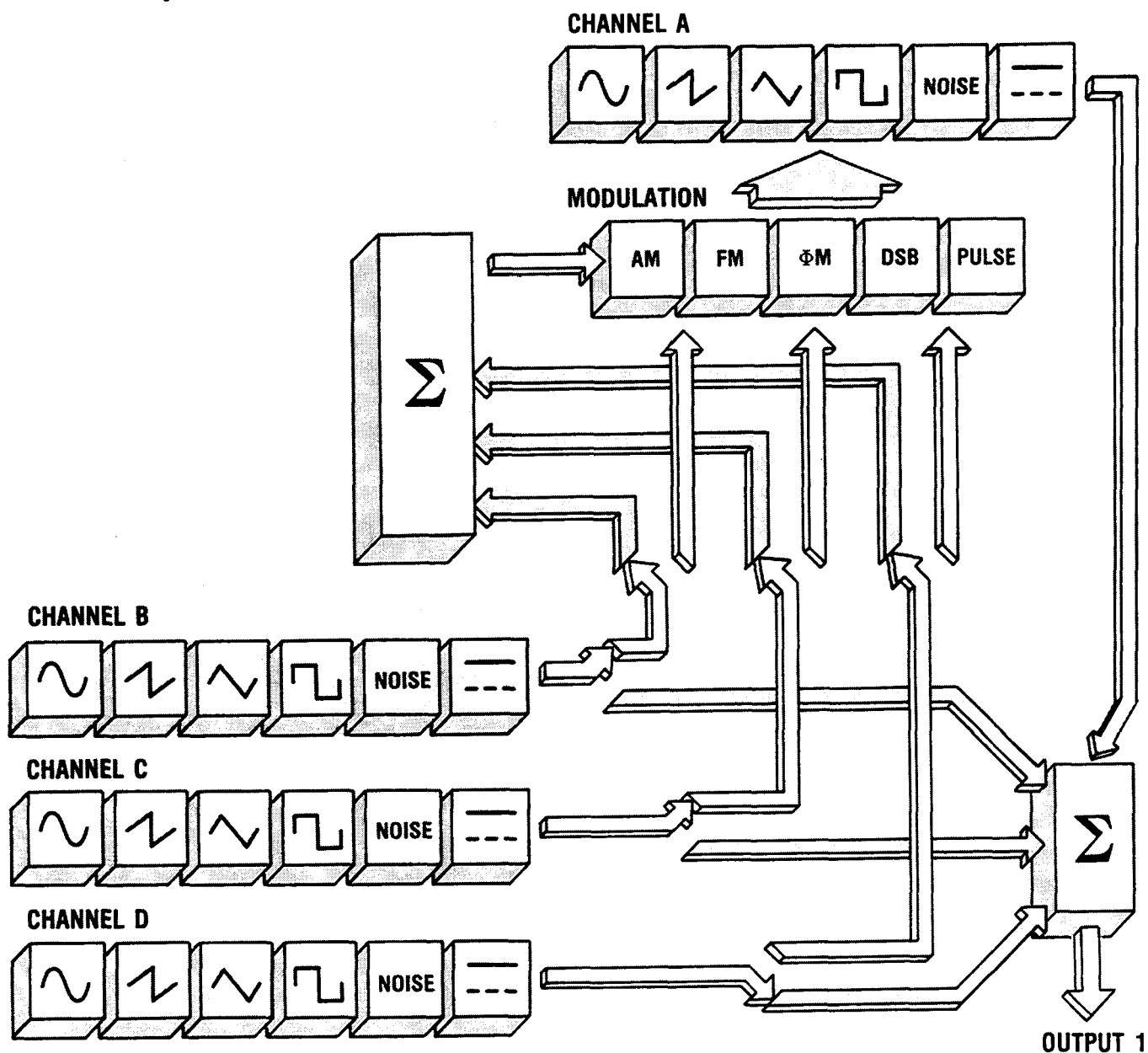

Figure 2-6. The Modulation and Summation Capabilities of the HP 8904A.

Key Points about Operation

Table 2-4 contains operating considerations you should keep in mind as you configure your output signals. Table 2-5 contains the operating ranges for the HP 8904A's modulation capabilities.

Table 2-4. Operating Considerations for Four Channel Operation.

Operation	Considerations
Select Destination	<ul style="list-style-type: none"> • Select the desired destination before setting the amplitude. • Channels B, C and D can be configured as either modulation sources or output signals, but never both.
Modulate Channel A	<ul style="list-style-type: none"> • Only Channel A can be modulated. • Channels B, C and/or D can be used to modulate Channel A. • Displayed modulation levels are peak (the overall deviation is twice the amplitude value shown on the display). • The DSB modulation mode sets Channel A's amplitude setting to the DSB amplitude setting. • When frequency or phase modulation is being used, press the ϕ RESET key after entering the deviation value (AMPTD) to set a zero phase reference for the angle modulation.
Sum Channels	<ul style="list-style-type: none"> • Two, three or four channels may be summed into a single output. • Two or three channels may be summed for modulating Channel A (for example, Destn=AM for Channels B, C and D). • All combinations of channels are acceptable except for combinations that do not allow the HP 8904A to control the four channels (A, B, C and D) in sequence. (For example, you can not AM Channel A with D and sum Channels B and C. Instead simply AM Channel A with B and sum Channels C and D.)
Save Register	<ul style="list-style-type: none"> • Saves the current parameter settings for all four channels.

Table 2-5. HP 8904A Modulation Ranges

Modulation Type	Frequency	Amplitude (Deviation)	Resolution
AM	0.1 Hz to 600 kHz ⁽¹⁾	0.0% to 100%	0.1% of carrier amplitude
FM	0.1 Hz to 600 kHz ⁽¹⁾	0.0 Hz to 600 kHz	0.1 Hz or 3.5 digits (whichever is less)
PM	0.1 Hz to 600 kHz ⁽¹⁾	0.0 deg to 179.9 deg ⁽²⁾	0.1 deg
Pulse	0.1 Hz to 50 kHz	Fixed	N/A
DSB ⁽³⁾	0.1 Hz to 600 kHz ⁽¹⁾	0.0V to 10V	1 μ V

(1) When using a sinewave.
(2) Per channel, with a total of 539.7 degrees possible.
(3) Double-Sideband Suppressed-Carrier AM.

How to Set Up Some Applications

The following application examples show some of the waveforms that you can create using the HP 8904A's Four Channel operating capabilities.

FM Stereo Composite Signal

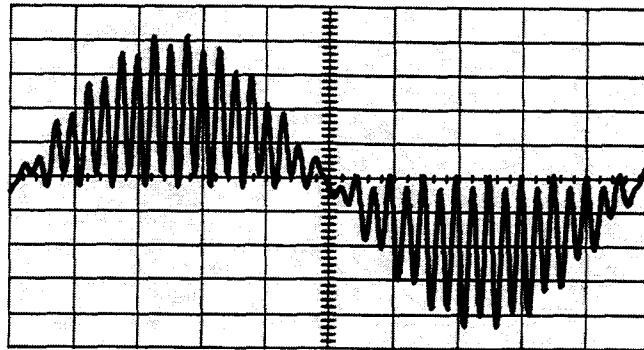

Application:

Testing FM Stereo Receivers

Table 2-6. Instrument Settings for the FM Stereo Composite Signal.

Channel	Destination	Frequency	Amplitude	Phase	Waveform
A	Out 1	38 kHz	140 μ V	0.0 deg	Sine
B	DSB	1 kHz	2.5V	0.0 deg	Sine
C	Out 1	1 kHz	2.5V	0.0 deg	Sine
D	Out 1	19 kHz	0.3V	90.0 deg	Sine

Comments:

1. Adjust the amplitude of Channel D to vary the pilot signal level.
2. DSB is Double-Sideband Suppressed-Carrier AM.

VOR Composite Signal

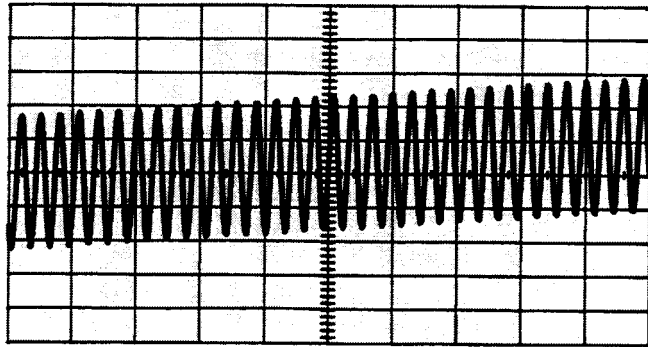

Application:

VOR (VHF Omnidirectional Range) Navigation Radio Testing

Table 2-7. Instrument Settings for the VOR Composite Signal.

Channel	Destination	Frequency	Amplitude	Phase	Waveform
A	Out 1	9960 Hz	2V	0.0 deg	Sine
B	Out 1	30 Hz	2V	0.0 deg	Sine
C	FM	30 Hz	480 Hz	0.0 deg	Sine
D	Off				

Comments:

1. Adjust the phase of Channel C to vary the bearing. (The phase accuracy of the HP 8904A is typically ± 0.05 deg.)

**Variable Duty
Cycle Pulse Train**

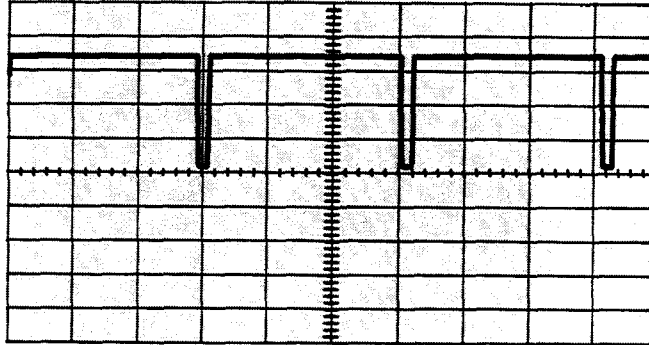

Application:

Where required duty cycle is not 50%

Table 2-8. Instrument Settings for a Variable Duty Cycle Pulse Train Signal.

Channel	Destination	Frequency	Amplitude	Phase	Waveform
A	Out 1	1 kHz	140 μ V	0.0 deg	Square
B	DSB	1 kHz	2.5V	10 deg	Square
C	Out 1	N/A	2.5 V	N/A	dc
D	Off				

Comments:

1. Adjust the phase of Channel B to vary the duty cycle (for example, 90 deg = 50%).
2. Channel C provides a variable dc reference (optional).

Phase Continuous Sweep

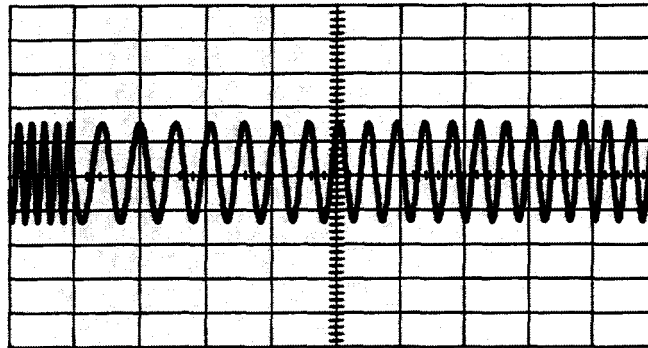

Application:

Frequency Response Testing

Table 2-9. Instrument Settings for a Phase Continuous Sweep Signal.

Channel	Destination	Frequency	Amplitude	Phase	Waveform
A	Out 1	10 kHz	5V	0.0 deg	Sine
B	FM	100 Hz	5 kHz	0.0 deg	Ramp
C	Off				
D	Off				

Comments:

1. Adjust the frequency of Channel B to vary the sweep time (for example, 100 Hz = 10 ms sweep).
2. Adjust the amplitude of Channel B to vary the sweep bandwidth (from 5 kHz to 15 kHz in this example).

3

Output a Sequence of Signals

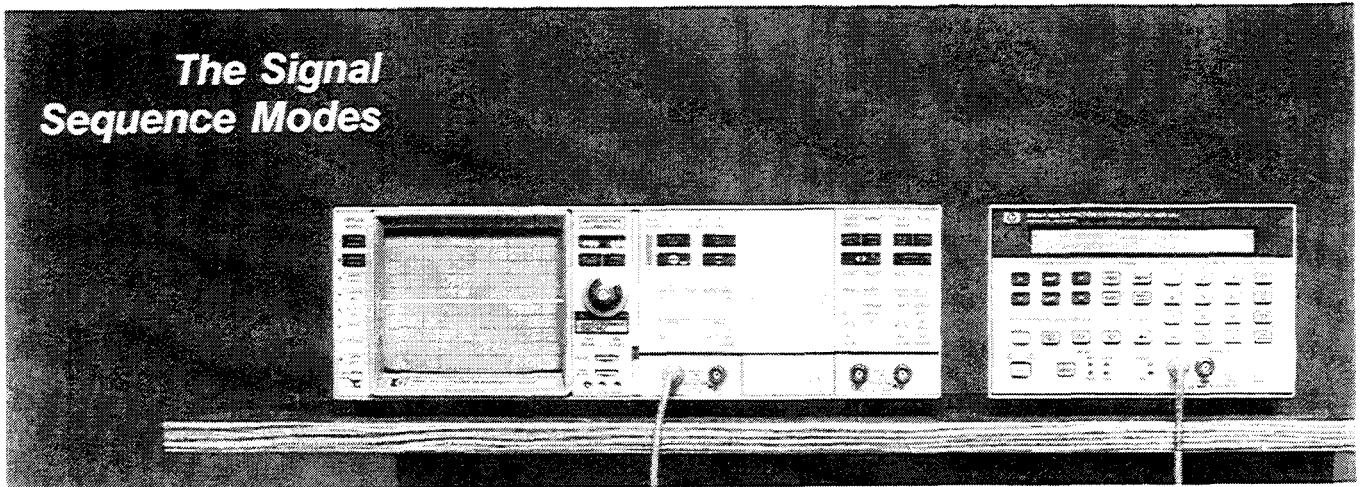

In This Chapter

This chapter contains demonstrations of the Signal Sequencing Modes provided by Configuration Option 01. If your HP 8904A is equipped with Option 01, complete the following demonstrations to learn how to:

- **Output a Tone Sequence**
- **Output a DTMF (Dual-Tone Multi-Frequency) Sequence**
- **Output a Digital Sequence**
- **Set Up a Signal Sequence Application**

Set Up Your Equipment

Connect your HP 8904A to the oscilloscope as shown above.

Adjust Your Oscilloscope

Display Channel A
Volts/Division 2V
Coupling dc (High Impedance)
Time/Division 1.35 ms
Trigger Channel A

Select Chassis Ground

1. Press the blue SHIFT key and then the PRESET key.
2. Press the blue SHIFT key and then the FLOAT key.
3. Press the 1 key and then the OFF key to reference the HP 8904A's circuit ground to chassis ground at Output 1. (Note that the FLOAT LED for Output 1 is now off.)
4. Adjust the oscilloscope's trace position if necessary to center scale.

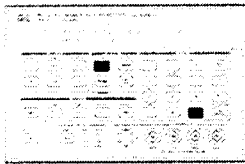

How to Output a Tone Sequence

Tone Sequencing refers to the serial transmission of individual tones in a predetermined order. The HP 8904A's Tone Sequence Mode enables you to configure 16 individual sinewave tones and arrange them in a sequential order that contains up to 250 sequence steps. In this demonstration, you will learn about Tone Sequence operation by configuring a seven-step sequence using four individual tones.

1. Press the **NEXT** key and then the **f1** Tone Sequence softkey to access the Tone Sequence Mode.

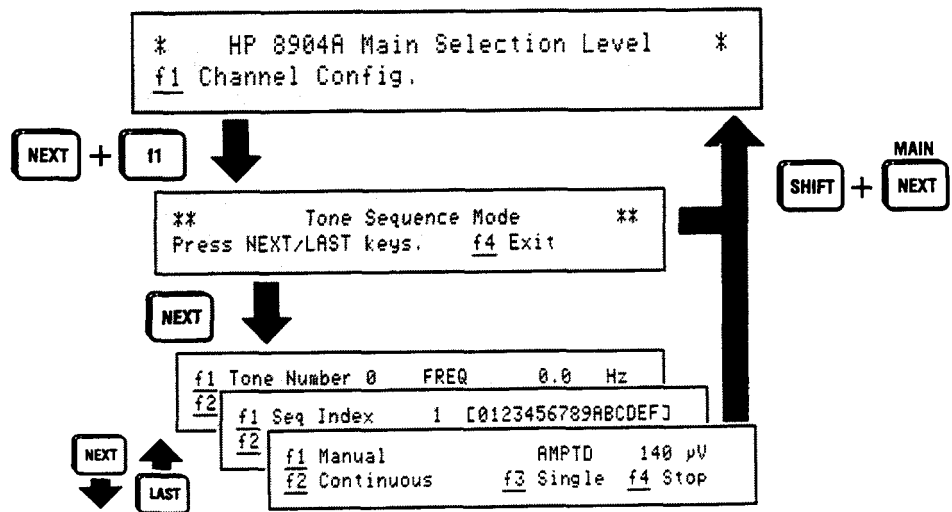

Figure 3-1. How to Access The Tone Sequence Mode.

Enter the Tone Parameters

2. Press the NEXT key to access the Tone Configuration display. This display allows you to specify the characteristics of the tones you wish to have in your sequence. You can configure up to 16 different tones using the HP 8904A's 16 Tone Registers (numbered 0 through F).

```

f1 Tone Number 0      FREQ      0.0  Hz
f2 On Time    1.00ms  f4 Off Time  1.00ms
    
```

Configure Tone Register 0

3. Press the FREQ key and enter 1 kHz.
4. Press the f4 Off Time softkey and enter .8 ms. You have now set Tone 0 to be a 1 kHz signal with a period of 1.8 ms (1 ms on and 0.8 ms off). Note that 1 ms is the default On Time and Off Time setting.

Note

The entered tones will not appear at the output (or on the oscilloscope) until after you have selected a Run Mode as described later in this demonstration.

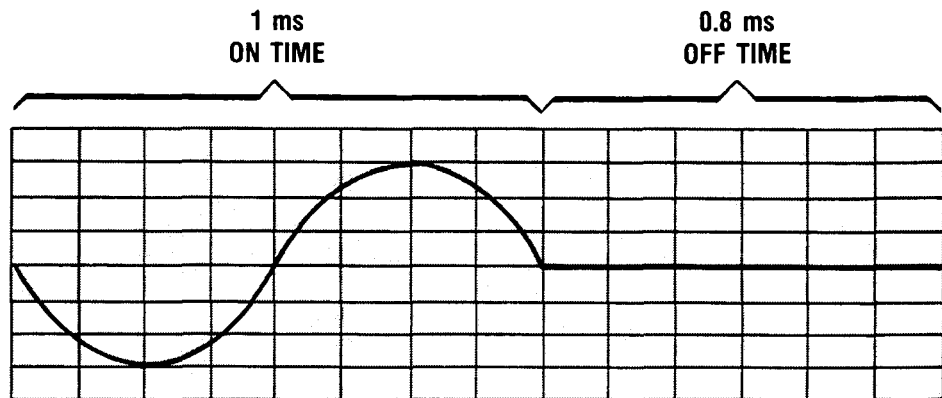

Figure 3-2. Tone 0 Signal

Copy the Off Time

5. Press the blue **SHIFT** key and the **f4 Off Time** softkey. You have copied the displayed Off Time (0.8 ms) to each of the HP 8904A's 15 other Tone Registers. This function is useful when you wish to have the same Off Time for all of your tones. In this demonstration, the tones you configure will all have the same Off Time but will each have a different On Time. (For your own applications, note that the displayed On Time can also be copied by pressing the blue **SHIFT** key and the **f2 On Time** softkey.)

Configure Tone Register 1

6. Press the **f1 Tone Number** softkey and then press **↑** key to access **Tone Register 1**. The Tone Number shown in the display indicates which Tone Register is currently being displayed.
7. Press the **FREQ** key and enter **2 kHz**.
8. Press the **f2 On Time** softkey and enter **1.5 ms**.

Configure Tone Register 2

9. Press the **f1 Tone Number** softkey and then the **2** key. You can access the various Tone Registers by using either the **↑** or **↓** keys or by directly entering the number of the register you desire.
10. Press the **FREQ** key and enter **3 kHz**.
11. Press the **f2 On Time** softkey and enter **2 ms**.

Configure Tone Register 3

12. Press the **f1 Tone Number** softkey and then the **↑** key to access **Tone Register 3**.
13. Press the **FREQ** key and enter **4 kHz**.
14. Press the **f2 On Time** softkey and enter **2.5 ms**.

You have set up four individual tones in Tone Registers 0 through 3. Table 3-1 shows the four tones that you have configured.

Table 3-1. Tone Configuration

Tone Number	Frequency (kHz)	On Time (ms)	Off Time (ms)
0	1.0	1.0	0.8
1	2.0	1.5	0.8
2	3.0	2.0	0.8
3	4.0	2.5	0.8

Specify the Sequence Order

15. Press the NEXT key to access the Sequence String display. This display allows you to define the order in which you wish to output the tones you have setup.

```

f1 Seq Index      1  [0123456789ABCDEF]
f2 Seq End      250  f4 Edit Sequence
    
```

You can arrange your tones in sequence strings that include up to 250 steps. The bracketed field in the upper right corner of the display shows the first 16 tones of the HP 8904A's default sequence string. (The default string is a 250 step sequence that repeatedly cycles through the 16 Tone Registers, 0 through F.)

Step Through the Sequence String

16. Press the f1 Seq Index key and the ↑ key to increment the index value. Notice that the Tone Registers shown within the brackets scroll to the left each time the ↑ key is pressed allowing you to view the rest of the tones in the sequence string. The Seq Index value helps you keep track of where you are as you step through the sequence string by displaying the position number of the first (left most) tone currently shown in the bracketed field. Figure 3-3 illustrates the windowing effect of the bracketed field and the relationship between the sequence string, position numbers and Sequence Index value.

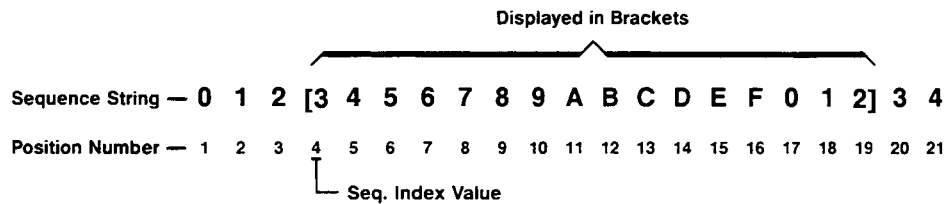
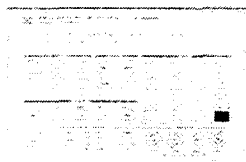

Figure 3-3. Relationship Between the Sequence String, Position Numbers and Seq. Index Value.

17. Hold the \Downarrow key down to return to the first position in the sequence string (Seq Index 1).
18. Press the $\mathbb{14}$ **Edit Sequence** softkey. The Edit function allows you to create the sequence string you desire by deleting and inserting Tone Registers.
19. Press the \uparrow key to position the cursor underneath the **Tone Register 4** entry within the brackets. (Notice that when you are using the Edit function, the Seq Index value increments when you press the \uparrow key to reflect the cursor's current position in the string.)
20. Press the $\mathbb{14}$ **Insert** softkey and enter 2 1 0.
21. Press the $\mathbb{14}$ **Insert** softkey again to turn off Insert, and then press the \Downarrow key once to position the cursor under the 0 Tone Register that you just entered.
22. Press the blue **SHIFT** key and the **END** key. You have now created a seven-step sequence (0123210) using the four tones that you configured.



Select the Run Mode

23. Press the NEXT key to access the Run Mode display.

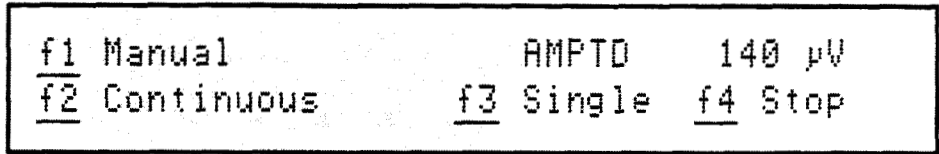

24. Press the AMPTD key and enter 5V. The output amplitude of each tone in your sequence will be 5 Vpk into a high impedance input (or 5 Vpp into a 50Ω input).

25. Press the f1 Manual softkey to access the Manual Step mode.

26. Press the ↑ key to step through the Tone Sequence you have set up. Note that the value shown in brackets in the display is the number of the Tone Register currently being output. The number to the left of the brackets is the sequence position number of that Tone Register.

27. Press the f2 Continuous softkey. This causes the HP 8904A to continuously cycle through your Tone Sequence. (Adjust the oscilloscope triggering, if necessary, to get a stable display.)

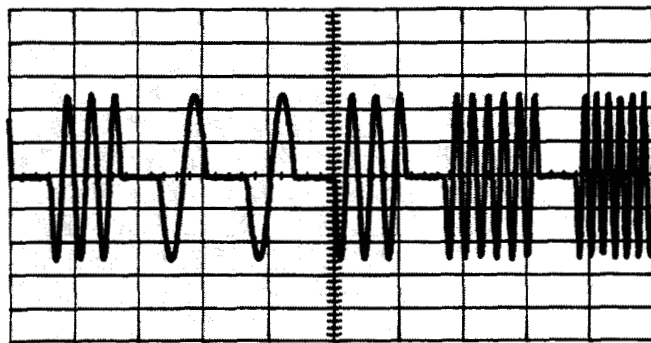

28. Press the f4 Stop softkey and then the f3 Single softkey to output a single pass of the Tone Sequence.

**Save and Recall
Your Sequence**

The HP 8904A will reset the contents of all of its Tone Registers to their default settings when it exits the Tone Sequence Mode to return to the Main Selection Level. When you set up your own signal sequences, you can easily retain all of the parameters you have entered by storing them in a Save Register. When you set up a Save Register (as described in Chapter 1 of this guide), the HP 8904A will store all of the settings for all of its Tone Registers as well as all of its other current operating conditions.

Remember

When you Recall a Save Register, the HP 8904A returns all of its operating modes to the same settings that existed when the Save Register was selected.

This completes the Tone Sequence demonstration. If you wish to try setting up a different sequence order for the signals you have configured, simply press the **LAST** key to return to the Sequence String display and use the Insert and Delete Editing functions to arrange the Tone Registers in whatever order you desire.

How to Output a DTMF Sequence

In this demonstration, you will learn how to configure your HP 8904A to emulate a telephone keypad for outputting DTMF (Dual-Tone Multi-Frequency) signals.

1. If you are not currently at the Main Selection Level display, press the blue SHIFT key and the MAIN key.
2. Press the NEXT key and then the f3 DTMF Sequence softkey to access the DTMF Sequence Mode.

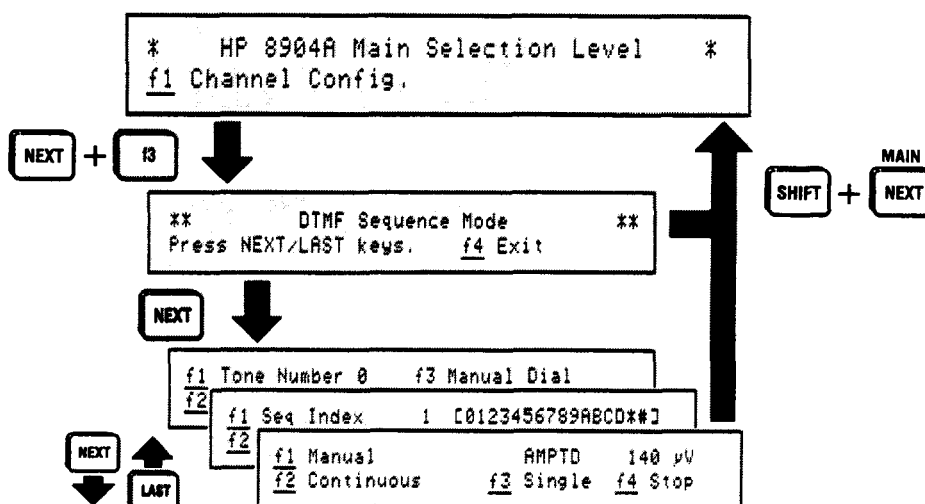
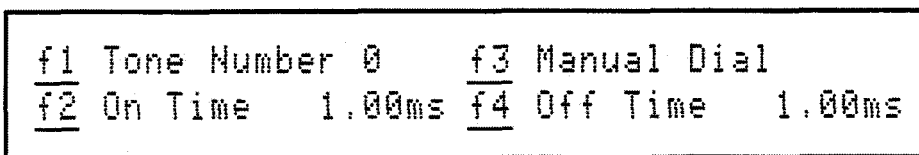

Figure 3-4. How to Access the DTMF Sequence Mode.

Enter the DTMF Parameters

3. Press the NEXT key to access the DTMF Configuration display. This display allows you to define the On Time and Off Time for each DTMF signal.



Configure DTMF Signal 0

4. Press the **f2 On Time** softkey and enter **44 ms**.
5. Press the **f4 Off Time** softkey and enter **44 ms**. You have now defined the period of the 0 DTMF signal to be 88 ms. (Note that the default period for each DTMF signal is 2 ms, 1 ms on and 1 ms off.)

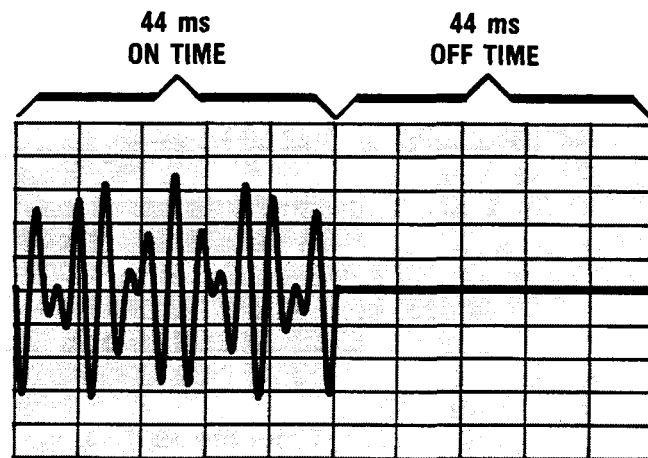
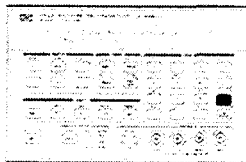

Figure 3-5. 0 DTMF Signal.

Copy the On and Off Times

6. Press the blue **SHIFT** key and then the **f2 On Time** softkey to set the On Time for all of the other DTMF signals to 44 ms as well.
7. Press the blue **SHIFT** key and then the **f4 Off Time** softkey to also set the Off Time for the other DTMF signals to 44 ms.
8. Press the **f1 Tone Number** softkey and then the **C** key. You have accessed the C DTMF signal. (When in the DTMF Sequence Mode, each front-panel DATA key (0 through 9, A through D, and * and #) on the HP 8904A is assigned the appropriate DTMF signal as defined by the Touch-tone® industry standard.) Notice that the On Time and Off Time for the C DTMF signal have each been set to 44 ms.



Specify the Sequence Order

9. Now press the **NEXT** key to access the **Sequence String display**. This display allows you to define the order in which you wish to sequence through the DTMF signals. (Note that the softkeys shown on this display are the same as those described for the Tone Sequence Mode. Refer to *How to Output a Tone Sequence* if you wish to review the operation of these functions.)

```
f1 Seq Index      1 [0123456789ABCD*#]
f2 Seq End       250  f4 Edit Sequence
```

Select the Run Mode

10. Press the **NEXT** key to access the **Run Mode display**.

```
f1 Manual          AMPTD      140 µV
f2 Continuous      f3 Single  f4 Stop
```

11. Press the **AMPTD** key and enter 2V. The output amplitude of each DTMF signal will now be 2 Vpk.
12. Press the **f1 Manual** key and then the **↵** key to step through the DTMF Sequence.

Manual Dial

You can also output the DTMF signals using the HP 8904A's front-panel keys.

13. Press the **LAST** key twice to return to the DTMF Configuration display.

```
f1 Tone Number C      f3 Manual Dial
f2 On Time 44.00ms    f4 Off Time 44.00ms
```

14. Press the **f3 Manual Dial** softkey. You have configured the HP 8904A's front-panel DATA keys to emulate a telephone key pad.
15. Press any one of the DATA keys (0 through 9, A through D, or * or #) to output the corresponding DTMF signal for 44 ms at 2 Vpk. If you wish to hear the DTMF signals, Figure 3-6 shows a connection diagram for connecting an external speaker to Output 1.

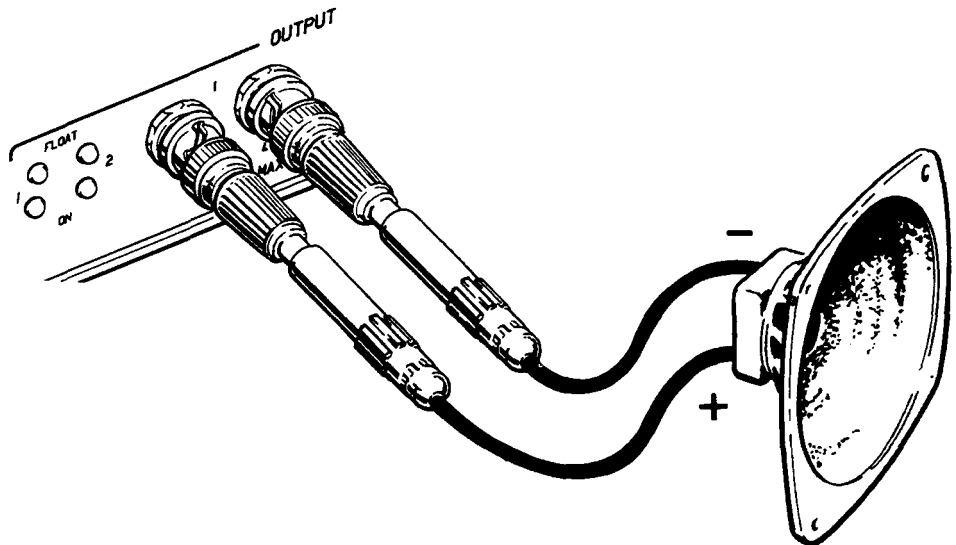

Figure 3-6. Connection Diagram for Connecting an External Speaker to Output 1.

Remember

To use the Manual Dial function, you must first specify an output amplitude in the Run Mode display (as described in this demonstration) in order for the DTMF signals to be $> 140 \mu\text{V}$ at the output.

How to Output a Digital Sequence

In this demonstration, you will output a binary Digital Sequence of TTL compatible bits.

1. If you are not currently at the Main Selection Level display, press the blue **SHIFT** key and the **MAIN** key.
2. Press the **NEXT** key twice and then the **f1** Digital Sequence softkey to access the Digital Sequence Mode.

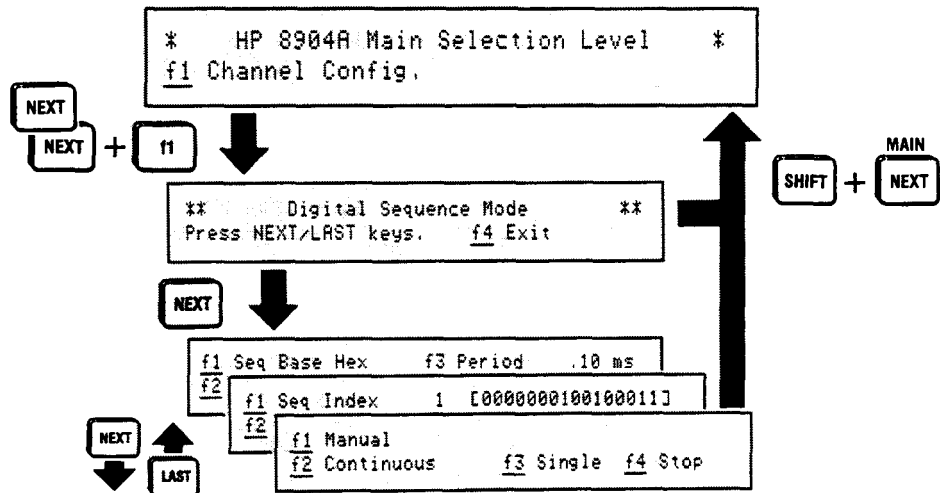
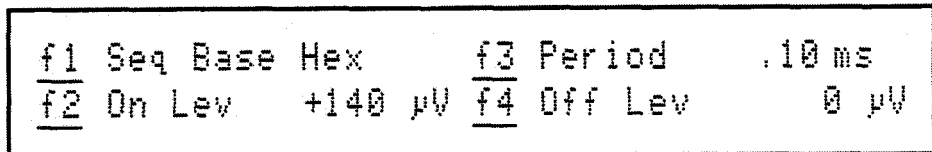

Figure 3-7. How to Access the Digital Sequence Mode.

Enter the Bit Parameters

3. Press the **NEXT** key to access the **Digital Configuration** display. This display allows you to specify the On Level, Off Level and Period for your digital bits.



Note

In this demonstration, we assume active high logic by setting the On Level to correspond to the desired logic level for the 1 bits (+4V) and the Off Level to correspond to the desired logic level for the 0 bits (+0.5V).

You can also configure a Digital Sequence for active low level logic by entering the desired low level as the On Level and the desired high level as the Off Level. Simply keep in mind that the On Level setting always determines the output level for the 1 bits in your sequence string and the Off Level always determines the level for the 0 bits.

Enter the On Level and the Off Level

4. Press the **f2 On Lev** softkey and enter 4V.
5. Press the **f4 Off Lev** softkey and enter 0.5V. Note on the oscilloscope display that the HP 8904A's output signal level is now set to the Off Level that you entered (0.5V).

Enter the Period

6. Press the **f3 Period** softkey and enter 1 ms. The period of each 1 Bit and each 0 Bit in your sequence will now be 1 ms.

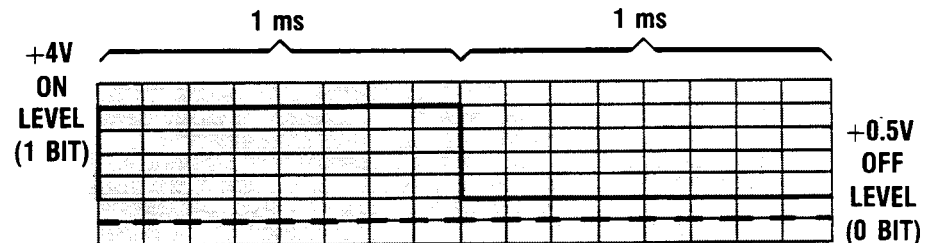

Figure 3-8. 1 and 0 Bit Characteristics.

Select the Base You Desire

7. Press the **f1 Seq Base** softkey twice so that **B** in appears in the display. The HP 8904A allows you to select between a Hexadecimal, Binary or Octal base numbering system for formatting your Digital Sequence.

Things to Remember About the Signal Sequence Modes

You have now completed the setup procedures for each of the three Signal Sequence Modes: Tone, DTMF and Digital. The following outline lists the key steps for setting up a signal sequence. Figure 3-9 illustrates the HP 8904A's Signal Sequencing capabilities.

1. *Enter the parameters* for each signal you wish to include in your sequence.
2. *Specify the order* in which you wish for the signals to be output.
3. *Select the method* you desire for outputting the sequence (Manual Step, Single Sequence or Continuous Cycle).

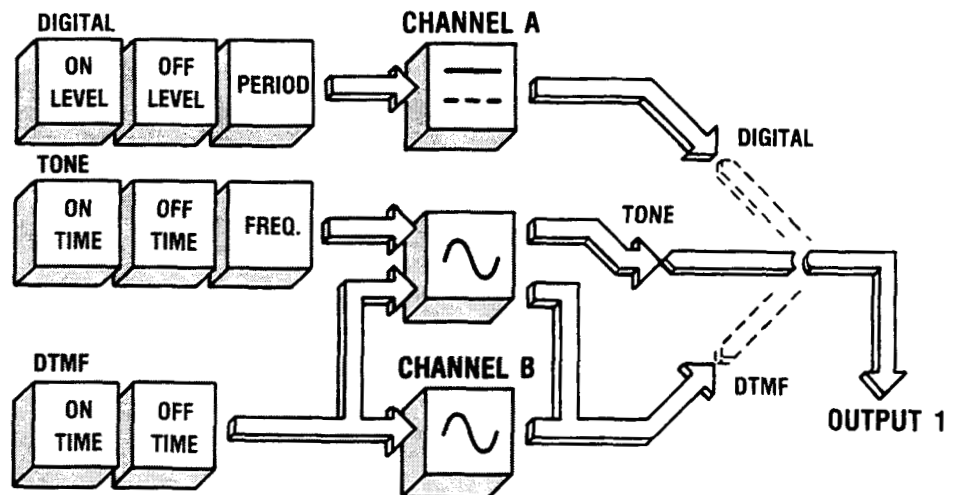

Figure 3-9. The HP 8904A's Signal Sequence Capabilities.

**Key Points
About Operation**

Table 3-2 contains a few operating considerations you should keep in mind as you configure your signal sequences. Table 3-3 contains the specified operating ranges for each the Signal Sequence Modes.

Table 3-2. Operating Considerations for Signal Sequencing.

Operation	Considerations
Copy Parameters	<ul style="list-style-type: none"> Press the blue SHIFT key and then f2 On Time or f4 Off Time softkeys to copy the displayed time for every tone or DTMF signal.
Output Signal	<ul style="list-style-type: none"> The specified Tones or DTMF signals will not appear at the output (> 140 μV) until an amplitude setting has been entered. The Signal Sequence Modes can only be output at Output Port 1.

Table 3-3. Signal Sequence Specifications.

Specifications				
Sequence Mode	Number of Frequencies	On Time ⁽¹⁾	Off Time ⁽¹⁾	Sequence Length
Tone	16	0.80 ms to 655.35 ms	0.80 ms to 655.35 ms	1 to 250 Tones
DTMF	16	1.0 ms to 655.35 ms	1.0 ms to 655.35 ms	1 to 250 DTMF signals
Sequence Mode	On Level	Off Level	Period	Sequence Length
Digital	-10V to +10V	-10V to +10V	0.1 ms to 655.35 ms	1 to 1000 Bits

⁽¹⁾ Note that either the On Time or the Off Time can be set to 0, but not both.

How to Set Up an Application

Phase Continuous Stepped Sweep

The following setup example demonstrates a Tone Sequence that can be created using an HP 8904A.

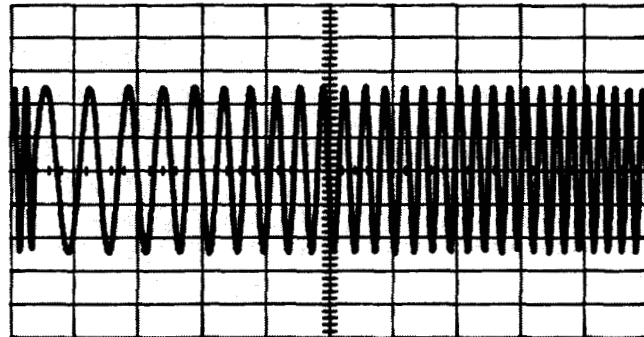

Application:

Phase continuous stepped sweeping from 100 Hz to 10 kHz.

Table 3-4. Instrument Settings for Phase Continuous Sweep.

Tone Number	Frequency (kHz)	On Time (ms)	Off Time (ms)
0	100	2.0	0.0
1	200	2.0	0.0
2	300	2.0	0.0
3	500	2.0	0.0
4	700	2.0	0.0
5	900	2.0	0.0
6	1k	2.0	0.0
7	2k	2.0	0.0
8	3k	2.0	0.0
9	4k	2.0	0.0
A	5k	2.0	0.0
B	6k	2.0	0.0
C	7k	2.0	0.0
D	8k	2.0	0.0
E	9k	2.0	0.0
F	10k	2.0	0.0

Comments:

1. The Tone Sequence is: 0 1 2 3 4 5 6 7 8 9 A B C D E F
2. The Run Mode can be: Single or Continuous (5V)

Multi-Instrument Phase Synchronization

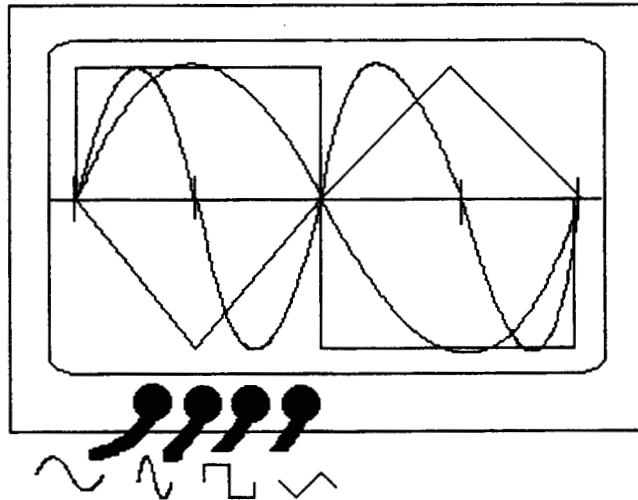

Introduction

This document is a supplement to the *HP 8904A Multifunction Synthesizer Basic Operation and Application* guide and the *Operation and Calibration Manual*. It contains operation and reference information specific to HP 8904As with Option 005 installed. This information includes the following:

- A *General Description* of the added capabilities available with this option.
- A description of the *Electrical Connections* unique to Option 005-equipped instruments.
- Step-by-step *Detailed Operating Instructions* that explain instrument connections and settings for phase synchronizing two or more HP 8904As.
- A list of *HP-IB Operation* codes specific to Option 005-equipped HP 8904As, and a programming example.
- A complete list of *Specifications*.

General Description

The HP 8904A Option 005 allows the phase synchronization of two or more HP 8904As equipped with Option 005. Phase synchronization is accomplished by interconnecting the phase-setting signals of each instrument's digital waveform synthesis circuitry in a "Master/Slave" relationship. One instrument provides phase reset and clock synchronization signals for the other instruments. These signals provide a common phase reference point for up to 16 separately configured channels (using eight instruments equipped with options 002 and 005).

When SYNCHRONOUS MODE has been enabled, the Phase Reset and SYNC Clock signals are re-routed to the connectors at the rear of the instrument. If an instrument is being used as the Master controller, these signals must be routed back into the instrument to function properly. These signals are also connected to any Slave instruments for phase synchronization.

Electrical Connections

Four female BNC connectors are used to interconnect the instruments for phase synchronization:

SYNC CLOCK - OUTPUT

This connection provides an output for the internal clock signal used for latching internal waveform and amplitude data into the analog-to-digital converters. It provides the Master synchronizing signal for connecting two or more HP 8904As for phase synchronization. This signal is not used when the instrument is configured as a Slave.

SYNC CLOCK - INPUT

The SYNC CLOCK OUTPUT signal is input here to provide the clock signal for latching the waveform and amplitude data into the analog-to-digital converters. If the instrument is configured as the Master controller, its own SYNC CLOCK OUTPUT signal must be routed back to this connector for the instrument to function properly.

Φ RESET - OUTPUT

This connection provides an output for the internal phase reset signal. This signal establishes a common phase starting point for the output signals. It provides the Master phase reset signal for connecting two or more HP 8904As for phase synchronization. This signal is not used when the instrument is configured as a Slave.

Φ RESET - INPUT

The Φ RESET OUTPUT signal is input here to provide the phase reset signal that establishes a new phase starting point for the output signals. If the instrument is configured as the Master controller, its own Φ RESET OUTPUT signal must be routed back to this connector for the instrument to function properly.

Detailed Operating Instructions

Cable Connections

Power Splitters – Low loss power splitters must be used to provide the necessary impedance match and signal distribution to each instrument. Terminate any unused power splitter outputs with a 50Ω load. Recommended power splitters are listed in the specifications at the end of this supplement.

Cable Length – Since phase delay is directly proportional to conductor length, the length of all cables should be the same when they share a common signal from the Master controller. Cable length from the Master controller to the power splitters is not critical; cable length from the splitters to the instruments is critical.

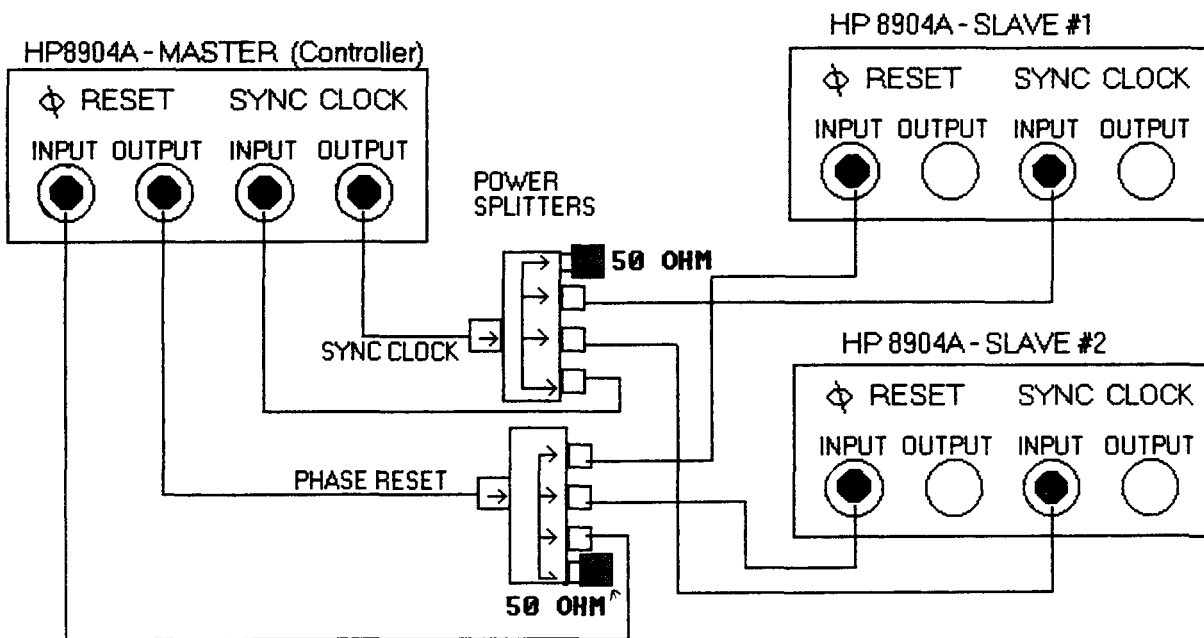

Figure 3A-1. Connecting Cables and Power Splitters for Phase Synchronization.

Accessing the Required Menu Settings

Two instrument settings are required to phase synchronize multiple HP 8904As; both settings are in the the *Special* menu. These are the specials:

1. Special #6 - Enable Synchronous Mode, and
2. Special #7 - Configure As MASTER Controller.

Enable Synchronous Mode - allows you to enable or disable the Option 005 capabilities. Configure as MASTER Controller - defines whether the instrument will be a Master or Slave when using Option 005 capabilities. (Only one instrument may be configured to be the Master controller.)

To access these specials from the Main Selection Level menu, press these keys: **SHIFT, SPECIAL, 6, ENTER**. (Press **NEXT** to access Special #7.) The following figure illustrates these steps.

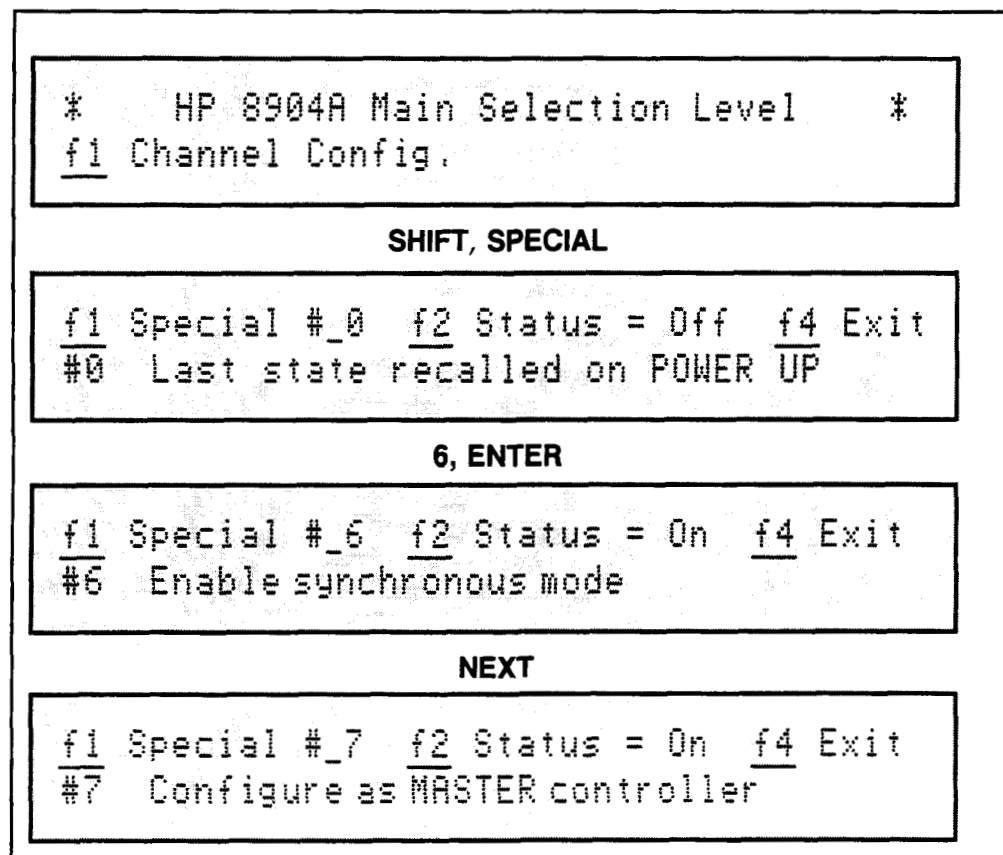

Figure 3A-2. Accessing the Phase Synchronization Special Functions

All instruments that are to be phase synchronized must have Special Function # 6 enabled by pressing **f2, ON**.

Only one of the instruments may be set to be the Master controller. Use the same key sequence (**f2, ON**) to enable this function.

Press **f4** to return to the Main Selection Level menu.

You can now make whatever signal and output settings you need on each of the connected instruments. Once all instrument settings have been made, press the **SHIFT, Φ RESET** keys on the Master controller to synchronize all of the connected instruments.

Whenever the frequency or destination of any channel on a Slave instrument is changed, or if it is turned off and on, a **Φ RESET** must be performed by the Master controller to re-synchronize all channels.

An Example of Phase Synchronization

The following operation example uses three HP 8904As equipped with Option 005. It utilizes one output per instrument to provide three separate phase-synchronized signals. If you are not familiar with the Channel Configuration operations needed to output a signal, refer to the *HP 8904A Multifunction Synthesizer Basic Operation and Application* guide for detailed operating instructions.

- 1) Connect the necessary power splitters and cables (use figure 3-1 as a guide).
- 2) Turn all the instruments on and enable special function #6 - Enable synchronous mode. (This is required for the Master controller and all Slave instruments.)
- 3) To set up the Master controller, enable special function #7 - Configure as MASTER controller.
- 4) Return all instruments back to the Main Selection Level menu.
- 5) Access the Channel Configuration Mode for all instruments and make the following Channel A settings:
 - **FREQ** 1000.0 Hz
 - **AMPTD** 1.000 V
 - **PHASE** 0.0 deg
 - **DSTN** Out1
 - **WFORM** settings: Master controller = Sine \sim ; Slave #1 = Sq \sqcap ; Slave #2 = Trngl \sim .

- 6) Connect the OUTPUTS-1-HIGH signal from each instrument to the inputs of a multi-channel oscilloscope. Set the oscilloscope to trigger on the signal from the Master controller. Set the time/division at 0.1 ms.
- 7) Center each waveform on the oscilloscope's display so that the tops and bottoms of each waveform are at the same level.
- 8) Using the SAVE/RECALL function, SAVE the instrument settings for both of the Slave instruments, and then turn the power off.
- 9) Turn both Slave instruments back on and recall the saved settings. At this point, the zero-crossings of the three signals should not align.
- 10) Press **SHIFT**, Φ **RESET** on the Master controller. The zero-crossings of all three signals should align as shown in the illustration below.

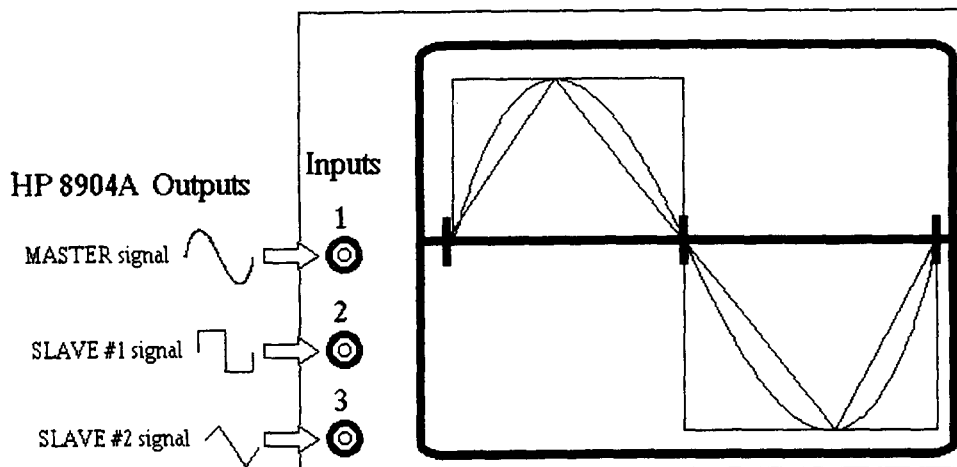

If the zero-crossings of the signals are not aligned, verify that you have properly enabled special functions 6 and 7. Also, check for the proper Master/Slave instrument connections.

HP-IB Operation

Remote Control Commands for Option 005

Two new Special Function HP-IB codes are used with Option 005-HP 8904As. The binary-weighted codes are entered as an ASCII equivalent to enable, disable, or read the status of the phase synchronization special functions.

For more information on how special functions are programmed, refer to table 3-4, *HP-IB Codes for the Standard HP 8904A Functions (4 of 5)*.

Special Flag Bit Assignments:

Special Function	Operation	Bit Pattern
6	Enable synchronous mode	XXXX XXXX X1XX XXXX
7	Configure as MASTER controller	XXXX XXXX 1XXX XXXX

Using these bit patterns, the ASCII value for special function 6 is 64. The ASCII value of special function 7 is 128.

Programming Considerations

Always interconnect the instruments prior to enabling these special functions. An error message is displayed if the proper clock and synchronization signals are not present when these special functions are enabled.

Every time the Set Function (SF) command is used to set the special functions, the previous special function settings are removed. When setting multiple special functions, add the values for all the functions to arrive at the proper ASCII number. For instance; if you are setting specials 6 and 7 for an instrument, add their values together (64 + 128) to arrive at the proper special function setting value (192). (This setup is used in the following programming example.)

Remote Programming Example

```

10      ! HP 8904A Option 005 remote operation example.
20      ! This program sets the special functions and then
30      ! reads the special function status to verify they
40      ! have been set. It then configures channel A of each
50      ! instrument. The two signals are then phased synchronized

60      OUTPUT 726;"PS"           ! Preset HP 8904A #1 (MASTER controller)
70      OUTPUT 725;"PS"           ! Preset HP 8904A #2 (Slave)
80      OUTPUT 726;"SF192"        ! Enable synchronous mode and enable this
90      ! instrument as the MASTER controller. (ASCII equiv. bit 7&8)
100     OUTPUT 725;"SF64"         ! Enable synchronous mode only. (ASCII equiv. bit 7)
110     OUTPUT 726;"RSF"          ! Read special function settings from HP 8904A #1.
120     ENTER 726;A$
130     PRINT "Master controller special functions =",A$
140     OUTPUT 725;"RSF"          ! Read special function setting from HP 8904A #2.
150     ENTER 725;B$
160     PRINT "Slave instrument special functions = ",B$
170     OUTPUT 726;"GM0,FRA1KZ,APA1VL,WFASI" ! Set MASTER CHAN A - 1 Volt Sine Wave
180     OUTPUT 725;"GM0,FRA1KHZ,APA1VL,WFASI" ! Set Slave CHAN A - 1 Volt Sine Wave
190     OUTPUT 726;"PR"           ! Phase reset the MASTER Controller to phase synchronize
200     ! both instruments.

```

Specifications

Unit-to-Unit Phase Accuracy: Additional 30 ns error, 0.1 Hz to 100 kHz. (Total phase error between units is then the greater of 0.1 deg or 60 ns. 0.1 Hz to 100 kHz.)

Maximum Number of Synchronized Units: Eight (8) units using low-loss power splitters (for a total of 16 phase related channels if all units have options 002 and 005).

Recommended Power Splitters:

≤ 4 units synchronized: Mini-Circuits™ ZSC-4-3 or equivalent.
 ≤ 8 units synchronized: Mini-Circuits™ ZFSC-8-1 or equivalent.

3B

HP 8904A Option 006

High Power Balanced Output

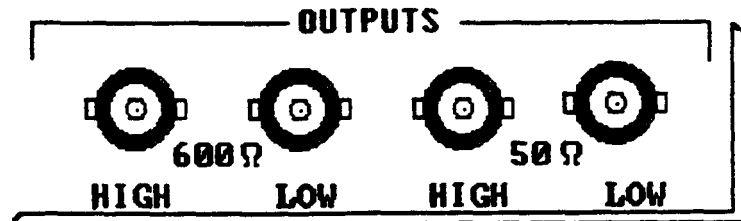

Introduction

This document is a supplement to the *HP 8904A Multifunction Synthesizer Basic Operation and Application* guide and the *Operation and Calibration Manual*. It contains operation and reference information specific to HP 8904As with Option 006 installed.

General Description

The HP 8904A Option 006 replaces the standard 50Ω output of Output 1 with a true transformer-coupled 600Ω output. This 600Ω full-floating output provides higher power than the standard 50Ω output, and can be configured as either single-ended or balanced. This capability is only available for Output 1.

Option 006 can not be installed in combination with Option 004 - Rear Panel Outputs. A second output can be installed to provide a 50Ω output by ordering Option 002.

Operating Considerations

The amplitude displayed on the instrument's front panel assumes an external load of 600Ω. Connecting a high impedance load results in an amplitude of up to twice that indicated for Output 1.

The Option 006 output is specified for sinewaves only, and for the frequency range of 30 Hz to 100 kHz. Output frequencies up to 200 kHz are available if the typical -4dB rolloff characteristic of the transformer is acceptable.

Due to the nature of a transformer coupled output, the Option 006 output can not pass DC or low frequency signals. This characteristic prevents Option 006 from outputting digital sequences provided with Option 001.

Refer to the accompanying specifications for additional operating parameters.

**HP 8904A Option
006 Specifications**

All specifications for the standard 50 Ω output are degraded by the accuracy, flatness, and distortion specifications of the 600 Ω transformer coupled output.

Output Type: Fully floating/balanced transformer-coupled.

Usable Output Frequency Range: 30 Hz to 200 kHz.

AC Amplitude (Sine Wave Only):

Range

Open circuit - 0 to 20 V rms

600 Ω load - 0 to 10 V rms

150 Ω load - 0 to 4 V rms

50 Ω load - 0 to 1.5 V rms

Resolution

3 $\frac{1}{2}$ digits

Accuracy (amplitude >40 mV rms into a 600 Ω load).

6% (0.5 dB) 30 Hz to 20 kHz

12% (1.0 dB) 30 Hz to 100 kHz

Flatness (amplitude >40 mV rms into a 600 Ω load).

+ 0.15 dB, - 0.15 dB, 30 Hz to 20 kHz

+ 0.15 dB, - 0.75 dB, 30 Hz to 100 kHz

Spectral Purity (Sine Wave Only):

THD + N (including spurs; amplitude 140 mV rms to 10 V rms into a 600 Ω load):

- 46 dB (0.5%), 30 Hz to 300 Hz, 30 kHz BW,
amplitude <1 V rms into a 600 Ω load.

- 60 dBc (0.10%), 300 Hz to 7.5 kHz, 30 kHz BW

- 63 dBc (0.07%), 7.5 kHz to 20 kHz, 80 kHz BW

- 55 dBc (0.18%), 20 kHz to 100 kHz, 750 kHz BW

Supplemental Characteristics:

Balance: Typically >40 dB, 30 Hz to 50 kHz

Flatness: (Amplitude >40 mV rms into a balanced 600 Ω load)
Typically +0.2, -4 dB, 30Hz to 200 kHz

Output Impedance: Nominally 600 Ω

THD + N (including spurs; amplitude 140 mV rms to 1 V rms into a balanced 600 Ω load):

Typically -50 dB (0.32%), 30 Hz to 300 Hz, 30 kHz BW.

3C

HP 8904A Option 001 Enhancements

Expanded Capabilities for Option 001

This document is a supplement to the *HP 8904A Multifunction Synthesizer Basic Operation and Application* guide and the *Operation and Calibration Manual*. It contains operation and reference information specific to HP 8904As with Option 001, and with serial prefix 2948A or above.

The HP 8904A Option 001 capabilities have been expanded to include two new operating modes; Hop RAM Sequencing and FM Stereo. These functions are described in detail in separate sections of this supplement. The information provided includes the following topics:

- General Description
- Detailed Operation
- HP-IB Operation

Hop RAM Sequencing

```
##          Hop RAM Sequence Mode          ##  
Press NEXT/LAST keys.      f4 Exit
```

General Description

Hop RAM Sequence mode is a combination of the Digital Sequence mode of Option 001 and the Hop RAM mode of Option 003. Unlike the Option 003 Hop RAM function that requires an external timing signal, Hop RAM Sequence mode uses an adjustable internal timing signal.

Detailed Operation

To enable the Hop RAM Sequence mode from the Main Selection Level, press the **NEXT** key until **f3 HOP RAM Sequence** is displayed. Press the **f3** key to access the first level Hop RAM menu. Use the **NEXT** and **LAST** keys to access the other Hop RAM menus.

You can return the instrument to the Main Selection Level at any time by pressing the **SHIFT, MAIN** keys.

Defining the Hop RAM Address Settings

```

f1 Hop Ram Adrs 0  FREQ      0.0 Hz
AMPTD      0  $\mu$ V      PHASE      0.0 Deg

```

f1 Hop RAM Address - Hop RAM addresses are used to store frequency, phase, and amplitude settings. These settings can then be arranged as a sequence to create the desired signal. To select a Hop RAM address, press the f1 key and then enter the desired address number. The $\uparrow\downarrow$ keys can also be used to select the Hop RAM address after the f1 key is pressed.

Frequency, Phase, and Amplitude Settings - These parameters are entered by pressing the associated **SIGNAL** key and entering the numeric value and terminator.

Specifying the Output and Editing Formats

```

f1 Seq Edit Base Hex f3 Burst Length 1
f2 Seq Output Base Hex  WFORM Sine

```

f1 Seq Edit Base - The sequence edit base determines the number system (hexadecimal, octal, or binary) used when displaying and editing the sequence. Press f1 to select the edit function, and then press it again to alter the edit base.

f2 Seq Output Base - The sequence output base determines how the sequence data will be interpreted. The two number systems available are hexadecimal and binary.

In the hexadecimal mode, each number in the sequence corresponds to one of the 16 Hop RAM addresses. All 16 addresses of the Hop RAM can be used, limiting the maximum sequence length to 750 four-bit characters.

In the binary mode, each bit in the sequence is interpreted as a binary number that corresponds to either address 0 or 1 of the Hop RAM. Only two signal states can be used in this mode, but the maximum sequence length is increased to 3000 bits.

f3 Burst Length - The burst length specifies the number of times the sequence will be repeated if the burst mode is used. The minimum number is one (similar to the Single mode of the other sequence modes); the maximum number is 127.

WFORM - This function allows you to select any one of the six standard waveforms to be output. Since this setting defines the waveform for all Hop RAM addresses, the waveform type can not be hopped.

Sequence Editing

<u>f1</u> Seq Index	1	[0123456789ABCDEF]
<u>f2</u> Seq End	750	<u>f4</u> Edit Sequence

f1 Seq Index - The sequence index indicates where a sequence entry is relative to the entire sequence. You can use this function to jump to any place in the sequence for editing purposes.

In the menu above, the sequence index is 1. This indicates that the number 0 is the first number in the sequence. If the number 15 was entered for the sequence index, the displayed sequence would change so that the 15th character in the sequence (E hex) would be at the far left of the displayed sequence.

f2 Seq End - The sequence end defines the number of Hop RAM addresses in the sequence.

f4 Edit Sequence - Pressing **f4** enables functions that allow you to insert or delete sequence entries.

Output Control

```
f1 Manual          Seq FREQ 1000 Hz
f2 Continuous      f3 Burst  f4 Stop
```

f1 Manual - The manual function allows the user to step through the sequence using the ↑ ↓ keys.

f2 Continuous - Continuous mode causes a sequence to be repeated until it is either disabled using the **f4 Stop** key, or stopped by exiting the Hop RAM Sequence menu.

f3 Burst - The burst function causes a sequence to be output from 1 to 127 times; depending on the burst length setting. (The default is 1.)

f4 Stop - This stops the current sequence during its execution.

Seq FREQ - The sequence frequency determines the rate at which the sequence is executed. For instance, if the sequence frequency is set to 1 Hz, each setting in the sequence is output for 1 second.

HP-IB Operation

The following HP-IB information is specific to Hop RAM Sequence operation. Additional information on remote operation using HP-IB is provided in section 3.

3. HP-IB Programming

HP-IB Programming codes:

- **Function:** Set address of HOP RAM
Mnemonic: "HRA"
Form: Addresses 0 to 15 are valid, valid terminator is "ET"
Example: "HRA02ET" or "HRA 15 ET"
- **Function:** Set frequency of HOP RAM
Mnemonic: "FRH"
Form: 0 Hz to 600 kHz range, valid terminators are "HZ" and "KZ"
Example: "FHR 723.5 Hz"
- **Function:** Set amplitude of HOP RAM
Mnemonic: "APH"
Form: valid terminators are "UV", "MV", and "VL"
Example: "APH 1.999 VL"
- **Function:** Set phase of HOP RAM
Mnemonic: "PHH"
Form: valid range is 0 to 359.9 deg, valid terminators are "DC" or "RD"
Example: "PHH 90 DG" or "PHH 3.14 RD"
- **Function:** Write sequence string†
Mnemonic: "WSQ"
Form: Entry string is terminated by ";", CR/LF, or EOI.
Example: "WSQ0123456789ABCDEF;" or "WSQ0100010100010001000100100111;"
- **Function:** Copy attribute (freq, phase, amplitude) of the presently selected hop ram location into all 16 hop ram locations.
Mnemonic: "COPY"
Form: "FRH", "PHH", "APH" followed by "COPY"
Example: "HRA 02 ET APH COPY" or "PHH COPY"
- **Function:** Set burst length
Mnemonic: "BL"
Form: "BL" followed by length from 1 to 127, then "ET"
Example: "BL 127 ET"
- **Function:** Set hop frequency rate
Mnemonic: "RFQ"
Form: "RFQ" followed by value from 0.1 Hz to 10 kHz, then "HZ" or "KZ"
Example: "RFQ 600 Hz" or "RFQ 2.4 KZ"
- **Function:** Set waveform to be hopped
Mnemonic: "RWF"
Form: "RWF" followed by wave type. Valid wave types are : "SI", "RA", "TR", "DC", "NS", and "SQ".
Example: "RWF SI" or "RWFNS"
- **Function:** Set manual sequence pointer
Mnemonic: "MANP"
Form: "MANP" followed by value (1-750 for hex output base, 1-3000 for binary output base), then "ET". Value must be less than the sequence end value.
Example: "MANP 1 ET" or "MANP3000ET"
- **Function:** Set sequence pointer
Mnemonic: "SEQP"
Form: "SEQP" followed by value, then "ET". Value has same restrictions as "MANP" function.
Example: "SEQP 37 ET"
- **Function:** Set sequence end
Mnemonic: "SEQE"
Form: "SEQE" followed by value, then "ET". Value can range from 1 to 750 for hex output base and 1-3000 for binary output base.
Example: "SEQE 25 ET" or "SEQE 3000 ET"
- **Function:** Trigger sequence to run continuously.
Example: "RUNC"
- **Function:** Trigger sequence to run burst.
Example: "RUNS"
- **Function:** Run sequence manually.
Example: "RUNM"
- **Function:** Stop sequence.
Example: "STOP"
- **Function:** Set binary edit base.
Example: "BSB"
- **Function:** Set octal edit base.
Example: "BSO"
- **Function:** Set hexadecimal edit base.
Example: "BSH"
- **Function:** Set binary output base.
Example: "OBB"
- **Function:** Set hexadecimal output base.
Example: "OBH"
- **Function:** Output base readback.
Example: "ROB"
- **Function:** Set binary edit base.
Example: "BSB"
- **Function:** Set binary edit base.
Example: "BSB"

† The HP 8904A will accept a sequence string up to 250 characters in length. To fill up the available 750-character sequence string in the HP 8904A, three strings of 250 characters must be sent. If a binary sequence is being used, the EDIT BASE must be hexadecimal and the sequence string must be hex coded to transfer the full 3000 bits in three write sequence string commands. If binary base is used, it will require up to 12 transfers of 250 bits to send the full 3000 bits. A programming example is shown below for sending a binary sequence of 3000 bits to the HP 8904A.

Programming Example

```
10 Hpib=726
20 OUTPUT Hpib;"GM4"
30 OUTPUT Hpib;"HRA 0 ET"
40 OUTPUT Hpib;"APH 5 VL"
50 OUTPUT Hpib;"HRA 1 ET"
60 OUTPUT Hpib;"APH .2 VL"
70 OUTPUT Hpib;"BSH OBB"
80 OUTPUT Hpib;"RWF DC"
90 OUTPUT Hpib;"BL 4 ET"
100 OUTPUT Hpib;"SEQP 1 ET"
110 OUTPUT Hpib;"WSQ1B49AE92BFB4B6BE3A9CD780.....;"
120 !
130 !
140 OUTPUT Hpib;"SEQP 251 ET"
150 OUTPUT Hpib;"WSQ09A8D7E8CB56355673EACD32.....;"
160 OUTPUT Hpib;"SEQP 501 ET"
170 OUTPUT Hpib;"WSQ382E68AD7C9FB9A4129BF54C.....;"
180 OUTPUT Hpib;"RFQ 600 Hz"
190 OUTPUT Hpib;"RUNS"
200 END
```

! Go to HOP RAM SEQUENCE MODE.
! Set HOP RAM address to 0.
! Set amplitude for address 0 to 5 volts.
! Set HOP RAM address to 1.
! Set amplitude for address 1 to .2 volts.
! Set EDIT BASE to hex, OUTPUT BASE to bin
! Set waveform to be hopped to DC.
! Set burst length to 4.
! Set sequence pointer to beginning.
! Write the first 250
characters into the sequence string in
hexadecimal format.
! Move sequence pointer to accept next 250
! Write next 250.
! Move sequence pointer to accept last 250
! Write last 250.
! Set sequence hop frequency to 600 Hz.
! trigger sequence in burst mode.

FM Stereo Composite Generator

```

**  FM Stereo Composite Generator  **
Press NEXT/LAST keys.   f4 Exit

```

General Description

The FM Stereo Composite Generator function transforms the HP 8904A into a dedicated FM stereo encoder allowing you to test commercial FM broadcast stereo receivers. All of the associated parameters are adjustable to offer the widest possible range of testing.

Detailed Operation

To enable the FM Stereo mode from the Main Selection Level, press the **NEXT** key until **f1 FM Stereo** is displayed. Press the **f1** key to access the first level **FM Stereo Composite Generator** menu. Use the **NEXT** and **LAST** keys to access the other FM Stereo menus.

You can return the instrument to the Main Selection Level at any time by pressing the **SHIFT, MAIN** keys.

Second Menu

```

Tone: FREQ  1.000  kHz   f3 Mode Off
Composite AMPTD  1.000 V   f4 Pilot On

```

Tone: Frequency - This tone simulates the audio frequency information being broadcast. Change the frequency by pressing the **FREQ** key and entering the desired frequency (20 Hz to 15 kHz).

f3 Mode - Press the **f3** key to change the stereo mode. The following modes are available:

- Off
- R = L
- R = - L
- R only
- L only

Composite Amplitude - Change the composite amplitude by pressing the **AMPTD** key and entering the desired amplitude (0 to 10 V (p-p) into 50 Ω).

f4 Pilot - Press the **f4** key to enable or disable the stereo pilot signal.

Third Menu

```
Pilot: FREQ 19.000 kHz AMPTD 10.0 %  
PHASE 0.0 deg f4 Pilot On
```

Pilot Frequency - Change the stereo pilot signal frequency by pressing the **FREQ** key and entering the desired frequency (0.1 Hz to 600 kHz).

Pilot Amplitude - The pilot signal amplitude is entered as a percentage of the total composite signal amplitude. Change the amplitude by pressing the **AMPTD** key and entering the desired amplitude in percent (0.0% to 100.0%).

f4 Pilot - Press the **f4** key to enable or disable the stereo pilot signal. (Same function as in previous menu.)

PHASE - The pilot tone phase can be adjusted from 0.0° to 359.9°, relative to the rest of the composite waveform. Change the phase by pressing the **PHASE** key and entering the desired phase value in degrees or radians.

Fourth Menu

```
Carrier: FREQ 38.00 kHz
f2 Preemphasis Off f4 Exit
```

Carrier Frequency - Change the carrier frequency by pressing the **FREQ** key and entering the desired frequency.

f2 Preemphasis - Pre-emphasis in the HP 8904A is configured so that the entered composite level is achieved at the maximum tone frequency allowed (15 kHz). The rolloff of the composite level for frequencies <15 kHz follows the transfer function of the specified preemphasis time constant.

τ = pre-emphasis setting

$$f_{3dB} = \frac{1}{2\pi\tau}$$

Change the pre-emphasis by pressing the **f2** key. The following pre-emphasis settings are available:

- Off
- 25 μ s
- 50 μ s
- 75 μ s

HP-IB Operation

The following HP-IB information is specific to FM Stereo Composite Generator operation. Additional information on remote operation using HP-IB is provided in section 3.

Function	HP-IB Code	Description
Composite Level	CL	Form: CL <amplitude> <terminator> Example: "CL1.9VL" Set Composite Level. Valid terminators are VL, MV, and UV.
Frequency C arrier	CF	Form: CF <freq value> <terminator> Example: "CF38.0KZ" Set Carrier Frequency. Valid terminators are HZ and KZ.
P ilot	PF	Form: PF <freq value> <terminator> Example: "PF19.0K2" Set Pilot Frequency. Valid terminators are HZ and KZ.
T one	TF	Form: TF <freq. value> <terminator> Example: "TF1.0KZ" Set Tone Frequency. Valid terminators are HZ and KZ.
Pilot L evel	PL	Form: PL <level value> <terminator> Example: "PL10.0 PC" Set Pilot Level. Valid terminators are % and PC.
P hase	PP	Form: PP<phase value> <terminator> Example: "PP59.3DG" Set Pilot Phase. Valid terminators are DG and RD.
Pilot M ode	PL PTM	Form: PL <level value> Form: PTM <mode number> Example: "PTM0" "PTM1" Set Pilot Mode: 0 = Off, 1 = On
Preemphasis	P EM	Form: PEM <mode number> Example: "PEM0" "PEM3" Set Preemphasis Mode: 0 = Off, 1 = 25 μ s, 2 = 50 μ s, 3 = 75 μ s
Tone Mode	TMD	Form: TMD <mode number> Example: "TMD0" "TMD3" Set Tone Mode: 0 = Off, 1 is R = L, 2 is R = -L, 3 = R only, 4 = L only
Query T one P ilot P reemphasis	QTM QPM QEM	Read present tone mode. Read present pilot mode. Read present preemphasis mode.

Function	HP-IB Code	Description		
Data	?	Query Form	ASCII Data	Implied Units
		TF?	0000000.0	Hz
		TFIS?	0000000.0	Hz
		CF?	0000000.0	Hz
		CFIS?	0000000.0	Hz
		PF?	0000000.0	Hz
		PFIS?	0000000.0	Hz
		CL?	00.000000	Volts
		CLIS?	00.000000	Volts
		PP?	0000.0	Degrees
		PPIS?	0000.0	Degrees
		PL?	0000.0	Percent
		PLIS?	0000.0	Percent
		QPM?	0	Value (Same as input)
		QTM?	0	Value
		QEM?	0	Value

4

Output Two Signals at Once

Dual Output Ports

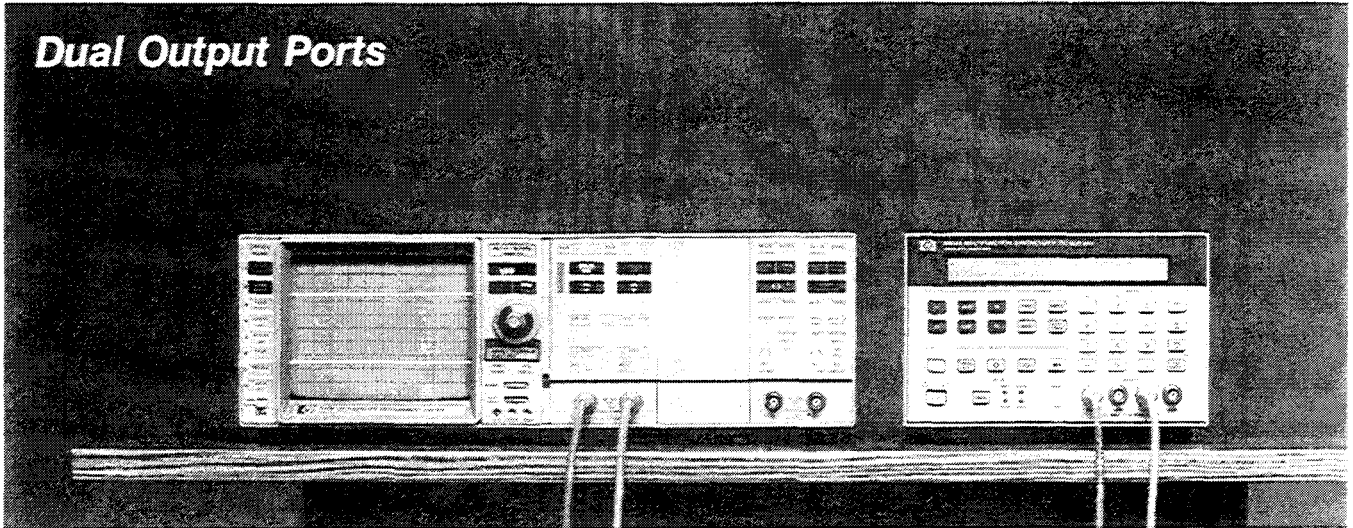

In this Chapter

In this chapter, you will learn to operate the Dual Output Ports provided by Configuration Option 02. If your HP 8904A is equipped with Option 02, this demonstration will show you how to:

- **Output a Signal at each Output Port**
- **Vary the Phase Relationship of the Signals at each Output Port**
- **Set Up Some Applications that use the Dual Output Ports**
- **Modulate at One Output Port and Sum at the Other (only for instruments that are also equipped with four channels, Option 01)**

Set Up Your Equipment

Connect your HP 8904A to the oscilloscope as shown above.

Note

A dual-trace oscilloscope is required to complete the demonstrations in this chapter.

Adjust Your Oscilloscope

DisplayAlternate
Volts/Division 1V (Channels A and B)
Coupling dc (High Impedance)
Time/Division 0.2 ms
Trigger Channel A

Select Chassis Ground

1. Press the blue **SHIFT** key and the **PRESET** key on the HP 8904A. Note that all four Output LEDs are lit on HP 8904A's equipped with Dual Output Ports.
2. Press the blue **SHIFT** key and then the **FLOAT** key to access the Output Float Control display.
3. Press the **1** key and then the **OFF** key to reference the HP 8904A's circuit ground to chassis ground at Output 1.
4. Press the blue **SHIFT** key and then the **FLOAT** key again.
5. Press the **2** key and then the **OFF** key to reference the HP 8904A's circuit ground to chassis ground at Output 2 as well. (Note that the **FLOAT** LEDs for Outputs 1 and 2 are now off.)
6. Adjust the Channel A trace on the oscilloscope to halfway between the top and the middle of the display, and the Channel B trace to halfway between the bottom and the middle of the display.

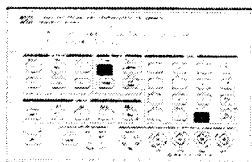

How to Output a Signal at each Port

The Dual Output Ports option provides you with two synthesized function generators. (Both a HIGH and a LOW output connection is provided for each function generator.)

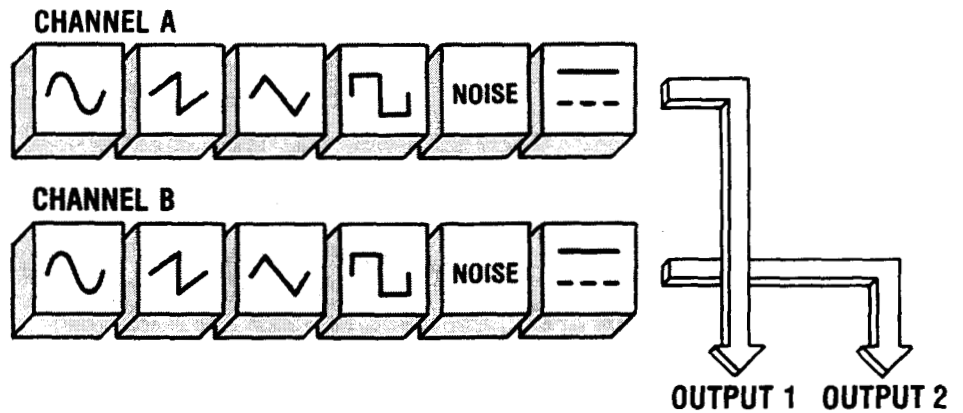

Figure 4-1. Channel and Output Configuration for the Option 02, Dual Output Ports.

1. Press the **f1** Channel Config. softkey to access the Channel Configuration Mode.

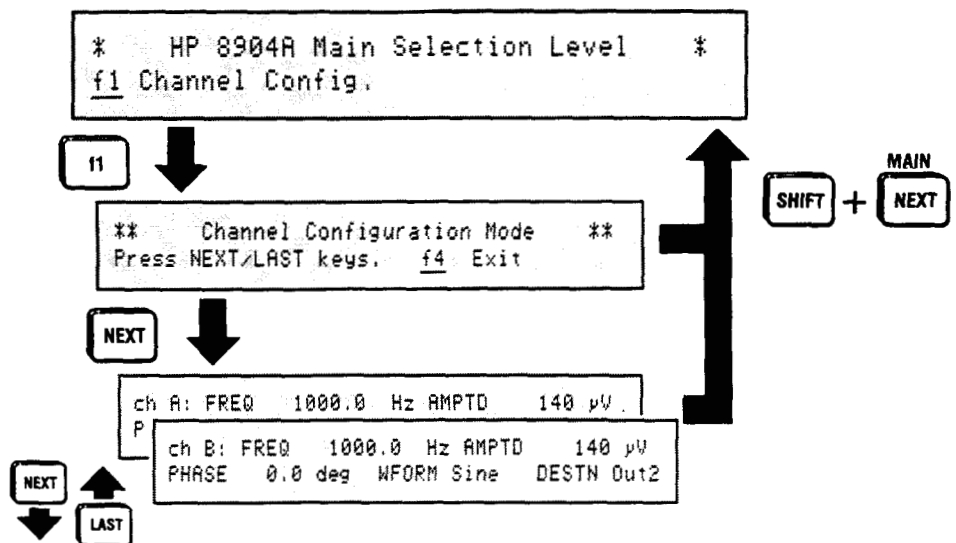

Figure 4-2. How to Access Option 02, Dual Output Ports Operation.

Output Port 1

2. Press the NEXT key to access the Channel A Configuration display. Notice that the destination for Channel A is already set to Output 1.

```
ch A: FREQ 1000.0 Hz AMPTD 140  $\mu$ V  
PHASE 0.0 deg WFORM Sine DESTN Out1
```

3. Press the AMPTD key and enter 1V.
4. Press the WAVEFORM key and then \square key to output a square wave from Channel A at Output Port 1.

Output Port 2

5. Press the NEXT key to access the Channel B Configuration display. Notice that the destination for Channel B is already set to Output 2.
6. Press the AMPTD key and enter 1V.
7. Press the WAVEFORM key and then the \nearrow key to select a ramp waveform. Two signals should now appear on the oscilloscope display (a square wave and a ramp wave).

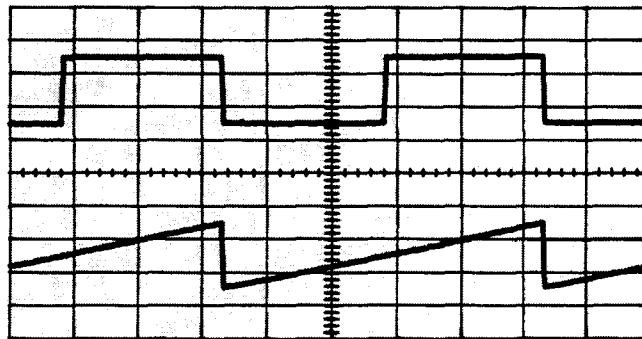

How to Vary the Phase

The HP 8904A gives you precise control of the phase relationship between the two function generators (to 0.1 degrees).

1. Press the **PHASE** key, the **INCR SET** key and enter 45 degrees.
2. Press the **↑** key to increment the phase of Channel B up in 45 degree steps. You should be able to see the phase of the Channel B signal shift on the oscilloscope relative to the Channel A signal each time you press the **↑** key.

If you continue to press the **↑** key, you will find that the HP 8904A does not respond to your 45 degree increment at 315 degrees. This is because the maximum phase shift allowed by the HP 8904A is 359.9 degrees.

How to Set Up Some Applications

Stereo Phase Test Signal

The following setup examples demonstrate two test applications that can be simplified using the Dual Output Ports.

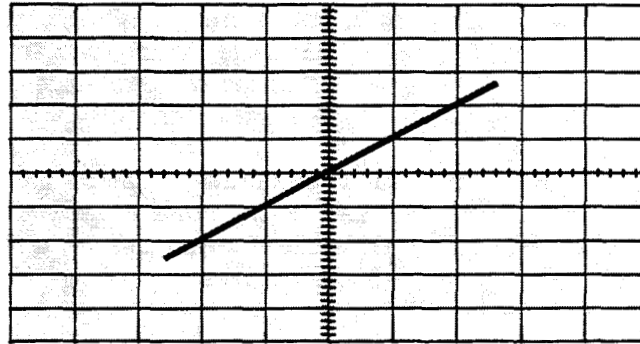

Application:

Used to align stereo audio cassette player (tape deck) heads.

Table 4-1. Instrument Settings for the Stereo Phase Test Signal.

Channel	Destination	Frequency	Amplitude	Phase	Waveform
A	Out 1	1 kHz	2.5V	0.0 deg	Sine
B	Out 2	1 kHz	2.5V	0.0 deg	Sine

Comments:

1. Connect Output Port 1 to the left input on the stereo and Output Port 2 to the right input.
2. Connect the stereo's left and right outputs to the oscilloscope.
3. Set the oscilloscope for A vs. B. (The pattern shown above represents the desired zero phase difference between the stereo's channels.)

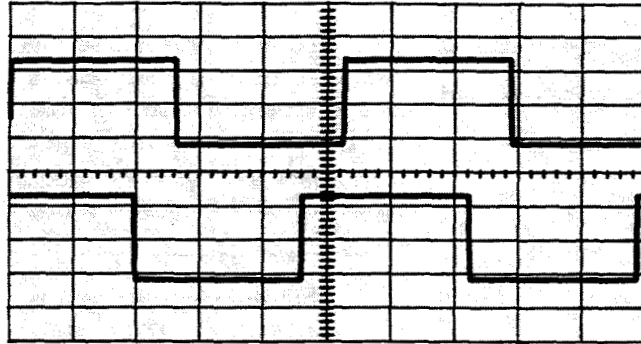
Variable Phase Signal**Application:**

Testing phase performance on two-channel devices (such as characterizing phase detectors, or testing servo system stability).

Table 4-2. Instrument Settings for a Variable Phase Signal.

Channel	Destination	Frequency	Amplitude	Phase	Waveform
A	Out 1	1 kHz	2.5V	0.0 deg	Square
B	Out 2	1 kHz	2.5V	45 deg	Square

Comments:

1. Adjust Channel B's phase to vary the phase differential. (The HP 8904A provides 0.1 degree phase increments.)

If your HP 8904A is equipped with Option 02 only, you have completed the operating demonstrations provided in this guide for your instrument. The following demonstration (beginning on the next page) is for instruments that are also equipped with four channels (Option 01).

How to Modulate and Sum

If your HP 8904A also has four channels (Option 01), you can use the additional channels (C and D) to modulate or sum with the two output signals. In this demonstration, you will configure the HP 8904A to modulate Channel A using Channel B and output the modulated signal at Output Port 1. You will then sum Channels C and D and output the resulting signal at Output Port 2.

Note

This demonstration assumes that the parameters for Channels A and B are configured as described in the previous demonstration, "How to Output a Signal at Each Port." If they are not, please configure the Channels as shown in Table 4-3 before you begin this demonstration.

Table 4-3. Instrument Settings for Channels A and B.

Channel	Destination	Frequency	Amplitude	Phase	Waveform
A	Out 1	1 kHz	1V	0.0 deg	Square
B	Out 2	1 kHz	1V	315 deg	Ramp
C	Off				
D	Off				

**Modulate at
Output Port 1****Channel A**

1. Press the **LAST** key as needed to access the **Channel A Configuration** display.
2. Enter a frequency of 20 kHz.

Channel B

3. Press the **NEXT** key, the **PHASE** key and enter 0 degrees for Channel B.
4. Press the **WAVEFORM** key and the \sim key.
5. Press the blue **SHIFT** key, the **DESTN** key and then the **AM** key.
6. Press the **AMPTD** key and enter 100%. Channel B is now configured to amplitude modulate Channel A. (Adjust the oscilloscope if necessary to get a stable display.)

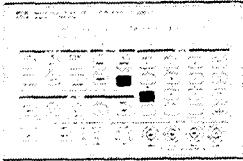

Sum at Output Port 2 Channel C

7. Press the NEXT key twice to access the Channel C Configuration display.
8. Press the FREQ key and enter 20 kHz.
9. Press the WAVEFORM key and the \square key.
10. Press the blue SHIFT key, the DESTN key and then the 2 key to route Channel C to Output Port 2.
11. Press the AMPTD key and enter 1V.

Channel D

12. Press the NEXT key to access the Channel D Configuration display.
13. Press the blue SHIFT key, the DESTN key and then the 2 key to route Channel D to Output Port 2.
14. Press the AMPTD key and enter 1V. The HP 8904A is now configured to sum Channels C and D and output the resulting waveform at Output Port 2.

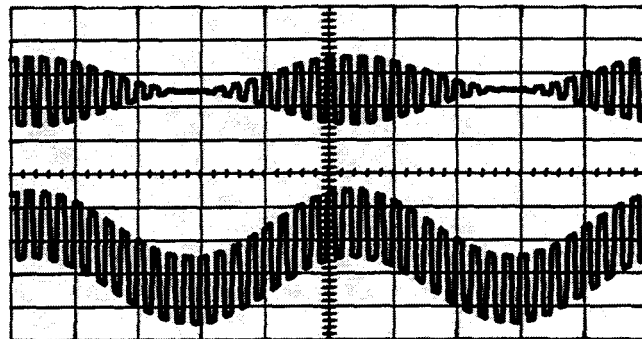

Figure 4-3. Two 20 kHz Square Wave Signals, One Modulated by 1 kHz (top), and the Other Summed with 1 kHz (bottom).

Table 4-4 shows the parameters you have entered for each channel. Instruments that have four channels and Dual Output Ports provide maximum flexibility for meeting the needs of applications that require both modulated and unmodulated signals.

Table 4-4. Instrument Settings for the Four Channel, Dual Output Ports Demonstration.

Channel	Destination	Frequency	Amplitude	Phase	Waveform
A	Out 1	20 kHz	1V	0.0 deg	Square
B	AM	1 kHz	100%	0.0 deg	Sine
C	Out 2	20 kHz	1V	0.0 deg	Square
D	Out 2	1 kHz	1V	0.0 deg	Sine

Remember

Only Channel A can be modulated by the other channels, and each channel can have only one destination at a time (Output Port 1, Output Port 2, or as a modulation source to Channel A.)

Things to Remember About Dual Output Ports Operation

Figure 4-4 provides an overview of the HP 8904A's operation when it is equipped with four channels and Dual Output Ports.

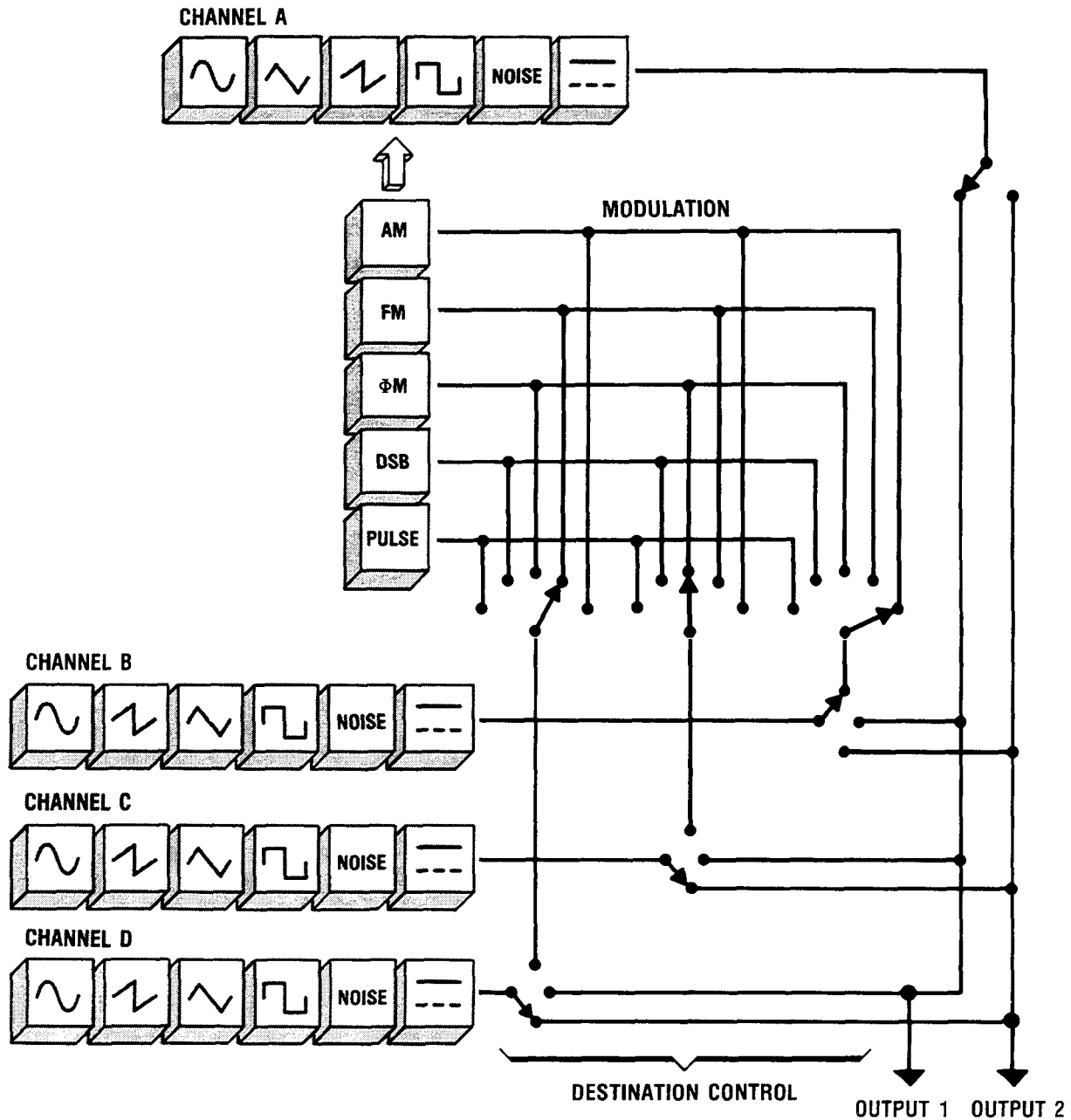

Figure 4-4. Channel and Output Configuration for HP 8904A's Equipped with Four Channels and Dual Output Ports.

**Key Points
About Operation**

Table 4-5 contains operating considerations you should keep in mind as you configure the HP 8904A's four channels for dual output operation.

Table 4-5. Operating Considerations for Dual Output Port Operation using Four Channels.

Operation	Considerations
Output Signal	<ul style="list-style-type: none">• Each Channel can be output at either Output 1 or 2.
Configure Channels	<ul style="list-style-type: none">• All considerations shown in Chapter 2 for Four Channel Operation still apply.

5

Hop the Output Signal

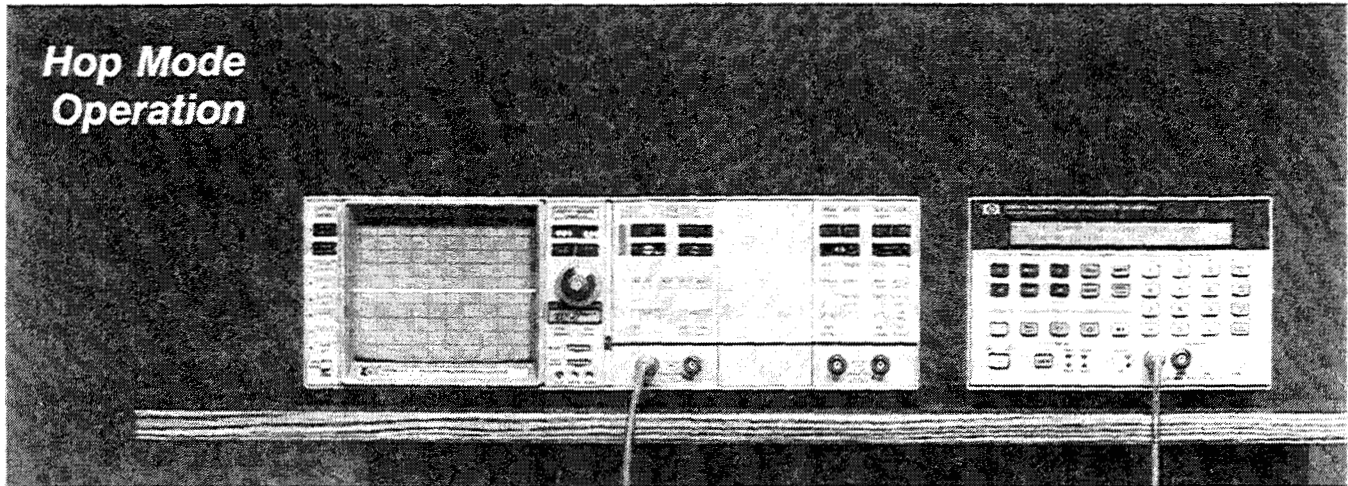

In This chapter

In this chapter, you will learn how to operate the Hop Mode capabilities provided by Configuration Option 03. If your HP 8904A is equipped with Option 03, this Hop Mode demonstration will teach you how to:

- **Access Hop Mode Operation**
- **Configure Channel A for Hopping its Frequency, Amplitude and Phase Settings**
- **Fast Hop Channel A**

Set Up Your Equipment

Connect your HP 8904A to the oscilloscope as shown above.

Adjust Your Oscilloscope

Display Channel A
Volts/Division 1V
Coupling dc (High Impedance)
Time/Division 0.2 ms
Trigger Channel A

Select Chassis Ground

1. Press the blue SHIFT key and the PRESET key.
2. Press the blue SHIFT key and then the FLOAT key.
3. Press the 1 key and then the OFF key to reference the HP 8904A's circuit ground to chassis ground at Output 1. (Note that the FLOAT LED for Output 1 is now off.)
4. Adjust the oscilloscope trace if necessary to position the trace at center scale.

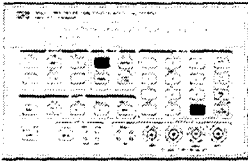

How to Access Hop Mode Operation

1. Press the **f1** Channel Config. softkey to access the Channel Configuration Mode.
2. Press the **NEXT** key to access the Channel A Configuration display. The HP 8904A will output Channel A when the Hop Mode is turned on. The HP 8904A will allow you to hop the frequency, amplitude and/or phase settings of the Channel A signal.

```
ch A: FREQ 1000.0 Hz AMPTD 140 μV
      PHASE 0.0 deg WFORM Sine DESTN Out1
```

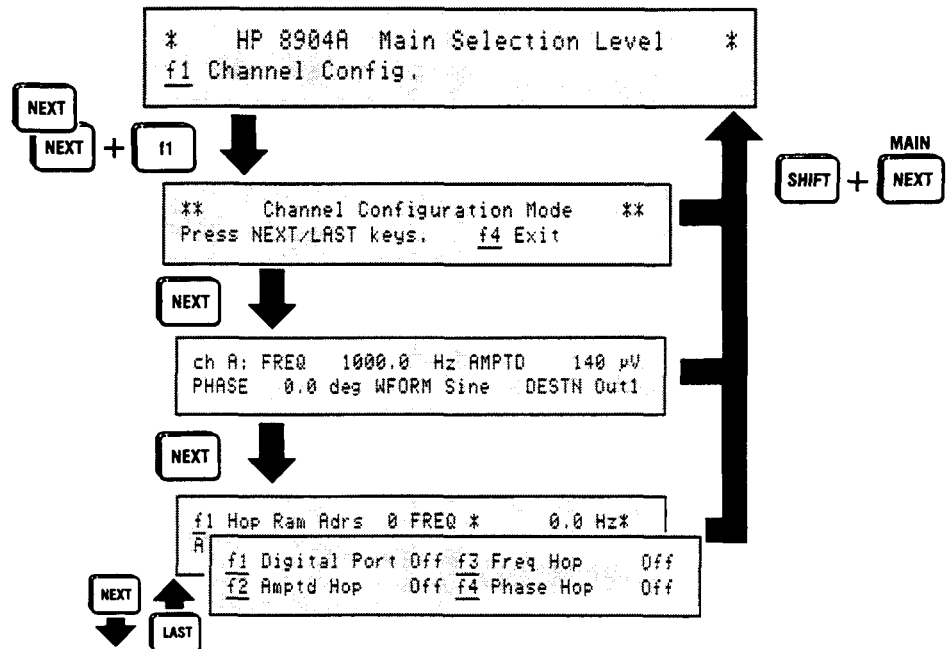

Figure 5-1. How to Access Hop Mode Operation.

How to Configure Channel A for Hopping

The HP 8904A enables you to hop Channel A's frequency, amplitude and/or phase settings. This demonstration will step you through the process of entering the settings you wish to have Channel A hop to.

Note Only Channel A's settings can be hopped.

1. Press the **AMPTD** key and enter 1V. The 1 kHz, 1 Vpk Channel A signal should now appear on your oscilloscope.

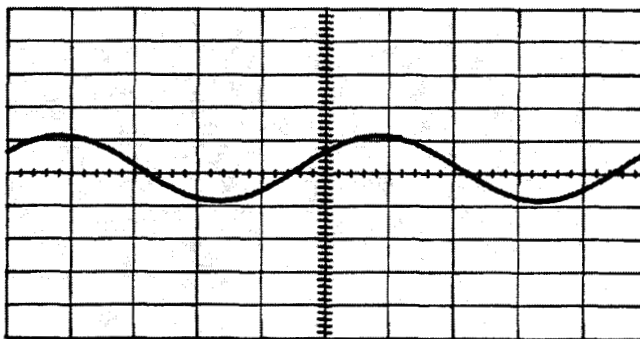

Enter the Hop Parameters

Note If your HP 8904A is equipped with four channels, the Parameter Entry displays for Channels B, C and D will precede the Hop Configuration display.

2. Press the **NEXT** key until the **Hop Configuration display** appears. This display allows you to enter the settings you wish to have Channel A hop to. The HP 8904A provides 16 Hop Registers (0 through 15).

```
f1 Hop Ram Adrs 0 FREQ *      0.0 Hz*
AMPTD *         0 μV * PHASE *   0.0 deg *
```

Hop Register 0

3. Press the **FREQ** key and enter 5 kHz.
4. Press the **AMPTD** key and enter 2V. That is all it takes to store parameters in a Hop Register.

Hop Register 1

5. Press the **f1 Hop Ram Adrs** softkey and then the **↑** key. The HP 8904A is now ready to accept parameters for Hop Register 1.
6. Press the **FREQ** key and enter 10 kHz.
7. Press the **AMPTD** key and enter 3V.

Hop Register 2

8. Press the **f1 Hop Ram Adrs** softkey, the **2** key and then the **ENTER** key. You can access the various Hop Registers by using either the **↑** or **↓** keys or by entering the number of the desired register directly.
9. Press the **FREQ** key and enter 15 kHz.
10. Press the **AMPTD** key and enter 4V.

Hop Register 3

11. Press the **f1 Hop Ram Adrs** softkey and the **↑** key to access Hop Register 3.
12. Enter a frequency of 20 kHz and an amplitude of 5V.

You have now entered frequency and amplitude parameters into four Hop Registers (0 through 3).

Table 5-1. Parameter Entries for Hop Registers 0 through 3.

Hop Register	Frequency (kHz)	Amplitude (V)	Phase (deg)
0	5.0	2.0	0.0
1	10.0	3.0	0.0
2	15.0	4.0	0.0
3	20.0	5.0	0.0

Save and Recall Your Hop Parameters

The HP 8904A will reset the contents of all of its Hop Registers to their default values (0) when it exits the Channel Configuration Mode to return to the Main Selection Level. When you set up your own Hop Mode applications, you can easily retain all of the hop parameters that you have entered by storing them in a Save Register. When you set up a Save Register (as described in Chapter 1 of this guide), the HP 8904A will store the current parameter settings for all of its Hop Registers as well as all of the current settings for Channel A.

Remember

When you Recall a Save Register, the HP 8904A returns all of its operating modes to the same settings that existed when the Save Register was selected.

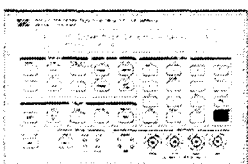

Specify the Hop Parameters

13. Press the **f1 Hop Ram Adrs** softkey, the **0** key and then the **ENTER** key to return to the first Hop Register.
14. Press the **NEXT** key to access the **Hop Parameter Selection** display. This display allows you to specify which of Channel A's settings you wish to hop.

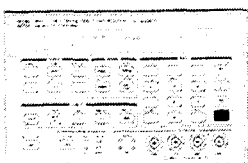
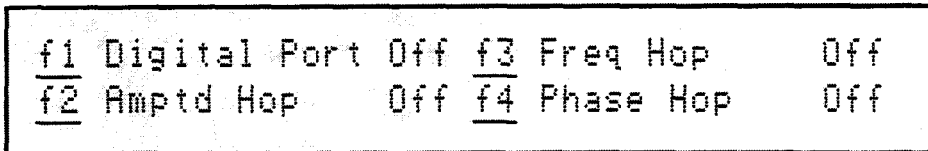

15. Press the **f2 Amptd Hop** softkey and then the **ON** key. You have configured the HP 8904A to hop Channel A's amplitude setting. The amplitude of the signal on your oscilloscope should increase to 2 Vpk.

The HP 8904A is now outputting its Channel A signal at the amplitude specified in Hop Register 0 (2 Vpk). Note that the frequency of the output signal however, is not 5 kHz as specified in Hop Register 0. The HP 8904A only uses the parameters from the Hop Register that have been turned on (amplitude in this case). Since the frequency parameter has not yet been turned on, the HP 8904A continues to use Channel A's frequency setting.

16. Now press the **f3 Freq Hop** softkey and then the **ON** key. Now the frequency of Channel A is also being set by Hop Register 0.

**Select the
Hop Registers**

17. Press the **LAST** key to return to the Hop Configuration display. Note that the HP 8904A has removed the asterisk (*) from the frequency and amplitude entry fields on the display to signify that they are currently turned on.

```
f1 Hop Ram Adrs 0  FREQ  5.000 kHz
AMPTD  2.00 V  PHASE *  0.0 deg *
```

18. Press the **f1 Hop Ram Adrs** softkey and then the **↑** key. Continue to press the **↑** key until you reach Hop Register 3. Notice the frequency and amplitude of the signal displayed on the oscilloscope hop to the values specified in the selected Hop Register each time the **↑** or **↓** keys are pressed.
19. Now press the **2** key and then the **ENTER** key. You can also select the Hop Registers directly in whatever order you wish.
20. Press the **LAST** key until the Channel A Configuration display appears. The HP 8904A display informs you that the frequency and amplitude settings for Channel A are now being set by the Hop Registers.

```
ch A: FREQ *Hop Ram*  AMPTD *Hop Ram*
PHASE  0.0 deg  WFORM Sine  DESTN Out1
```

Note

Although Channel A's phase setting was not hopped in this demonstration, it can also be configured to hop using the procedures described in this demonstration for hopping the frequency and amplitude settings.

How to Fast Hop Channel A

The HP 8904A allows you to fast hop between the parameters you have entered (at switching speeds of up to 8 μ s) using the rear-panel DIGITAL PORT. The DIGITAL PORT provides inputs for the Hop Register address selection lines. The selection address for each register (Hop Ram Adrs) is shown on the Hop Configuration display. The registers can be selected in whatever order you desire. The following steps describe how to use the DIGITAL PORT for fast hopping Channel A.

1. Press the NEXT key to return to the Hop Parameter Selection display.

<u>f1</u> Digital Port	Off	<u>f3</u> Freq Hop	On
<u>f2</u> Amp'd Hop	On	<u>f4</u> Phase Hop	Off

Enable the DIGITAL PORT

2. To enable the DIGITAL PORT, press the **f1 Digital Port** softkey and then the **ON** key. The HP 8904A is now ready to receive Hop Register addresses via its rear-panel DIGITAL PORT.

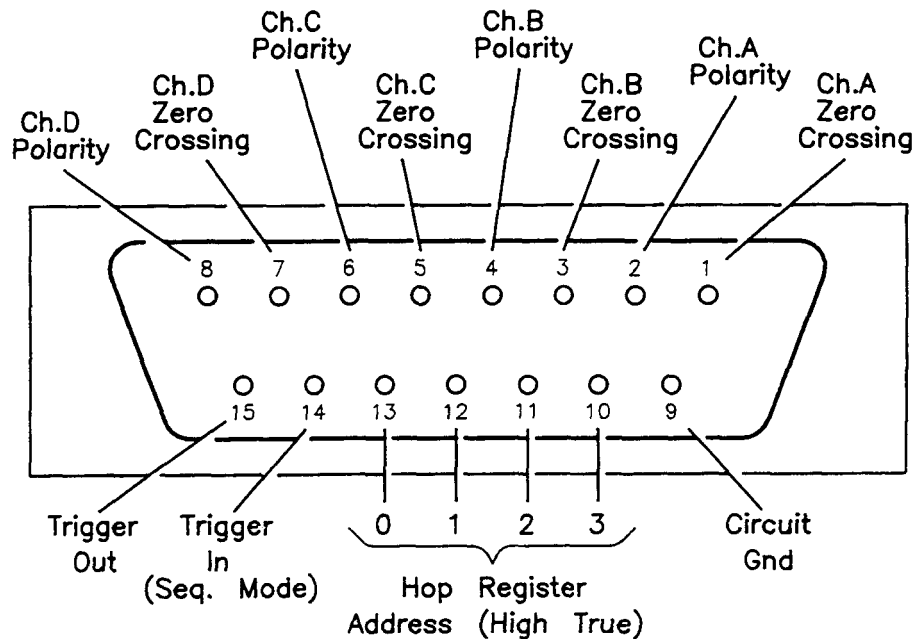

Figure 5-2. Pin Connect Diagram for the Rear-Panel DIGITAL PORT.

Fast Hop Example

Figure 5-3 shows an example of an address selection circuit for fast hopping an HP 8904A (that is equipped with Option 01 and 03) at the rate of the Channel D frequency setting. (An external timing source can be used in place of the Channel D signal to increase the hop rate.)

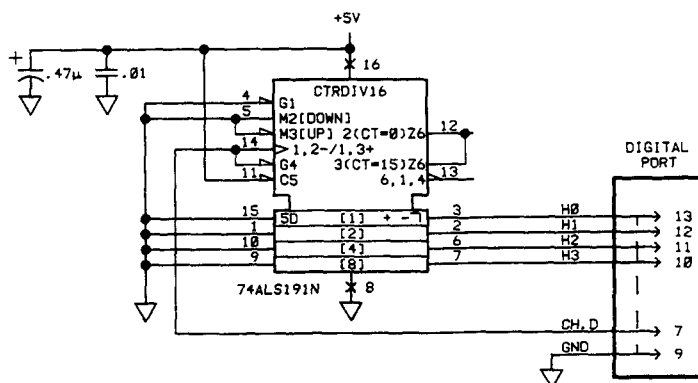

Figure 5-3. Example Address Selection Circuit for Fast Hopping the HP 8904A.

Table 5-2. Instrument Settings for the Fast Hopping Example.

Channel	Destination	Frequency	Amplitude	Phase	Waveform
A	Out 1	1 kHz	140 μ V	0.0 deg	Sine
B	Off	62.5 Hz	5V	0.0 deg	Square
C	Off	0 Hz	140 μ V	0.0 deg	Sine
D	Off	500 Hz	140 μ V	0.0 deg	Sine

The following BASIC program can be used to set up the HP 8904A for this example over its HP-IB.

```

10 I=EXTHOP 6/25/87
20 CLEAR
30 DISP "** EXT. HOP RAM SETUP
   DEMO **"
40 RESET 7
50 A=726
60 OUTPUT A;"GM0"
70 OUTPUT A;"FC10FFC20F"
80 FOR I=0 TO 15
90 A#="HRA"&VAL$(I)
100 OUTPUT A;"HRA";I;"ET"
110 OUTPUT A;"FRH";I+1;"KZ"
120 OUTPUT A;"FRD500HZ"
130 OUTPUT A;"WFBS0"
140 OUTPUT A;"APBSVL"
150 OUTPUT A;"FRB62.5HZ"
160 OUTPUT A;"FRD6KZ"
170 OUTPUT A;"APH";(I+1)*.5;"VL"
180 NEXT I
190 OUTPUT A;"DPEONFHROHARON"
200 OUTPUT A;"PF"
210 DISP "LOAD DONE"
220 STOP

```

Things to Remember About Hop Mode Operation

You have now completed the procedures for setting up Hop Mode operation. The following outline lists the key steps for setting up your HP 8904A to hop Channel A's frequency, amplitude and phase settings.

1. Enter the desired parameters into each Hop Register (0 through 15).
2. Specify which of Channel A's settings you wish to hop.
3. Select the Hop Registers by entering each Hop Register address via the front-panel keys or the rear-panel DIGITAL PORT.

Figure 5-4 provides an overview of the HP 8904A's Hop Mode capabilities.

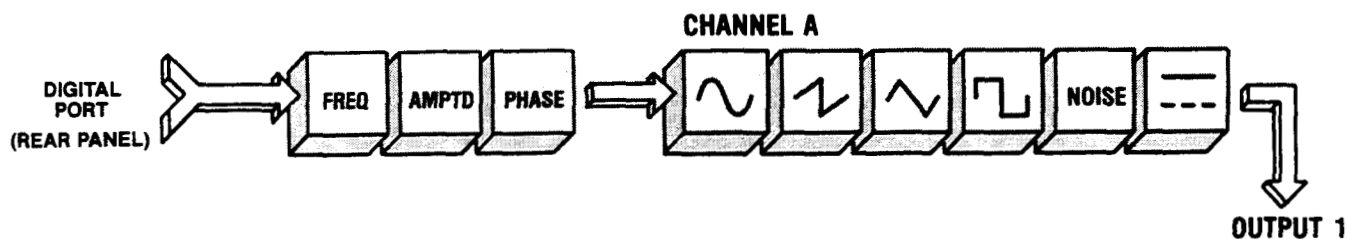

Figure 5-4. Simplified Block Diagram of the Hop Mode Configuration.

**Key Points
About Operation**

Table 5-2 contains operating considerations you should keep in mind as you configure your HP 8904A for Hop Mode operation.

Table 5-3. Operating Considerations for Hop Mode Operation.

Operation	Considerations
Configure Channel A	<ul style="list-style-type: none"> • Only Channel A's parameters can be hopped. • If your HP 8904A is equipped with four channels (Option 01), Channel A can be hopped while it is being modulated or summed with other signals except that the amplitude setting cannot be hopped when AM or DSB modulation is selected, and the phase setting cannot be hopped when ΦM is selected. • Hop Mode cannot be used in conjunction with any of the three Signal Sequence Modes provided by Option 01.
Output Signal	<ul style="list-style-type: none"> • If your HP 8904A has Dual Output Ports (Option 02), Channel A can be hopped at one Output Port while another signal is being output at the other output port.
Fast Hop	<ul style="list-style-type: none"> • The HP 8904A can be fast hopped (at switching speeds of up to 8 μs) using the rear-panel DIGITAL PORT. Fast hopping requires an external address selection source. • The HP 8904A can be hopped over its HP-IB at switching speeds of up to 8 ms.

A

Installation

Unpack Your HP 8904A

Inspect the shipping container for damage. If the shipping container is damaged or the cushioning material inside is stressed, keep them until you have checked the shipment for completeness and proper operation.

If components are missing from your shipment, or if there is mechanical damage or defect, notify the nearest Hewlett-Packard office. If the shipping container or cushioning material shows signs of stress, notify the carrier as well as the Hewlett-Packard office. Keep the shipping materials for inspection by the carrier.

Connect Power

The HP 8904A Multifunction Synthesizer requires a power source of 100 to 120 Vac ($\pm 10\%$) at 48 to 440 Hz, or 220 to 240 Vac ($\pm 10\%$) at 48 to 66 Hz. Power consumption is 80 VA maximum. If you need further information about the power requirements for your instrument, refer to the HP 8904A Operation and Calibration Manual.

Warning

This is a Safety Class I product (i.e., provided with a protective earth terminal). An uninterruptible safety earth ground must be provided from the Mains power source to the product input wiring terminals, power cord, or supplied power cord set. Whenever it is likely that the protection has been impaired, the instrument must be made inoperative and be secured against any unintended operation.

Turn On Instrument

If you are operating this instrument in extreme environmental conditions, refer to the HP 8904A Operation and Calibration Manual for specific operating limitations.

B

Help Messages

Interpreting the Help Messages

When the HP 8904A detects an inappropriate operating condition (such as when an inactive key is pressed), it beeps to let you know that a message about the condition is available on the Help display.

The HP 8904A's Help display is accessed by pressing the blue **SHIFT** key and then the **HELP** key. Table C-1 lists the Error Number for each Help Message displayed by the HP 8904A along with a brief description of the operating conditions that will cause the HP 8904A to display the message.

```
* Last reported error was no. 0 *  
No Error
```

Table B-1. Error Numbers and Description Listings for the HP 8904A's Help Messages. (1 of 4)

Error Number	Description
0	There is no new message.
1	A key was selected without specifying what the data was related to.
2	The key selected does not correspond to the function selected.
3	Invalid HP-IB address entry. (Only 00-30 (decimal) are valid entries.)
4	The \uparrow or \downarrow key cannot be used with this function.
10	The instrument cannot access the output board that connects to the OUTPUTS 1 connector. Refer to the HP 8904A Service Manual to isolate the problem.
11	A hardware error was detected by the power-up checks. Refer to the HP 8904A Service Manual to isolate the problem.
12	The reference loop of the Digital Synthesis (A2) assembly is out of lock. Refer to the HP 8904A Service Manual to isolate the problem.

Table B-1. Error Numbers and Description Listings for the HP 8904A's Help Messages. (2 of 4)

Error Number	Description
16	The Special Function display can only be accessed from the Main Selection Level.
13	A reverse power error was detected on an output board. (Disconnect the affected output from any external equipment and re-enter the key sequence that originally resulted in the error. If an error is still detected by the instrument, a reverse power problem still exists.)
14	The recalled Save Register does not contain a SAVE setting.
15	The selected function cannot be performed in the present mode. (For example, the FREQ function cannot be executed directly from the Main Selection Level.)
17	An invalid Special Function number was entered. (Only Special Functions 0 - 15 (decimal) may be entered.)
18	The Special Function number input was too large for the instrument to recognize it as data. This condition occurs when the data input is greater than 65535. (Refer to Error Message 17 concerning the range of Special Functions available.)
19	The number entered was too large for the function selected.
20	Increment Set is not available with the function selected.
22	An operation was directed to an output board which does not exist.
24	There are no settable modes or functions at this instrument level. (For example, in Hop Mode Operation the Hop Parameter display lists only four keys that will perform a function in this mode; f1, f2, f3 and f4. Any other key, such as AMPTD, has no meaning in this mode and will result in this error.)
	-Channel Configuration Errors-
31	Instrument is not configured for destination control.
	-Hewlett-Packard Interface Bus (HP-IB) Errors -
41	HP-IB numeric input error. Exponent too large or improper number format.
42	HP-IB numeric input error. The number was too large or too small, or a negative value was received when a positive value was required.
43	A number value was sent via HP-IB when one was not expected.
44	Invalid unique data was input via HP-IB. (Unique data specifies the Waveform, Modulation Type, Modulation On/Off Control, and Filter Selection, when entering a data string via HP-IB.)
45	Unique data was received via HP-IB when none was expected. (Refer to Error 44 for an explanation of unique data.)
46	An invalid terminator for the present data type was received via HP-IB. (A data terminator specifies the units of the data entered; i.e., Hz, Degrees, Volts, Seconds, Percent, etc; the ENTER command is also included in this group.)

Table B-1. Error Numbers and Description Listings for the HP 8904A's Help Messages. (3 of 4)

Error Number	Description
47	A Data Terminator was received via HP-IB when none was expected. (Refer to Error 46 for an expansion of data terminators.)
48	A combination of errors 41 through 47 probably exists. (Confirm that at least one of these errors exists and correct it. Enter the data again and read any error messages that result; an error number other than 48 should be displayed. The second error message should help to further isolate the error until it is eliminated.)
	-Signal Sequence Mode Errors-
50	Time value entered is out of range.
51	On and Off Time values cannot both be zero.
52	Amplitude value entered is out of range.
53	Frequency value entered is out of range.
54	Tone Number entered is out of range. [Only tone numbers 0-F (Hexadecimal) are valid.]
55	Sequence Index value entered is out of range. (Valid Range is 1-250.)
56	Sequence End value entered is out of range. (Valid Range is 1-250.)
57	The number entered is not valid in the Sequence Base selected. (Either the Binary, Octal, or Hexadecimal base numbering system is used to specify the Sequence Index and Sequence End. For example, you may not use the character '9' when you have previously specified the Octal base, since this number does not exist in that numbering system.)
58	Command not permitted in this mode.
59	Command not available in present window.
	-Destination Control Errors-
101	Channel A cannot be used as a source for AM, FM, DSB, Phase or Pulse modulation. (Channel A can be modulated, but it cannot be used as a modulation source.)
102	Channel A has a Waveform of dc and cannot be modulated.
103	A channel which has a Waveform of dc cannot be used as a modulation source.
104	An operation was directed to an output board which does not exist.
105	AM and DSB are mutually exclusive modulations and one is already active.
106	An attempt was made to use a second summer. For this configuration of two summers, only channels A+B with channels C+D is permitted.
107	The Hop Ram is presently enabled as this modulation source.
108	The Frequency set value selected is greater than the permitted maximum for pulse modulation.

Table B-1. Error Numbers and Description Listings for the HP 8904A's Help Messages. (4 of 4)

Error Number	Description
109	The Frequency set value selected is greater than the permitted maximum for this waveform.
110	Either AM or DSB modulation is active so Amplitude Hop Ram cannot be changed.
111	The present value of the Hop Ram amplitude settings will exceed the maximum permitted value and therefore the Amplitude Hop Ram cannot be turned on.
112	The present value of the Hop Ram frequency settings will exceed the maximum permitted value and therefore the Frequency Hop Ram cannot be turned on.
113	The attempted Frequency Hop Ram set value is greater than the permitted maximum for this waveform.
114	Phase modulation is presently active, therefore Phase Hop cannot be changed.
115	The present Channel A waveform cannot be used at the present frequency setting of Channel A if the Frequency Hop Ram is disabled.
	-Miscellaneous Errors-
121	The amplitude value selected is greater than the permitted maximum.
122	The amplitude value selected results in a sum which is greater than the maximum permitted value.
123	The frequency value selected is greater than the maximum permitted value.
124	When the Amplitude Hop Ram was disabled, the last Channel A amplitude setting could not be used with present instrument parameters. (Adjust the the Channel A amplitude to within non-Hop-Ram limits.)
150	The selected Waveform cannot be generated at the present frequency setting.
151	The dc Waveform can only be selected for a channel which has an Output Port or Off as a destination.
152	Channel A Waveform cannot be changed to dc while being modulated.
153	You can sum only one channel with a dc Waveform into an output board, and one is already active.
160	An operation was directed to an output board which does not exist.

C

HP-IB Codes

Code Listings for the HP 8904A

This appendix contains listings of the HP-IB programming codes for the HP 8904A. The codes are arranged in four tables. The first table (Table C-1) contains the HP-IB codes for the functions that are standard to all HP 8904A configurations. Tables C-2 through C-4 contain the commands that are unique to each of the Configuration Options (01, 02 and 03). A sample program is presented after each table to demonstrate the use of the codes.

Table C-1. HP-IB Codes for the Standard HP 8904A Functions (1 of 4)

Function	HP-IB Code	Description
Amplitude	AP	Form: AP<Channel><Amplitude Value><Terminator> Example: "APA1VL" Set amplitude of a channel. Valid terminators for amplitude are VL, MV and UV.
Backlight	BO	Backlight On
	BF	Backlight Off
Beep	BP	Beep
Exit	EM	Form: EM Exit Mode. Exit Mode needs no data.
Filter	FS	Form: FS<Output Number><Filter> Example: "FS1AU" Output Board Filter Select. Designate Output Port 1 (or 2 if the instrument is equipped with Option 02) followed by (no space) the desired filter.
	SH	Eliptic (Sharp Cutoff)
	LO	Gaussian (Low Overshoot)
	AU	Auto (Automatic)
Float Control	FC	Form: FC<Output Number><ON or OF> Example: "FC1ON" Float Output On/Off Control. Designate Output Port 1 (or 2 if the instrument is equipped with Option 02) followed by (no space) the desired state.
Frequency	FR	Form: FR<Channel><Frequency Value><Terminator> Example: "FRA20KZ" Set frequency of channel. Valid terminators for frequency are HZ and KZ.

Table C-1. HP-IB Codes for the Standard HP 8904A Functions (2 of 4)

Function	HP-IB Code	Description
Go To	GM	<p>Form: GM <Mode Number> Example: "GM4" Go to Mode. Go to Mode accepts the values 0-9.</p> <p>0 = Channel Configuration Mode. 1 = (Reserved for future options.) 2 = Tone Sequence Mode. 3 = DTMF Sequence Mode. 4 = Digital Sequence Mode. 5-9 = (Reserved for future options.)</p>
Help	HP	This function will return a three digit ASCII string representing the Error Number (000 to 255 where 0 means no error reported). Refer to Appendix B for the list of Help Messages.
ID	ID	<p>Read the ID message. A read of the ID string sends 80 characters to the requesting controller in the following format:</p> <p>"HP8904A Opts 01/02/03" "Firmware Revision XXXXXa Serial No XXXXX"</p>
Increment Set	IS UP DN	<p>Form: <Parameter>IS<Value> Example: "APA1VL" Increment set. Used for any parameter that can be modified by the Up and Down commands.</p> <p>UP Increment DN Down</p> <p>Examples: "PHAUP", "UPDNDN", "DN" UP and DN can be used for settings which have an associated increment set value. They can be prefixed by a specific function, or used by themselves to modify the presently active function.</p>
Last	<	Use like the LAST key to access the previous display.
Next	>	Use like the NEXT key to access the next display.
Off	OF	Off
On	ON	On
Output Control	OO	<p>Form: OO<Output Number><ON or OF> Example: "OO1OF" Output On/Off Control. Designate Output Port 1 (or 2 if the instrument is equipped with Option 02) followed by (no space) the desired state.</p>

Table C-1. HP-IB Codes for the Standard HP 8904A Functions (3 of 4)

Function	HP-IB Code	Description
Phase	PH	Form: PH<Channel><Phase Value><Terminator> Example: "PHA45DG" Set phase of a channel. Valid terminators are DG and RD.
Phase Reset	PR	Phase reset establishes a common zero reference for the channels.
Preset	PS	Instrument Preset
Query Data	?	Form: <Data Setting> Examples: "FRA?", "FRAIS?" "?" Query of existing data values is achieved by placing the "?" term after the desired item name. A query terminates any presently running sequence.
Recall	RC	Form: RC<Register> Example: "RC11" Recall. Valid data values for Recall are 0-11.
Reverse Power	RP	Reset reverse power protection.
Save	SV	Form: SV<Register> Example: "SV1" Save. Valid data values for Save are 0-11.
Service Request	RM	Form: RM Read Service Request Mask. The present value of the SRQ mask is returned, 000-191.
	SM	Form: SM<Data Value> Examples: "SM128", "SM0" Set Service Request Mask. Valid data = 0-255
Special Functions	SF	Form: SF<Data Value> Examples: "SF4", "SF12763" Set or Reset Special Functions. The value of the Special Function flag can be read at any time but can only be set at the Main Selection Level. The flag is a composite of bit flags. A Special Function operation configures all 16 bits of the flag (that is, any previously set flags are lost). Do not leave a space between the mnemonic and the data value.

Table C-1. HP-IB Codes for the Standard HP 8904A Functions (4 of 4)

Function	HP-IB Code	Description
Terminators	KZ HZ DG RD VL MV UV ET SC MS % PC	Kilohertz Hertz Degrees Radians Volts Millivolts Microvolts Enter Seconds Milliseconds Percent Percent
Time Base	EO	Example: "EO" Read External Reference Status. This function allows you to determine whether the Time Base reference is external or internal. If the External reference is on, a 001 is returned, if not a 000 is returned.
Waveform	WF	Form: WF<Channel><Waveform> Example: "WFATR" Set waveform of a channel. Valid data values for waveform are: SI = Sine RA = Ramp TR = Triangle SQ = Square NS = Noise DC = dc.

```

10 | *****
20 | * HP SERIES 200/300 BASIC language *
30 | * programming example for the *
40 | * standard HP 8904A MULTIFUNCTION *
50 | * SYNTHESIZER. *
60 | *****
70 |
73 OUTPUT 726;"PS" ! Preset HP 8904A.
80 OUTPUT 726;"GM0" ! Goto channel configuration mode.
90 OUTPUT 726;"FC10F" ! Turn output 1 float off.
100 OUTPUT 726;"FRA1000.1HZ" ! Set channel A frequency to 1000.1 Hz.
110 OUTPUT 726;"APA1.25VL" ! Set channel A amplitude to 1.25 V.
120 OUTPUT 726;"PHA90DG" ! Set channel A phase to 90 degrees.
130 OUTPUT 726;"WFARA" ! Set channel A waveform to ramp.
140 END

```

Figure C-1. Sample Program for Configuring Channel A

Table C-2. HP-IB Codes That Can Be Used With Option 01 Instruments (1 of 2).

Function	HP-IB Code	Description
Destination	DE	<p>- Four Channel Operation -</p> <p>Form: DE<Channel><Destination></p> <p>Examples: "DEAOC1", "DEAAM"</p> <p>Set destination of channel. Valid data values for destination are AM, FM, PM, DS, PU, OC1 (OC2 if the instrument is equipped with Option 02) and OF.</p>
Modulation	AM FM PM DS PU	<p>Amplitude Modulation, valid AM terminators are % or PC.</p> <p>Frequency Modulation</p> <p>Phase Modulation, valid PM terminators are DG or RD.</p> <p>DSB Modulation</p> <p>Pulse Modulation</p>
Amplitude	APH	<p>- Signal Sequence Modes -</p> <p>Form: APH<Amplitude Value><Terminator></p> <p>Example: "APH1.999VL"</p> <p>Enter Tone or DTMF amplitude. Amplitude terminators are VL, MV and UV.</p>
Digital Level	DAPH DAPL	<p>Digital Sequence On Level</p> <p>Digital Sequence Off Level</p> <p>Form: DAPH<Amplitude><Terminator></p> <p>Examples: "DAPH4VL", "DAPL-1VL"</p> <p>Digital Sequence Mode amplitude terminators are VL, MV and UV.</p>
Digital Sequence Base	BSB BSO BSH	<p>Select Binary Base</p> <p>Select Octal Base</p> <p>Select Hexadecimal Base</p>
Off Time	STOF	<p>Form: STOF<Time Value><Terminator></p> <p>Example: "STOF1SC"</p> <p>Set Off Time (Tone and DTMF Sequence). Valid terminators are MS and SC.</p>
On Time	STON	<p>Form: STON<Time Value><Terminator></p> <p>Example: "STON9.3MS"</p> <p>Set On Time (Tone and DTMF Sequence). Valid terminators are MS and SC.</p>
Period	SBP	<p>Form: SBP<Time Value><Terminator></p> <p>Example: "SBP9.3MS"</p> <p>Set Period (Digital Sequence Only). Valid terminators are MS and SC.</p>

Table C-2. HP-IB Codes That Can Be Used With Option 01 Instruments (2 of 2).

Function	HP-IB Code	Description
Register Number	HRA	Form: HRA<1 or 2 Digit Address>ET Examples: "HRA2ET" "HRA15ET" Enter Tone or DTMF Register. Addresses 0-15 are valid, Valid terminator is "ET".
Run Mode	RUNC RUNM RUNS STOP	Run Continuously Run Manually Run Single Stop Run
Sequence End	SEQE	Form: SEQE<Sequence End Value>ET Example: "SEQE115ET" Set Sequence End. Valid terminator is ET.
Sequence Index	SEQP	Form: SEQP<Index Value>ET Example: "SEQP37ET" Set Sequence Index. Valid terminator is ET.
Sequence String	WSQ	Form: WSQ<Data String><Terminator> Examples: Tone Sequence = "WSQ01123456789ABCDEF;" DTMF Sequence = "WSQ0123456789ABCD*#;" Digital Sequence Binary Base = "WSQ0101010101010101;" Digital Sequence Octal Base = "WSQ0123456701234567;" Digital Sequence Hex Base = "WSQ0123456789ABCDEF;" Write sequence string. Entry string is terminated with ;, cr/lf, EOI or the etx character.
Tone Frequency	FRH	Form: FRH<Frequency Value><Terminator> Example: "FRH723.5HZ" Enter tone frequency (Tone Sequence Mode only). Valid terminators are HZ and KZ.

```

10  ! *****
20  ! *  HP SERIES 200/300 BASIC language  •
30  ! *  programming example for the      •
40  ! •  HP 8904A MULTIFUNCTION SYNTHESIZER *
50  ! *  OPTION 001: fm stereo composite.  •
60  ! *                               (left channel only) •
70  ! *****
80  !
90  OUTPUT 726;"PS GM0"                ! Preset & go to channel
100                                     ! configuration mode.
110                                     !
120 OUTPUT 726;"DEA0C1 FRA39KZ APA1VL PHA270D6 WFASI" ! Set channel A to
130                                     ! Destination = Output 1,
140                                     ! Freq = 39 kHz, Amplitude =
150                                     ! 1 volt, Phase = 270 degrees
160                                     ! Waveform = Sine.
170                                     !
180 OUTPUT 726;"DEB0C1 FRB37KZ APB1VL PHB90D6 WFBSI" ! Set channel B to
190                                     ! Destination = Output 1,
200                                     ! Freq = 37 kHz, Amplitude =
210                                     ! 1 volt, Phase = 90 degrees,
220                                     ! Waveform = Sine.
230                                     !
240 OUTPUT 726;"DEC0C1 FRC19KZ APC 100MV WFCSI"      ! Set channel C to
250                                     ! Destination = Output 1,
260                                     ! Freq = 19 kHz, Amplitude =
270                                     ! 0.1 volt, Waveform = Sine.
280                                     !
290 OUTPUT 726;"DED0C1 FRD1KZ APD2VL WFDISI"        ! Set channel D to
300                                     ! Destination = Output 1,
310                                     ! Freq = 1 kHz, Amplitude =
320                                     ! 2 volts, Waveform = Sine.
330  END

```

Figure C-2. Sample Program for Configuring Channels A, B, C and D.

```
10  ! *****
20  ! *   HP SERIES 200/300 BASIC language   *
30  ! *   programming example for the       *
40  ! *   HP 8904A MULTIFUNCTION SYNTHESIZER *
50  ! *   OPTION 01: digital sequence.      *
60  ! *****
70  !
80  OUTPUT 726;"PS GM4"                    ! Preset & go to digital
90                                          ! sequence mode.
100
110 OUTPUT 726;"BSB SBP0.5MS DAPH5VL DAPL0.2VL" ! Set sequence base to
120                                          ! Binary, sequence period =
130                                          ! 0.5 ms, on level = 5 volts,
140                                          ! and off level = 0.2 volt.
150
160 OUTPUT 726;"SEQP1ET WSQ000100110111; SEQE12ET" ! Set sequence pointer = 1,
170                                          ! write sequence =
180                                          ! "000100110111", and set
200                                          ! sequence end = 12.
201
210 OUTPUT 726;"RUNC"                      ! Run sequence continuously.
300 END
```

Figure C-3. Sample Program for Configuring a Digital Sequence String

Table C-3. HP-IB Codes That Can Be Used with Option 02 Instruments

Function	HP-IB Code	Description
Destination	DE	Form: DE<Channel><Destination> Examples: "DEAOF" "DEBOC2" Set destination. Valid data values for destination are OC1, OC2 and OF.
Query Port Status	QRE	Form: QRE Example: "QRE" Query present enable status.

```

10  ! *****
20  ! * HP SERIES 200/300 BASIC language *
30  ! * programming example for the *
40  ! * HP 8904A MULTIFUNCTION SYNTHESIZER *
50  ! * Option 02. *
60  ! *****
70  !
80  OUTPUT 726;"PS"           ! Preset HP 8904A.
90  !
100 OUTPUT 726;"GM0"         ! Goto channel configuration mode.
110 !
120 OUTPUT 726;"FRA2KZ APA2VL PHA45DG WFASQ" ! Set channel A frequency =
130 ! 2 kHz, amplitude = 2 volts, phase =
140 ! 45 degress, and waveform = square.
150 !
160 OUTPUT 726;"FRB2KZ APB2VL PHB90DG WFBSQ" ! Set channel B frequency =
170 ! 2 kHz, amplitude = 2 volts, phase =
180 ! 90 degress, and waveform = square.
190 !
200 END

```

Figure C-4. Sample Program for Configuring Output Ports 1 and 2.

Table C-4. HP-IB Codes That Can Be Used with Option 03 Instruments.

Function	HP-IB Code	Description
Amplitude	APH	Form: APH<Amplitude Value><Terminator> Example: "APH2.123VL" Enter Hop Mode amplitude parameter. Valid terminators are VL, MV and UV.
Hop On/Off	AHR	Form: AHR<ON or OF> Example: "AHROF" Amplitude Hop On/Off Control.
Digital Port	DPE	Form: DPE<ON or OF> Example: "DPEOF" Digital Port On/Off Control.
Frequency	FRH	Form: FRH<Frequency Value><Terminator> Example: "FRH723.5HZ" Enter Hop Mode frequency parameter. Valid terminators are HZ and KZ.
Hop On/Off	FHR	Form: FHR<ON or OF> Example: "FHROF" Frequency Hop On/Off Control.
Hop Register	HRA	Form: HRA<1 or 2 Digit Address>ET Example: "HRA9ET" Enter Hop Register address. Addresses 0-15 are valid, valid terminator is ET.
Phase	PHH	Form: PHH<Phase Value><Terminator> Example: "PHH59.3DG" Enter Hop Mode phase. Valid terminators are DG and RD.
Hop On/Off	PHR	Form: PHR<ON or OF> Example: "PHROF" Phase Hop On/Off Control.

```

10      ! *****
20      ! *   HP SERIES 200/300 BASIC language   •
30      ! *   programming example for the       •
40      ! •   HP 8904A MULTIFUNCTION SYNTHESIZER •
50      ! *   OPTION 03: fast hop.             •
60      ! *****
70      !
80      OUTPUT 726;"PS GM0"                    ! Preset & go to channel
90                                             ! configuration mode.
100     !
110     OUTPUT 726;"HRA0ET FRH500HZ APH1VL"    ! Set Hop Ram address = 0,
120                                             ! Hop Freq = 500 Hz, Hop
130                                             ! Amplitude = 1 volt.
140     !
150     OUTPUT 726;"HRA1ET FRH1KZ APH2VL"      ! Set Hop Ram address = 1,
160                                             ! Hop Freq = 1 kHz, Hop
170                                             ! Amplitude = 2 volt.
180     !
190     OUTPUT 726;"HRA2ET FRH1.5KZ APH3VL"    ! Set Hop Ram address = 2,
200                                             ! Hop Freq = 1.5 kHz, Hop
210                                             ! Amplitude = 3 volt.
220     !
230     OUTPUT 726;"HRA3ET FRH2KZ APH4VL"      ! Set Hop Ram address = 3,
240                                             ! Hop Freq = 2 kHz, Hop
250                                             ! Amplitude = 4 volts.
260     !
270     OUTPUT 726;"HRA4ET FRH2.5KZ APH5VL"    ! Set Hop Ram address = 4,
280                                             ! Hop Freq = 2.5 kHz, Hop
290                                             ! Amplitude = 5 volt.
300     !
310     OUTPUT 726;"HRA5ET FRH3KZ APH6VL"      ! Set Hop Ram address = 5,
320                                             ! Hop Freq = 3 kHz, Hop
330                                             ! Amplitude = 6 volts.
340     !
350     OUTPUT 726;"FHRON AHRON"               ! Turn frequency hop on,
360                                             ! and turn amplitude hop on.
370     !
380     FOR I=1 TO 100                          ! Repeat hop seq 100 times.
390         FOR J=0 TO 5                        ! Step from add=0 TO add=5.
400             OUTPUT 726;"HRA",J,"ET"        ! Hop to next address.
410         NEXT J
420     NEXT I
430     END

```

Figure C-5. Sample Program for Hop Mode Operation.

Index

A

address selection 5-9
AM 2-5
 maximum setting, 2-14
 ranges, 2-21
amplitude 1-22
 displayed level, 1-9
AMPTD 1-9
Amptd Hop 5-6

B

backspace 1-8

C

channel 1-15
 summation, 2-16
Channel A
 Channel Configuration Mode, 1-7
 Hop Mode, 5-4, 5-7, 5-11
 modulation, 2-9
 sample HP-IB program, C-4
Channel Config. 1-7
Channel Configuration Mode 1-7
Chassis ground 1-16
 control, 1-6
 Option 02, 4-2
Configuration Options 1-2, 1-23
 Option 01, 2-1, 3-1
 Option 01 with 02, block diagram, 4-12
 Option 02, 4-1
 Option 03, 5-1
copy parameters 3-18

D

deg 1-11
destination 2-7, 2-20
 Help Messages, B-3
DESTN 2-17
DIGITAL PORT 5-8
Digital Sequence 3-14
Digital Sequence Mode
 HP-IB Codes, C-4
 sample HP-IB program, C-8
 specifications, 3-18

DSB 2-5, 2-6, 2-8
 ranges, 2-21
DTMF 3-10
DTMF Sequence 3-10
DTMF Sequence Mode
 HP-IB Codes, C-4
 specifications, 3-18
Dual Output Ports 4-1
 HP-IB Codes, C-9

E

Edit Sequence 3-7
END 3-7
Error Numbers B-1
Exit 1-21

F

Fast Hop 5-8
Float Control 1-6
Floating ground 1-16, 1-21
 cable connections, 1-17
 LEDs, 1-12
 voltage differential, 1-17
FM Stereo Composite Signal 2-22
FM
 ranges, 2-21
Four Channel Operation 2-1
 block diagram, 2-19
 channel combinations, 2-20
 destination, 2-20
 HP-IB Codes, C-4
 modulation, 2-20
 sample HP-IB program, C-7
 Save Register, 2-20
 summation, 2-20
 with Option 02, 4-12
FREQ 1-8
Freq Hop 5-6
frequency ranges 1-8
front panel 1-12

G

ground 1-16

H

HELP B-1
Help Messages B-1
Hop Mode Operation 5-1, 5-3, 5-10
Hop Mode
 address selection, 5-9
 DIGITAL PORT, 5-8
 Fast Hop, 5-8
 HP-IB, 5-11
 HP-IB Codes, C-10
 sample HP-IB program, 5-11, C-11
Hop Register 5-5
HP-IB Codes C-1
 Option 01, C-4
 Option 02, C-9
 Option 03, C-10
HP-IB
 Digital Sequence Mode sample program, C-8
 Fast Hop, 5-9
 Four Channel sample program, C-7
 Help Messages, B-2
 Hop Mode, 5-11
 Hop Mode sample program, C-11
 channel configuration sample program, C-4

INCR SET 1-11
Insert 3-7
Installation A-1

L

LEDs 1-12

M

MAIN 1-21
Manual Dial 3-13
Manual Run 3-8
modulation 2-4, 2-9, 2-20
 AM, 2-5
 ranges, 2-21
 simultaneous, 2-10
 summation of signals, 2-13, 2-15
 with Option 02, 4-8

N

NOISE 1-22

O

Off Level 3-15, 3-18
Off Time 3-5, 3-18
On Level 3-15, 3-18
On Time 3-5, 3-18
Option 01 2-1, 3-1
 HP-IB Codes, C-4
 sample HP-IB program, C-7, C-8
 with 02, block diagram, 4-12
Option 02 4-1
 HP-IB, C-9
 sample HP-IB program, C-9
Option 03 5-1
 HP-IB, C-10
 sample HP-IB program, C-11
Output 1-15
OUTPUT 1-13
Output Port 1-12
 control, 1-13, 1-22
 ground, 1-16
 impedance, 1-13
 LEDs, 1-12
output signal 1-7
 level, 1-9
 summation, 2-16

P

Period 3-15, 3-18
PHASE 1-11
 Hop Mode, 5-7
 Option 02, 4-5
Phase Continuous Sweep 2-25, 3-19
Phase Modulation
 ranges, 2-21
Power A-1
PRESET 1-2, 1-21
Pulse Modulation
 ranges, 2-21

R

RECALL 1-19
Run Mode 3-8

S

SAVE 1-18
Save
 Hop Mode, 5-6
 Signal Sequence Modes, 3-9
Seq Base 3-15
Seq Index 3-6
Sequence Length 3-18
Sequence String 3-6
Signal Sequence Modes 3-1, 3-17
 copy, 3-18
 Help Messages, B-3
 HP-IB Codes, C-4
 specifications, 3-18
simultaneous modulation 2-10
SPECIAL 1-20
Special Functions 1-22
specifications
 Signal Sequence Modes, 3-18
Stereo Phase Test Signal 4-6
summation 2-16, 2-20
 Options 01 and 02 combined, 4-8

T

Tone Configuration 3-4
Tone Register 3-5
Tone Sequence Mode 3-3
 HP-IB Codes, C-4
 specifications, 3-18
Two Output Ports 4-1

V

Variable Duty Cycle Pulse Train 2-24
Variable Phase Signal 4-7
VOR Composite Signal 2-23

W

WAVEFORM 1-10

For information about Hewlett-Packard products and services, telephone the local Hewlett-Packard sales and support office listed in your telephone directory. Or write to the appropriate address listed here.

United States

Hewlett-Packard Company
Microwave and
Communications Group
3000 Hanover Street
Palo Alto, CA 94304

Hewlett-Packard Company
4 Choke Cherry Road
Rockville, MD 20850

Hewlett-Packard Company
5201 Tollview Drive
Rolling Meadows, IL 60008

Hewlett-Packard Company
5161 Lankershim Blvd.
North Hollywood, CA 91601

Hewlett-Packard Company
2000 South Park Place
Atlanta, GA 30339

Canada

Hewlett-Packard (Canada) Ltd.
6877 Goreway Drive
Mississauga, Ontario
Canada, L4V1M8

Europe and Africa

Hewlett-Packard S.A.
P.O. Box 529
1180 AM Amstelveen
The Netherlands

Australasia

Hewlett-Packard Australia Ltd.
31-41 Joseph Street
Blackburn, Victoria 3130
Australia

Japan

Yokagawa-Hewlett-Packard Ltd.
29-21, Takaido-Higashi, 3-Chome
Suginami-ku, Tokyo 168
Japan

Far East Area

Hewlett-Packard Asia Headquarters
47th F, China Resources Bldg.
26 Harbour Road, Wanchai
Hong Kong

Latin America

Hewlett-Packard Company
3495 Deer Creek Road
Palo Alto, CA 94304 U.S.A.

Section 4

PERFORMANCE TESTS

4-1. INTRODUCTION

The procedures in this section test the instrument's electrical performance using the specifications of Table 1-1 as performance standards. All tests are performed without accessing the interior of the instrument.

NOTE

The instrument should be allowed a 10 minute warm-up period prior to beginning the performance tests. Line voltage must be within $\pm 10\%$ of nominal if the results of the performance tests are to be considered valid.

4-2. EQUIPMENT REQUIRED

Equipment required for the performance tests is listed in Table 1-2, *Recommended Test Equipment*. Any equipment that satisfies the critical specifications provided in the table may be substituted for the recommended model(s).

4-3. PERFORMANCE TEST RECORD

Results of the performance tests may be tabulated on the *Performance Test Record* at the end of the procedures. The *Performance Test Record* lists all of the tested specifications and their acceptable limits. The results, recorded at incoming inspection, can be used for comparison in periodic maintenance and troubleshooting and after repairs or adjustments.

4-4. CALIBRATION CYCLE

This instrument requires periodic verification of performance. Depending on the use and environmental conditions, the instrument should be checked using the following performance tests at least once each year.

4-5. BASIC FUNCTIONAL CHECKS

The basic functions of the HP 8904A can be verified by performing the instrument operating demonstrations in Chapter 1 (all instruments) and Chapter 4 (instruments with Option 002) in the HP 8904A *Basic Operation and Application* guide and comparing the output signals with the waveforms shown in the guide. Table 4-1 lists the functions that can be verified using the *Basic Operation and Application* guide.

For Options 005 and 006, refer to the respective Operating Supplement.

Table 4-1. Basic Functional Checks

Reference in <i>Basic Operation and Application Guide</i>	Functions and Operations Verified
Chapter 1	Power up Self check Presence of options User interface Keyboard Display Beeper Signal parameters Waveform Frequency Amplitude Phase Output conditioning Float and ground Filter On and off Store and recall Select special functions
Chapter 4	Second output (Opt 002) Complex signal operations Modulation (Opt 001) Summation (Opt 001)

Performance Test 1

FREQUENCY ACCURACY

Specification

Characteristic	Performance Limits	Conditions
Frequency Internal 10 MHz Time Base Accuracy	±50 ppm	

Description

The frequency of the internal 10 MHz time base is measured directly with a counter.

Equipment

Frequency Counter HP 5314A

NOTE

Counters generally do not have an absolute accuracy specification. Rather the accuracy of the counter is the absolute accuracy of the time standard against which the counter's time base is adjusted, degraded by aging, environmental changes, and the last digit uncertainty. The counter used in this test should be calibrated to within ±5 ppm (that is, 50 Hz out of 10 MHz).

Procedure

1. Connect the frequency counter's input to the Multifunction Synthesizer's rear-panel 10 MHz REF OUT connector.
2. Set the counter to read frequency with at least 10 Hz resolution. The counter should read between 9 999 500 and 10 000 500 Hz (that is, 10 MHz ±500 Hz or ±50 ppm).

10 MHz Time Base Accuracy: 9 999 500 _____ 10 000 500 Hz

Performance Test 2

AC AND DC AMPLITUDE ACCURACY (EXCEPT OUTPUT 1 WITH OPTION 006)

Specification

Characteristic	Performance Limits	Conditions
AC Amplitude		
Range	0 to 10 Vpp	sine wave into 50Ω
Accuracy	1% 3%	>40 mVpp into an open circuit 0.1 Hz to 100 kHz 100 to 600 kHz
DC Amplitude		
Range	0 to ±10V	open circuit
Accuracy	±21 mV or ±2.1% whichever is higher	

Description

DC amplitude accuracy is measured directly with a voltmeter. Each 6 dB attenuation range (down to the range for 10 mV) is measured. To measure ac amplitude accuracy, a dc signal is applied to the high-impedance input of an oscilloscope. This amplitude becomes a reference line on the oscilloscope display. The instrument waveform is then set to a sinusoid with the same peak level as the dc reference.

NOTE

This test does not verify ac amplitude accuracy for Output 1 in instruments with Option 006 (balanced output). Refer to Performance Test 4 for that option. However, if the instrument has Option 002 and 006, perform the dc and ac amplitude accuracy portions of this test for Output 2.

Equipment

Digital Multimeter HP 3478A
 Oscilloscope HP 1740A or Tektronix 2235

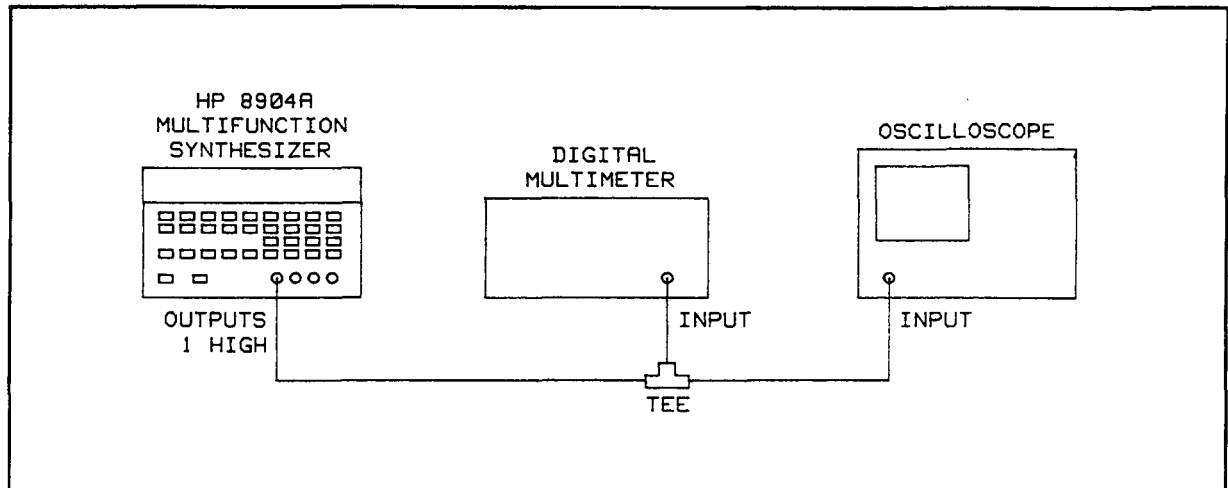

Figure 4-1. AC and DC Amplitude Accuracy Performance Test Setup

Procedure

DC Amplitude Accuracy—Output 1

NOTE

If the instrument has an Option 002 and 006 combination, skip to step 6.

1. On the Multifunction Synthesizer, press SHIFT PRESET. After the instrument presets, key in
 f1 (Channel Config.)
 NEXT
 SHIFT FLOAT 1 OFF
 WAVE FORM \equiv
2. Connect the Multifunction Synthesizer, OUTPUTS 1 HIGH output and the digital multimeter input both to the oscilloscope's dc coupled high-impedance, vertical input using a tee. Refer to Figure 4-1.
3. Switch the digital multimeter to measure dc volts. On the Multifunction Synthesizer, set the dc amplitude as listed in the following table. For each setting, the amplitude as read on the digital multimeter should be within the limits shown.

NOTE

If the measurements are slightly out of limits, performing Adjustment 1, Output Gain and Offset may bring the instrument within specifications.

Amplitude Setting	Voltage Reading Limits		
	Lower	Actual	Upper
10 V	9.794 Vdc	_____	10.21 Vdc
5.01 V	4.907 Vdc	_____	5.115 Vdc
5 V	4.897 Vdc	_____	5.105 Vdc
2.5 V	2.449 Vdc	_____	2.553 Vdc
1.25 V	1.224 Vdc	_____	1.276 Vdc
625 mV	604 mVdc	_____	646 mVdc
312 mV	291 mVdc	_____	333 mVdc
156.2 mV	135.2 mVdc	_____	177.2 mVdc
78.1 mV	57.1 mVdc	_____	99.1 mVdc
39.0 mV	18.0 mVdc	_____	60.0 mVdc
19.5 mV	-1.5 mVdc	_____	40.5 mVdc
10.0 mV	-11.0 mVdc	_____	31.0 mVdc
-10 V	-10.21 Vdc	_____	-9.794 Vdc
-5.01 V	-5.115 Vdc	_____	-4.907 Vdc
-5 V	-5.105 Vdc	_____	-4.897 Vdc
-2.5 V	-2.553 Vdc	_____	-2.449 Vdc
-1.25 V	-1.276 Vdc	_____	-1.224 Vdc
-625 mV	-646 mVdc	_____	-604 mVdc
-312 mV	-333 mVdc	_____	-291 mVdc
-156.2 mV	-177.2 mVdc	_____	-135.2 mVdc
-78.1 mV	-99.1 mVdc	_____	-57.1 mVdc
-39.0 mV	-60.0 mVdc	_____	-18.0 mVdc
-19.5 mV	-40.5 mVdc	_____	1.5 mVdc
-10.0 mV	-31.0 mVdc	_____	11.0 mVdc

AC Amplitude Accuracy-Output 1

- On the Multifunction Synthesizer, key in AMPTD 8 V. Set the oscilloscope's input impedance to 50 ohms or terminate the input in 50 ohms using a tee. Set the oscilloscope's vertical sensitivity to 1 V/division. Adjust the vertical position of the dc trace to coincide with the second graticule line from the top of the screen.
- On the Multifunction Synthesizer, key in WAVE FORM \sim . Set the frequency indicated in the following table. (The amplitude is to remain the same as set in step 4, that is, 8V.) For each setting, adjust the oscilloscope's time scale to obtain a useable display and note the peak amplitude relative to the second graticule line. The peak amplitude should be within the limits listed in the table.

NOTE

Drift in the oscilloscope may require periodically checking the dc 4V reference line. To do this simply set the Multifunction Synthesizer waveform back to dc, check the dc voltage on the digital multimeter, and readjust the vertical position of the oscilloscope.

If it is difficult to locate the position of the limits on the display, simply set the amplitude increment of the Multifunction Synthesizer to 0.08V and increment the amplitude down once then up once. This increment causes a 0.08 division (1%) level shift.

To improve the display resolution, it is possible to use a more sensitive input range or vertical magnification (if that feature is available). However, care must be taken to assure that the 8 Vpp signal does not overdrive the oscilloscope's input amplifier.

Frequency (Hz)	Peak Difference Limits (divisions)		
	Lower	Actual	Upper
0.1	-0.08	_____	0.08
1 000	-0.08	_____	0.08
100 000	-0.08	_____	0.08
600 000	-0.24	_____	0.24

NOTE

This concludes the test if the instrument does not have Option 002.

DC Amplitude Accuracy-Output 2

6. On the Multifunction Synthesizer, press SHIFT PRESET. After the instrument presets, key in
 f1 (Channel Config.)
 NEXT NEXT
 SHIFT FLOAT 2 OFF
 WAVE FORM ---
7. Connect the Multifunction Synthesizer, OUTPUTS 2 HIGH output and the digital multimeter input both to the oscilloscope's dc coupled high-impedance, vertical input using a tee. Refer to Figure 4-1.
8. Switch the digital multimeter to measure dc volts. On the Multifunction Synthesizer, set the dc amplitude as listed in the following table. For each setting, the amplitude as read on the digital multimeter should be within the limits shown.

NOTE

If the measurements are slightly out of limits, performing Adjustment 1, Output Gain and Offset may bring the instrument within specifications.

Amplitude Setting	Voltage Reading Limits		
	Lower	Actual	Upper
10 V	9.794 Vdc	_____	10.21 Vdc
5.01 V	4.907 Vdc	_____	5.115 Vdc
5 V	4.897 Vdc	_____	5.105 Vdc
2.5 V	2.449 Vdc	_____	2.553 Vdc
1.25 V	1.224 Vdc	_____	1.276 Vdc
625 mV	604 mVdc	_____	646 mVdc
312 mV	291 mVdc	_____	333 mVdc
156.2 mV	135.2 mVdc	_____	177.2 mVdc
78.1 mV	57.1 mVdc	_____	99.1 mVdc
39.0 mV	18.0 mVdc	_____	60.0 mVdc
19.5 mV	-1.5 mVdc	_____	40.5 mVdc
10.0 mV	-11.0 mVdc	_____	31.0 mVdc
-10 V	-10.21 Vdc	_____	-9.794 Vdc
-5.01 V	-5.115 Vdc	_____	-4.907 Vdc
-5 V	-5.105 Vdc	_____	-4.897 Vdc
-2.5 V	-2.553 Vdc	_____	-2.449 Vdc
-1.25 V	-1.276 Vdc	_____	-1.224 Vdc
-625 mV	-646 mVdc	_____	-604 mVdc
-312 mV	-333 mVdc	_____	-291 mVdc
-156.2 mV	-177.2 mVdc	_____	-135.2 mVdc
-78.1 mV	-99.1 mVdc	_____	-57.1 mVdc
-39.0 mV	-60.0 mVdc	_____	-18.0 mVdc
-19.5 mV	-40.5 mVdc	_____	1.5 mVdc
-10.0 mV	-31.0 mVdc	_____	11.0 mVdc

AC Amplitude Accuracy-Output 2

9. On the Multifunction Synthesizer, key in AMPTD 8 V. Set the oscilloscope's vertical sensitivity to 2 V/division. Adjust the vertical position of the dc trace to coincide with the second graticule line from the top of the screen.
10. On the Multifunction Synthesizer, key in WAVE FORM \sim . Set the frequency indicated in the following table. (The amplitude is to remain the same as set in step 9, that is, 8V.) For each setting, adjust the oscilloscope's time scale to obtain a useable display and note the peak amplitude relative to the second graticule line. The peak amplitude should be within the limits listed in the table.

NOTE

Refer to the notes following step 5.

Frequency (Hz)	Peak Difference Limits (divisions)		
	Lower	Actual	Upper
0.1	-0.08	_____	0.08
1 000	-0.08	_____	0.08
100 000	-0.08	_____	0.08
600 000	-0.24	_____	0.24

Performance Test 3

AC AMPLITUDE FLATNESS (EXCEPT OUTPUT 1 WITH OPTION 006)

Specification

Characteristic	Performance Limits	Conditions
AC Amplitude Flatness	$\pm 0.1\%$ (± 0.009 dB) $\pm 1\%$ (± 0.09 dB)	sine wave >630 mVpp into 50 Ω ; 0.1 Hz to 100 kHz >630 mVpp into 50 Ω ; 100 to 600 kHz

Description

The output of the Multifunction Synthesizer is connected directly to a thermal converter. The output of the converter, which is a dc voltage proportional to the rms input, is read on a digital voltmeter. A reference is determined with the Multifunction Synthesizer set to 1 kHz at 0.7 V_{rms} into 50 Ω . The frequency is then changed and the deviation from the reference noted.

This test relies on the flat frequency response of the converter. The amount of deviation from the reference level at various frequencies is determined by incrementing the Multifunction Synthesizer's amplitude until the reading is the same as for the reference then noting the total level change required.

NOTE

This test does not verify ac amplitude flatness for Output 1 in instruments with Option 006 (balanced output). Refer to Performance Test 4 for that option. However, if the instrument has Option 002 and 006, perform the portion of this test for Output 2.

Equipment

Digital Multimeter HP 3478A
 Thermal Converter HP 11050A or Ballentine Labs 1395A-1

CAUTION

The thermal converter is susceptible to burnout if more than 1 V_{rms} is applied to its input. Be careful when changing the frequency of the Multifunction Synthesizer that the amplitude does not inadvertently exceed 1 V_{rms} (a displayed setting of 2.8 V on the Multifunction Synthesizer).

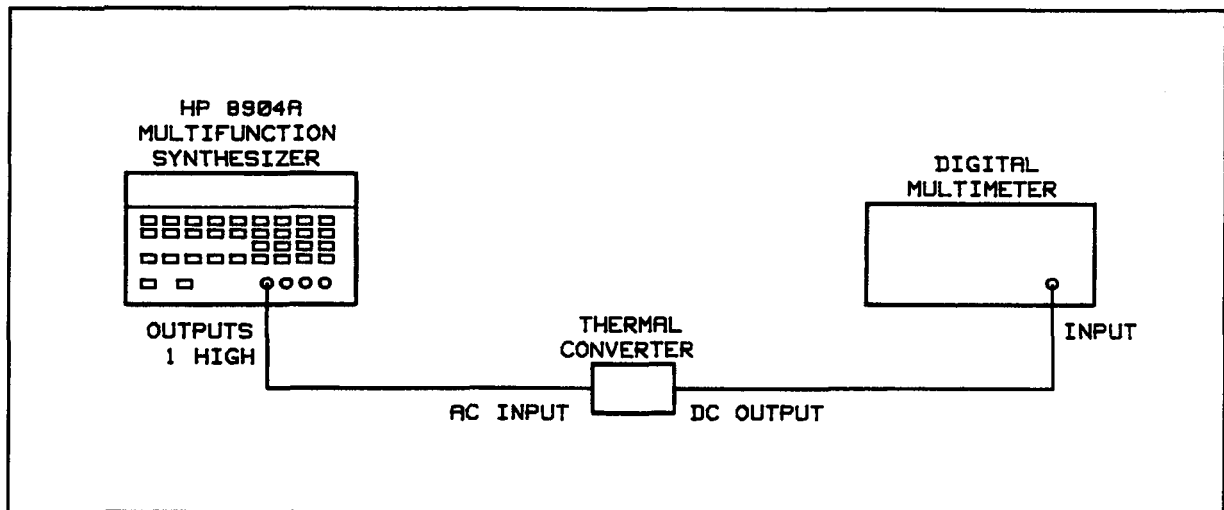

Figure 4-2. AC Amplitude Flatness Performance Test Setup

Procedure

Output 1

NOTE

If the instrument has an Option 002 and 006 combination, skip to step 7.

1. On the Multifunction Synthesizer, press SHIFT PRESET. After the instrument presets, key in
 SHIFT SPECIAL
 NEXT
 f2 (Status) ON
 NEXT NEXT NEXT
 f2 (Status) ON
 f4 (Exit)
 f1 (Channel Config.)
 NEXT
 SHIFT FLOAT 1 OFF
 AMPTD 2 V
 INCR SET 2 mV
2. Connect the ac input of the thermal converter to the Multifunction Synthesizer's OUTPUTS 1 HIGH output. Connect the dc output of the thermal converter to the input of the voltmeter. Refer to Figure 4-2.
3. Switch the voltmeter to measure dc volts on a 10 mV range. Read the voltage and record it for future reference. (The voltage should be about +3.7 mVdc for the HP 11050A Thermal Converter.)

1 kHz Reference: _____ mVdc

NOTE

Perform step 4 quickly to minimize the effect of thermal drift on the thermal converter. Check the level at 1 kHz before setting the next frequency if drift is suspected.

4. On the Multifunction Synthesizer, set the frequency as indicated in the following table. For each setting, perform the following steps:
 - a. On the Multifunction Synthesizer, key in AMPTD 2 V again.
 - b. Note the dc voltage on the voltmeter.
 - c. On the Multifunction Synthesizer, press the \uparrow or \downarrow keys as needed to bring the dc voltage to the level noted in step 3. Keep track of the number of increments required to do this. Consider each upward increment as positive and each downward increment as negative.

NOTE

The Multifunction Synthesizer's display usually will not show the amplitude with the resolution needed to see the effect of the amplitude incrementing. This is why it is important to keep track of the total number of increments.

Frequency (Hz)	Number of Increments
20	_____
100	_____
1 000	0.0
10 000	_____
50 000	_____
100 000	_____
200 000	_____
600 000	_____

5. For frequencies of 20 Hz to 100 kHz in the table of step 4, compute the largest difference in number of increments. The absolute value of this difference should be 2 increments or less.

Flatness from 20 Hz to 100 kHz: _____ 2 increments

6. For frequencies of 100 to 600 kHz in the table of step 4, compute the largest difference in number of increments. The absolute value of this difference should be 20 increments or less.

Flatness from 100 to 600 kHz: _____ 20 increments

NOTE

If the measurements are slightly out of limits (especially between 100 and 600 kHz), performing Adjustment 3, Sharp Cutoff Low-Pass Filter and Adjustment 4, Sine X/X Compensation may bring the instrument within specifications.

This concludes the test if the instrument does not have Option 002.

Output 2

7. On the Multifunction Synthesizer, press SHIFT PRESET. After the instrument presets, key in

```
SHIFT SPECIAL
NEXT
f2 (Status) ON
NEXT NEXT NEXT
f2 (Status) ON
f4 (Exit)

f1 (Channel Config.)
NEXT NEXT
SHIFT FLOAT 2 OFF
AMPTD 2 V
INCR SET 2 mV
```

8. Connect the ac input of the thermal converter to the Multifunction Synthesizer's OUTPUTS 2 HIGH output. Connect the dc output of the thermal converter to the input of the voltmeter. Refer to Figure 4-2.

9. Read the voltage and record it for future reference (as was done in step 3.)

1 kHz Reference: _____ mVdc

10. On the Multifunction Synthesizer, set the frequency as indicated in the following table (as was done in step 4). For each setting, perform the following steps:

- a. On the Multifunction Synthesizer, key in AMPTD 2 V again.
- b. Note the dc voltage on the voltmeter.
- c. On the Multifunction Synthesizer, press the \uparrow or \downarrow keys as needed to bring the dc voltage to the level noted in step 9. Keep track of the number of increments required to do this.

Frequency (Hz)	Number of Increments
20	_____
100	_____
1 000	0.0
10 000	_____
50 000	_____
100 000	_____
200 000	_____
600 000	_____

11. For frequencies of 20 Hz to 100 kHz in the table of step 10, compute the largest difference in number of increments. The absolute value of this difference should be 2 increments or less.

Flatness from 20 Hz to 100 kHz: _____ 2 increments

12. For frequencies of 100 to 600 kHz in the table of step 10, compute the largest difference in number of increments. The absolute value of this difference should be 20 increments or less.

Flatness from 100 to 600 kHz: _____ 20 increments

Performance Test 4

AC AMPLITUDE ACCURACY AND FLATNESS (OUTPUT 1 WITH OPTION 006)

Specification

Characteristic	Performance Limits	Conditions
AC Amplitude		Option 006; sine wave
Range	0 to 20 Vrms 0 to 10 Vrms 0 to 4 Vrms 0 to 1.5 Vrms	into open circuit into 600 Ω into 150 Ω into 50 Ω
Accuracy	6% (0.5 dB) 12% (1.0 dB)	>40 mVrms into a balanced 600 Ω load 30 Hz to 20 kHz 30 Hz to 100 kHz
Flatness	-0.15 to +0.15 dB -0.75 to +0.15 dB	>40 mVrms into a balanced 600 Ω load; 1 kHz reference 30 Hz to 20 kHz 30 Hz to 100 kHz

Description

AC amplitude accuracy and flatness for Output 1 of instruments with Option 006 are measured directly with a voltmeter.

NOTE

This test verifies ac amplitude accuracy and flatness for Output 1 in instruments with Option 006. If the instrument has Option 002 (a second output), also perform Performance Tests 2 and 3.

Equipment

Digital Multimeter HP 3478A
 Feedthrough Termination, 600 Ω HP 11095A
 Adapter, BNC to Dual Banana Plug (2 required) HP 1251-2277

Procedure

AC Amplitude Accuracy

1. On the Multifunction Synthesizer, press SHIFT PRESET. After the instrument presets, key in
 f1 (Channel Config.)
 NEXT
 SHIFT FLOAT 1 ON
2. Connect the Multifunction Synthesizer OUTPUTS 1 HIGH and LOW outputs to the multimeter's high-impedance floating inputs through a 600Ω feedthrough termination. Use two BNC-to-dual-banana plug adapters and two BNC-to-single-banana plug adapters (supplied with the Multifunction Synthesizer) as necessary to maintain a floating output.
3. Set the digital multimeter to read ac volts.
4. Set the Multifunction Synthesizer's amplitude and frequency as indicated in the following table. For each setting, the amplitude as read on the digital multimeter should be within the limits shown.

Multifunction Synthesizer Settings		Voltage Reading Limits (Vrms)		
Frequency (Hz)	Amplitude (Vrms)	Lower	Actual	Upper
30	10	9.4	_____	10.6
100	10	9.4	_____	10.6
1 000	10	9.4	_____	10.6
10 000	10	9.4	_____	10.6
20 000	10	9.4	_____	10.6
100 000	10	8.8	_____	11.2
30	1	0.94	_____	1.06
100	1	0.94	_____	1.06
1 000	1	0.94	_____	1.06
10 000	1	0.94	_____	1.06
20 000	1	0.94	_____	1.06
100 000	1	0.88	_____	1.12
30	0.1	0.094	_____	0.106
100	0.1	0.094	_____	0.106
1 000	0.1	0.094	_____	0.106
10 000	0.1	0.094	_____	0.106
20 000	0.1	0.094	_____	0.106
100 000	0.1	0.088	_____	0.112

AC Amplitude Flatness

5. On the Multifunction Synthesizer, key in
 FREQ 1 kHz
 AMPTD 10 V
 INCR SET 10 mV

6. Fine adjust the Multifunction Synthesizer's amplitude using the \Downarrow and \Uparrow keys until the voltage reads between 9.99 and 10.01 Vac.
7. Set the Multifunction Synthesizer's frequency as indicated in the following table. For each setting, the amplitude as read on the digital multimeter should be within the limits shown.

Frequency Setting (Hz)	Voltage Reading Limits (Vrms)		
	Lower	Actual	Upper
30	9.83	_____	10.17
100	9.83	_____	10.17
10 000	9.83	_____	10.17
20 000	9.83	_____	10.17
100 000	9.17	_____	10.17

Performance Test 5

SPECTRAL PURITY (EXCEPT OUTPUT 1 WITH OPTION 006)

Specification

Characteristic	Performance Limits	Conditions
Spectral Purity		sine wave; including spurs; amplitude >50 mVrms into 50Ω
THD+N	-63 dBc rms (0.07%) -63 dBc rms (0.07%) -55 dBc rms (0.18%)	20 Hz to 7.5 kHz; 30 kHz BW 7.5 to 20 kHz; 80 kHz BW 20 to 100 kHz; 750 kHz BW

Description

The total harmonic distortion plus noise (THD+N) is measured directly by a distortion analyzer. The distortion analyzer removes the fundamental with a notch filter and measures the signal out of the notch filter and the total input signal into the notch filter. THD+N is the ratio of these two voltages.

NOTE

This test does not verify spectral purity for Output 1 in instruments with Option 006 (balanced output). Refer to Performance Test 6 for that option. However, if the instrument has Option 002 and 006, perform the portion of this test for Output 2.

Equipment

Audio Analyzer HP 8903B

Procedure

Output 1

NOTE

If the instrument has an Option 002 and 006 combination, skip to step 4.

1. On the Multifunction Synthesizer, press SHIFT PRESET. After the instrument presets, key in
 f1 (Channel Config.)
 NEXT
 SHIFT FLOAT 1 OFF
 AMPTD 10 V
2. Connect the OUTPUTS 1 HIGH output to the audio analyzer's (non-floating) input. Terminate the audio analyzer's input in 50Ω using a tee.

- Set the audio analyzer to measure distortion in dB. On the Multifunction Synthesizer, set the amplitude and frequency as listed in the following table. Also, set the low-pass filter on the audio analyzer as listed. For each setting, the distortion read on the audio analyzer should be within the limits shown.

NOTE

Failure to pass this test may be due to ground loops in the test setup. Try floating the Multifunction Synthesizer (that is, key in SHIFT FLOAT 1 ON), set the audio analyzer's input to float, and connect a pair of cables (twisting them a few times) between the high connectors and the low connectors. Place the 50Ω load at the audio analyzer's input.

This concludes the test if the instrument does not have Option 002.

Analyzer Low-Pass Filter (kHz)	Multifunction Synthesizer Settings		Distortion Limits (dB)	
	Frequency (Hz)	Amplitude (V)	Actual	Upper
30	20	10	_____	-63
30	7 500	10	_____	-63
80	7 500	10	_____	-63
80	20 000	10	_____	-63
750 ⁽¹⁾	20 000	10	_____	-55
750 ⁽¹⁾	100 000	10	_____	-55
30	20	0.14	_____	-63
30	7 500	0.14	_____	-63
80	7 500	0.14	_____	-63
80	20 000	0.14	_____	-63
750 ⁽¹⁾	20 000	0.14	_____	-55
750 ⁽¹⁾	100 000	0.14	_____	-55

(1) On an HP 8903B a 750 kHz low-pass filter is selected when the other low-pass filters are off.

Output 2

- On the Multifunction Synthesizer, press SHIFT PRESET. After the instrument presets, key in
f1 (Channel Config.)
NEXT NEXT
SHIFT FLOAT 2 OFF
AMPTD 10 V
- Connect the OUTPUTS 2 HIGH output to the audio analyzer's (non-floating) input. Terminate the audio analyzer's input in 50Ω using a tee.
- Set the audio analyzer to measure distortion in dB. On the Multifunction Synthesizer, set the amplitude and frequency as listed in the following table (as was done in step 3). Also, set the low-pass filter on the audio analyzer as listed. For each setting, the distortion read on the audio analyzer should be within the limits shown.

Analyzer Low-Pass Filter (kHz)	Multifunction Synthesizer Settings		Distortion Limits (dB)	
	Frequency (Hz)	Amplitude (V)	Actual	Upper
30	20	10	_____	-63
30	7 500	10	_____	-63
80	7 500	10	_____	-63
80	20 000	10	_____	-63
750 ⁽¹⁾	20 000	10	_____	-55
750 ⁽¹⁾	100 000	10	_____	-55
30	20	0.14	_____	-63
30	7 500	0.14	_____	-63
80	7 500	0.14	_____	-63
80	20 000	0.14	_____	-63
750 ⁽¹⁾	20 000	0.14	_____	-55
750 ⁽¹⁾	100 000	0.14	_____	-55

(1) On an HP 8903B a 750 kHz low-pass filter is selected when the other low-pass filters are off.

Performance Test 6

SPECTRAL PURITY (OUTPUT 1 WITH OPTION 006)

Specification

Characteristic	Performance Limits	Conditions
Spectral Purity		Option 006; sine wave; including spurs; amplitude 0.14 to 10 Vrms into a balanced 600Ω load
THD+N	-46 dBc (0.56%) -60 dBc (0.10%) -63 dBc (0.07%) -55 dBc (0.18%)	30 to 300 Hz; 30 kHz BW; amplitude ;1 Vrms 0.3 to 7.5 kHz; 30 kHz BW 7.5 to 20 kHz; 80 kHz BW 20 to 100 kHz; 750 kHz BW

Description

The total harmonic distortion plus noise (THD+N) is measured directly by a distortion analyzer. The distortion analyzer removes the fundamental with a notch filter and measures the signal out of the notch filter and the total input signal into the notch filter. THD+N is the ratio of these two voltages.

NOTE

This test verifies the spectral purity of Output 1 in instruments with Option 006. If the instrument has Option 002 (a second output), also perform Performance Test 5.

Equipment

Audio Analyzer HP 8903B
 Feedthrough Termination, 600Ω HP 11095A
 Adapter, BNC to Dual Banana Plug (2 required) HP 1251-2277

Procedure

1. On the Multifunction Synthesizer, press SHIFT PRESET. After the instrument presets, key in
 f1 (Channel Config.)
 NEXT
 SHIFT FLOAT 1 ON
 AMPTD 10 V
2. Connect the Multifunction Synthesizer OUTPUTS 1 HIGH and LOW outputs to the audio analyzer's floating inputs through a 600Ω feedthrough termination. Use two BNC-to-dual-banana plug adapters and two BNC-to-single-banana plug adapters (supplied with the Multifunction Synthesizer) as necessary to maintain a floating output. (The HP 8903B will also require two BNC-to-single-banana plug adapters.)

- Set the audio analyzer to measure distortion in dB. On the Multifunction Synthesizer, set the amplitude and frequency as listed in the following table. Also, set the low-pass filter on the audio analyzer as listed. For each setting, the distortion read on the audio analyzer should be within the limits shown.

Analyzer Low-Pass Filter (kHz)	Multifunction Synthesizer Settings		Distortion Limits (dB)	
	Frequency (Hz)	Amplitude (Vrms)	Actual	Upper
30	300	10	_____	-60
80	7 500	10	_____	-63
80	20 000	10	_____	-63
750 ⁽¹⁾	20 000	10	_____	-55
750 ⁽¹⁾	100 000	10	_____	-55
30	30	1	_____	-46
30	300	1	_____	-60
30	7 500	1	_____	-63
80	7 500	1	_____	-63
80	20 000	1	_____	-63
750 ⁽¹⁾	20 000	1	_____	-55
750 ⁽¹⁾	100 000	1	_____	-55
30	20	0.14	_____	-63
30	7 500	0.14	_____	-63
80	7 500	0.14	_____	-63
80	20 000	0.14	_____	-63
750 ⁽¹⁾	20 000	0.14	_____	-55
750 ⁽¹⁾	100 000	0.14	_____	-55

⁽¹⁾ On an HP 8903B a 750 kHz low-pass filter is selected when the other low-pass filters are off.

Performance Test 7

PHASE ACCURACY (USING AN OSCILLOSCOPE)

Specification

Characteristic	Performance Limits	Conditions
Phase		sine wave
Range	0 to 359.9 deg	
Accuracy	± 0.05 deg	relative to 0 deg for a fixed frequency; 0.1 Hz to 100 kHz

Description

The timebase reference of a synthesized signal generator is slaved to the timebase reference of the Multifunction Synthesizer. The frequency of the reference synthesizer is set to exactly 10 times the frequency of the Multifunction Synthesizer. The synthesizer outputs are connected to the X and Y inputs of an oscilloscope. The phase of the reference synthesizer is adjusted so that the Lissajous pattern generated on the oscilloscope display aligns with itself. The phase of the Multichannel Synthesizer is then stepped in 18 deg increments and the alignment of the pattern is checked for each step.

NOTE

Phase accuracy for Output 1 in instruments with Option 006 (balanced output) is not specified. However, if the instrument has Option 002 and 006, perform the portion of this test for Output 2.

An alternate test for verifying phase accuracy is given in Performance Test 8—Phase Accuracy (Using a Time Interval Counter).

Equipment

Oscilloscope HP 1740A or Tektronix 2235
Synthesized Signal Generator HP 3325A

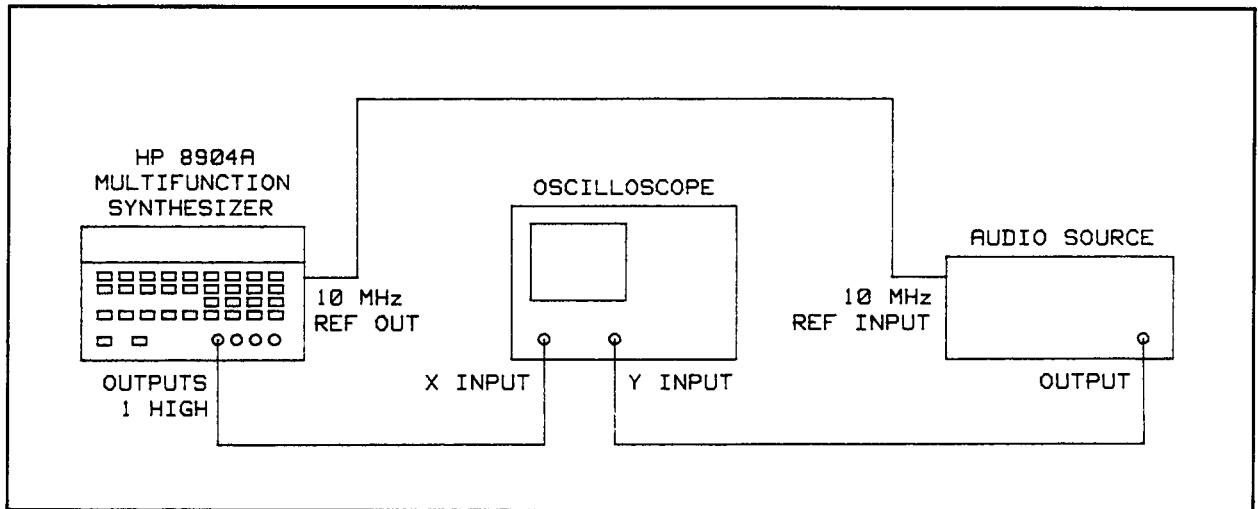

Figure 4-3. Phase Accuracy Performance Test Setup

Procedure

Output 1

NOTE

If the instrument has an Option 002 and 006 combination, skip to step 6.

1. Set up the equipment as follows. Refer to Figure 4-3.
 - a. Connect the Multifunction Synthesizer's rear-panel 10 MHz REF OUT to the reference synthesizer's 10 MHz reference input and set the reference synthesizer to accept an external reference.

NOTE

Alternatively, the Multifunction Synthesizer may be connected to accept a 10 MHz reference from the reference synthesizer if needed.

- b. Connect the Multifunction Synthesizer OUTPUTS 1 HIGH output to the oscilloscope's dc coupled, X input. Switch the oscilloscope's input impedance to 50 Ω or terminate the input in 50 Ω using a tee.
 - c. Connect the reference synthesizer's output to the oscilloscope's dc coupled, Y input. Switch the oscilloscope's input impedance to 50 Ω or terminate the input in 50 Ω using a tee.
2. On the Multifunction Synthesizer, press SHIFT PRESET. After the instrument presets, key in

```
f1 (Channel Config.)
NEXT
SHIFT FLOAT 1 OFF
FREQ 100 kHz
AMPTD 1 V
PHASE INCR SET 18 deg
```

3. Set the reference synthesizer's frequency to exactly 1 MHz and its amplitude to 0.7 Vrms (1 Vpk, 10 dBm) into 50Ω.
4. Switch the oscilloscope to the X vs. Y display mode. Set the vertical sensitivity of each input to 100 mV per division.
5. Set the frequency of the two synthesizers as indicated in the following table. For each setting perform the following steps.
 - a. Adjust the phase of the reference synthesizer until the "front" and "back" traces of the Lissajous pattern coincide.
 - b. On the Multifunction Synthesizer, press PHASE, then press the \uparrow key 19 times and observe the alignment of the waves of the resulting Lissajous pattern each time. The worst-case misalignment should be within the limits indicated in the table.

NOTE

To determine the alignment limits, momentarily set the phase increment of the Multifunction Synthesizer to 0.1 deg, press \uparrow , observe the misalignment (which equals 0.1 deg), then press \downarrow . (0.1 deg is the instrument's smallest phase increment; 0.05 deg must be extrapolated from the observed 0.1 deg increment.) Remember to set the phase increment back to 18 deg after this check.

The vertical gain of the X-axis input can be set to 50 mV per division to increase the alignment resolution if the signal does not overdrive the oscilloscope's input amplifier. Also, perform this test quickly to reduce the effects of phase drift in the oscilloscope's amplifiers.

Reference Synthesizer Frequency (Hz)	Multifunction Synthesizer Frequency (Hz)	Misalignment Limits (deg)		
		Lower	Actual	Upper
1 000 000	100 000	-0.05	_____	0.05
500 000	50 000	-0.05	_____	0.05
200 000	20 000	-0.05	_____	0.05
10 000	1 000	-0.05	_____	0.05
1 000	100	-0.05	_____	0.05

NOTE

Phase accuracy can be measured at lower frequencies (down to the specified 0.1 Hz) if the oscilloscope has storage capabilities. At lower frequencies the drift in the oscilloscope's vertical amplifiers may become significant.

This concludes the test if the instrument does not have Option 002.

Output 2

6. Set up the equipment as in step 1 except connect the Multifunction Synthesizer OUTPUTS 2 HIGH output to the oscilloscope's dc coupled, X input. Refer to Figure 4-3.
7. On the Multifunction Synthesizer, press SHIFT PRESET. After the instrument presets, key in
 f1 (Channel Config.)
 NEXT NEXT
 SHIFT FLOAT 2 OFF
 FREQ 100 kHz
 AMPTD 1 V
 PHASE INCR SET 18 deg
8. Set the reference synthesizer's frequency to exactly 1 MHz. (The amplitude remains at 0.7 Vrms.)
9. Set the frequency of the two synthesizers as indicated in the following table (as was done in step 5). For each setting perform the following steps.
 - a. Adjust the phase of the reference synthesizer until the "front" and "back" traces of the Lissajous pattern coincide.
 - b. On the Multifunction Synthesizer, press PHASE, then press the \uparrow key 19 times and observe the alignment of the waves of the resulting Lissajous pattern each time. The worst-case misalignment should be within the limits indicated in the table.

NOTE

Refer to the note following step 5b.

Reference Synthesizer Frequency (Hz)	Multifunction Synthesizer Frequency (Hz)	Misalignment Limits (deg)		
		Lower	Actual	Upper
1 000 000	100 000	-0.05	_____	0.05
500 000	50 000	-0.05	_____	0.05
200 000	20 000	-0.05	_____	0.05
10 000	1 000	-0.05	_____	0.05
1 000	100	-0.05	_____	0.05

Performance Test 8

PHASE ACCURACY (USING A TIME INTERVAL COUNTER)

Specification

Characteristic	Performance Limits	Conditions
Phase		sine wave
Range	0 to 359.9 deg	
Accuracy	± 0.05 deg	relative to 0 deg for a fixed frequency; 0.1 Hz to 100 kHz

Description

The timebase reference of a reference multifunction synthesizer is slaved to the timebase reference of the test Multifunction Synthesizer. The synthesizers are set to the same frequency and the outputs are connected to the start and stop inputs of a time interval counter. For convenience, the initial phase offset (that is, the time interval) between the two signals is subtracted out (by the time interval counter). The phase of the test multifunction synthesizer is set to several offsets and the time interval measured to determine the actual phase shift.

NOTE

Phase accuracy for Output 1 in instruments with Option 006 (balanced output) is not specified. However, if the instrument has Option 002 and 006, perform the portion of this test for Option 002.

An alternate test for verifying phase accuracy is given in Performance Test 7-Phase Accuracy (Using an Oscilloscope).

Equipment

Multifunction Synthesizer (Reference) HP 8904A
 Time Interval Counter HP 5370B

Procedure

Output 1

NOTE

If the instrument has an Option 002 and 006 combination, skip to step 5.

1. Set up the equipment as follows. Refer to Figure 4-4.
 - a. Connect the test Multifunction Synthesizer's rear-panel 10 MHz REF OUT to the reference multifunction synthesizer's 10 MHz reference input. (This slaves the two synthesizers to a common reference.)

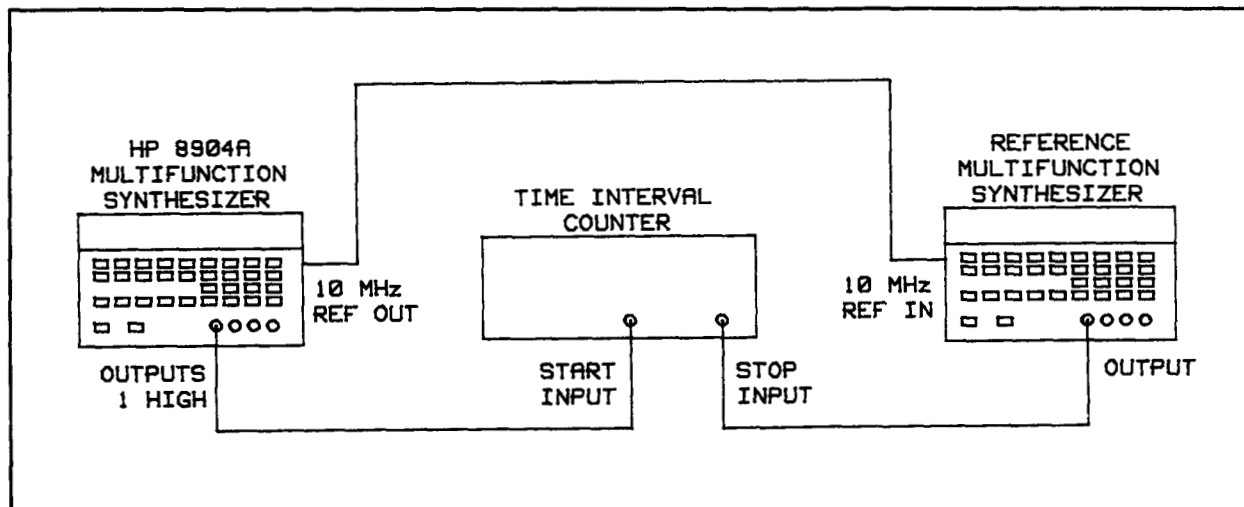

Figure 4-4. Phase Accuracy Performance Test Setup

- b. Connect the test Multifunction Synthesizer OUTPUTS 1 HIGH output to the start input of the time interval counter.
 - c. Connect the reference multifunction synthesizer's output to the stop input of the counter.
2. On both Multifunction Synthesizers, press SHIFT PRESET. After the instruments preset, key in

```
f1 (Channel Config.)
NEXT
SHIFT FLOAT 1 OFF
FREQ 100 kHz
AMPTD 5 V
```
3. Set the time interval counter as follows. (Input settings apply to both the start and stop inputs.)
 - a. Set the measurement function to time interval.
 - b. Set the statistics function to mean and clear the reference.
 - c. Set the sample size to 1000.
 - d. Set the display rate to maximum.
 - e. Set the input impedance to 50Ω , input attenuation to $\div 1$, and input coupling to DC.
 - f. Set the trigger slope for a positive going edge.
 - g. Adjust the input trigger level to 0V.
4. Set the frequency of both Multifunction Synthesizers as indicated in the following table. For each setting, perform the following steps.
 - a. On the test Multifunction Synthesizer, key in PHASE 0 deg.
 - b. Press the set reference key on the counter (that is, press the set reference key of the statistics functions).
 - c. On the test Multifunction Synthesizer, key in the phase as indicated in the table. The time interval on the counter display should be within the limits given in the table.

NOTE

If the time interval is negative, set the phase of the reference multifunction synthesizer to 180 deg or, if it already is at 180 deg, set it to 0 deg. Repeat the steps for that frequency.

The sample size may be varied to produce the most readable time interval in the shortest time.

Frequency (Hz)	Time Interval Limits (ns)								
	PHASE 1 deg			PHASE 10 deg			PHASE 100 deg		
	Lower	Actual	Upper	Lower	Actual	Upper	Lower	Actual	Upper
100 000	26.4	_____	29.2	276.4	_____	279.2	2 776.4	_____	2 779.2
10 000	264	_____	292	2 764	_____	2 792	27 764	_____	27 792
1 000	2 640	_____	2 920	27 640	_____	27 920	277 640	_____	277 920
100	26 400	_____	29 200	276 400	_____	279 200	2 776 400	_____	2 779 200

NOTE

This concludes the test if the instrument does not have Option 002.

Output 2

5. Set up the equipment as in step 1 except connect the test Multifunction Synthesizer's OUTPUTS 2 HIGH output to the start input of the time interval counter. Refer to Figure 4-4.
6. On test Multifunction Synthesizer, press SHIFT PRESET. After the instrument presets, key in
 - f1 (Channel Config.)
 - NEXT NEXT
 - SHIFT FLOAT 2 OFF
 - FREQ 100 kHz
 - AMPTD 5 V
7. On the reference multifunction synthesizer, press SHIFT PRESET. After the instrument presets, key in
 - f1 (Channel Config.)
 - NEXT
 - SHIFT FLOAT 1 OFF
 - FREQ 100 kHz
 - AMPTD 5 V

8. Set the frequency of both Multifunction Synthesizers as indicated in the following table (as was done in step 4). For each setting, perform the following steps.
 - a. On the test Multifunction Synthesizer, key in PHASE 0 deg.
 - b. Press the set reference key on the counter (that is, press the set reference key of the statistics functions).
 - c. On the test Multifunction Synthesizer, key in the phase as indicated in the table. The time interval on the counter display should be within the limits given in the table.

Frequency (Hz)	Time Interval Limits (ns)								
	PHASE 1 deg			PHASE 10 deg			PHASE 100 deg		
	Lower	Actual	Upper	Lower	Actual	Upper	Lower	Actual	Upper
100 000	26.4	_____	29.2	276.4	_____	279.2	2 776.4	_____	2 779.2
10 000	264	_____	292	2 764	_____	2 792	27 764	_____	27 792
1 000	2 640	_____	2 920	27 640	_____	27 920	277 640	_____	277 920
100	26 400	_____	29 200	276 400	_____	279 200	2 776 400	_____	2 779 200

Performance Test 9

CHANNEL-TO-CHANNEL PHASE ACCURACY (OPTION 001)

Specification

Characteristic	Performance Limits	Conditions
Summation		Option 001
Channel-to-Channel Phase Accuracy	± 0.1 deg or 30 ns whichever is higher	equal signals summed into one output; 0.1 Hz to 100 kHz; sine wave

Description

Channel A and Channel B of the Multifunction Synthesizer are nominally set to the same amplitude but with 180 deg phase difference. The two channels are summed together internally so that the two signals in effect cancel each other. The output is viewed on an oscilloscope.

The amplitude of Channel B is fine adjusted to null the signal as much as possible. The phase of Channel B is fine adjusted also to further null the signal. The amount of phase shift required to null the signal is the phase error between the two channels.

NOTE

For instruments with Option 002 (a second output) and 006 (balanced output), channel-to-channel phase accuracy is specified only for Output 2. For instruments with Option 006 but not Option 002, channel-to-channel phase accuracy is not specified.

Equipment

Oscilloscope HP 1740A or Tektronix 2235

Procedure

1. Connect the Multifunction Synthesizer OUTPUTS 1 HIGH output to the oscilloscope's dc coupled, high-impedance input.

NOTE

For instruments with Option 002 and 006, connect the oscilloscope to OUTPUTS 2 HIGH rather than OUTPUTS 1 HIGH in the step above.

2. On the Multifunction Synthesizer, press SHIFT PRESET. After the instrument presets, key in
 f1 (Channel Config.)
 NEXT
 SHIFT FLOAT 1 OFF
 FREQ 10 kHz
 AMPTD 1 V
 NEXT
 FREQ 10 kHz

SHIFT DESTN 1
 AMPTD 1 V
 INCR SET .5 mV
 PHASE 180 deg
 INCR SET .1 deg

NOTE

For instruments with Option 002 and 006, key in SHIFT FLOAT 2 OFF rather than SHIFT FLOAT 1 OFF in the step above, and key in SHIFT DESTN 2 rather than SHIFT DESTN 1.

3. Adjust the oscilloscope vertical gain and sweep speed to view the nearly nulled 10 kHz output from the Multifunction Synthesizer.
4. On the Multifunction Synthesizer, press AMPTD then press the \uparrow or \downarrow keys, if necessary, to minimize the 10 kHz signal on the oscilloscope.

NOTE

To get a feel for the nature of this measurement, press the amplitude increment keys a few times to un-null the two signals being summed and observe the nature of the signal being monitored. Then re-null the signal and proceed. Ignore any high frequency "fuzziness" on the signal. The only concern is to minimize the 10 kHz component.

5. On the Multifunction Synthesizer, press PHASE then press the \uparrow or \downarrow keys a few times to locate the null of the 10 kHz signal. The null should occur between 179.9 and 180.1 deg. (At 10 kHz, 0.1 deg phase shift represents a delay of 28 ns.)

Phase Null: 179.9 _____ 180.1 deg

6. On the Multifunction Synthesizer, key in

LAST
 FREQ 100 kHz
 NEXT
 FREQ 100 kHz
 AMPTD 1 V
 PHASE 180 deg

7. On the Multifunction Synthesizer, press AMPTD then press the \uparrow or \downarrow keys, if necessary, to minimize the 100 kHz signal on the oscilloscope as was done in step 4.
8. On the Multifunction Synthesizer, press PHASE then press the \uparrow or \downarrow keys a few times to locate the null of the 100 kHz signal. The null should occur between 179.0 and 181.0 deg. (At 100 kHz, 1 deg phase shift represents a delay of 28 ns.)

Phase Null: 179.0 _____ 181.0 deg

Performance Test 10

OUTPUT 1-TO-OUTPUT 2 PHASE ACCURACY (OPTION 002)

Specification

Characteristic	Performance Limits	Conditions
Option 002 Output 1-to-Output 2 Phase Accuracy	± 0.1 deg or 30 ns whichever is higher	at the same frequency; sine wave

Description

Channel A and Channel B of the Multifunction Synthesizer are nominally set to the same amplitude but with 180 deg phase difference. The two channels are summed together externally so that the two signals in effect cancel each other. The output is viewed on an oscilloscope.

The amplitude of Channel B is fine adjusted to null the signal as much as possible. The phase of Channel B is fine adjusted also to further null the signal. The amount of phase shift required to null the signal is the phase error between the two channels.

NOTE

Output 1-to-Output 2 phase accuracy for instruments with both Options 002 and 006 (balanced output) is not specified.

Equipment

Oscilloscope HP 1740A or Tektronix 2235

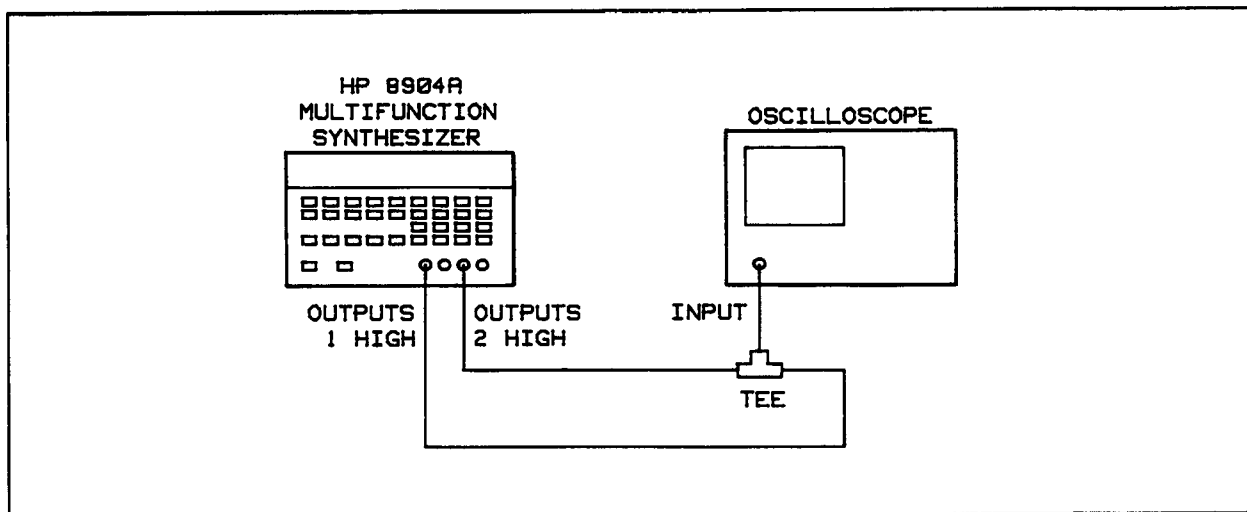

Figure 4-5. Output 1-to-Output 2 Phase Accuracy Performance Test Setup

Procedure

1. Connect the Multifunction Synthesizer OUTPUTS 1 HIGH output and OUTPUTS 2 HIGH output together with a tee, and connect the tee to the oscilloscope's input. Switch the oscilloscope input to 50Ω or connect a 50Ω load at the input using a second tee. Refer to Figure 4-5.
2. On the Multifunction Synthesizer, press SHIFT PRESET. After the instrument presets, key in
 - f1 (Channel Config.)
 - NEXT
 - SHIFT FLOAT 1 OFF
 - FREQ 10 kHz
 - AMPTD 1 V
 - NEXT
 - SHIFT FLOAT 2 OFF
 - FREQ 10 kHz
 - AMPTD 1 V
 - INCR SET .5 mV
 - PHASE 180 deg
 - INCR SET .1 deg
3. Adjust the oscilloscope vertical gain and sweep speed to view the nearly nulled 10 kHz outputs from the Multifunction Synthesizer.
4. On the Multifunction Synthesizer, press AMPTD then press the \uparrow or \downarrow keys, if necessary, to minimize the 10 kHz signal on the oscilloscope.

NOTE

Ignore any high frequency "fuzziness" on the signal. The only concern is to minimize the 10 kHz component.

5. On the Multifunction Synthesizer, press PHASE then press the \uparrow or \downarrow keys a few times to locate the null of the 10 kHz signal. The null should occur between 179.9 and 180.1 deg. (At 10 kHz, 0.1 deg phase shift represents a delay of 28 ns.)

Phase Null: 179.9 _____ 180.1 deg

6. On the Multifunction Synthesizer, key in

- LAST
- FREQ 100 kHz
- NEXT
- FREQ 100 kHz
- AMPTD 1 V
- PHASE 180 deg

7. On the Multifunction Synthesizer, press AMPTD then press the \uparrow or \downarrow keys, if necessary, to minimize the 100 kHz signal on the oscilloscope as was done in step 4.
8. On the Multifunction Synthesizer, press PHASE then press the \uparrow or \downarrow keys a few times to locate the null of the 100 kHz signal. The null should occur between 179.0 and 181.0 deg. (At 100 kHz, 1 deg phase shift represents a delay of 28 ns.)

Phase Null: 179.0 _____ 181.0 deg

Performance Test 11

UNIT-TO-UNIT PHASE ACCURACY (OPTION 005)

Specification

Characteristic	Performance Limits	Conditions
Option 005		
Unit-to-Unit Phase Accuracy	± 0.1 deg or 60 ns whichever is higher	0.1 Hz to 100 kHz

Description

Two Multifunction Synthesizers are synchronized together: one as the master and the other as a slave. Output 1 of each synthesizer is nominally set to the same amplitude but with 180 deg phase difference. The two outputs are summed together so that the two signals in effect cancel each other. The summed signal is viewed on an oscilloscope.

The amplitude of reference synthesizer is fine adjusted to null the signal as much as possible. The phase is then fine adjusted to further null the signal. The amount of phase shift required to null the signal is the phase error between the two instrument outputs.

Equipment

- Oscilloscope HP 1740A or Tektronix 2235
- Multifunction Synthesizer (reference) HP 8904A Option 005
- Power Splitter, Four Way (2 required) Mini-Circuits ZSC-4-3

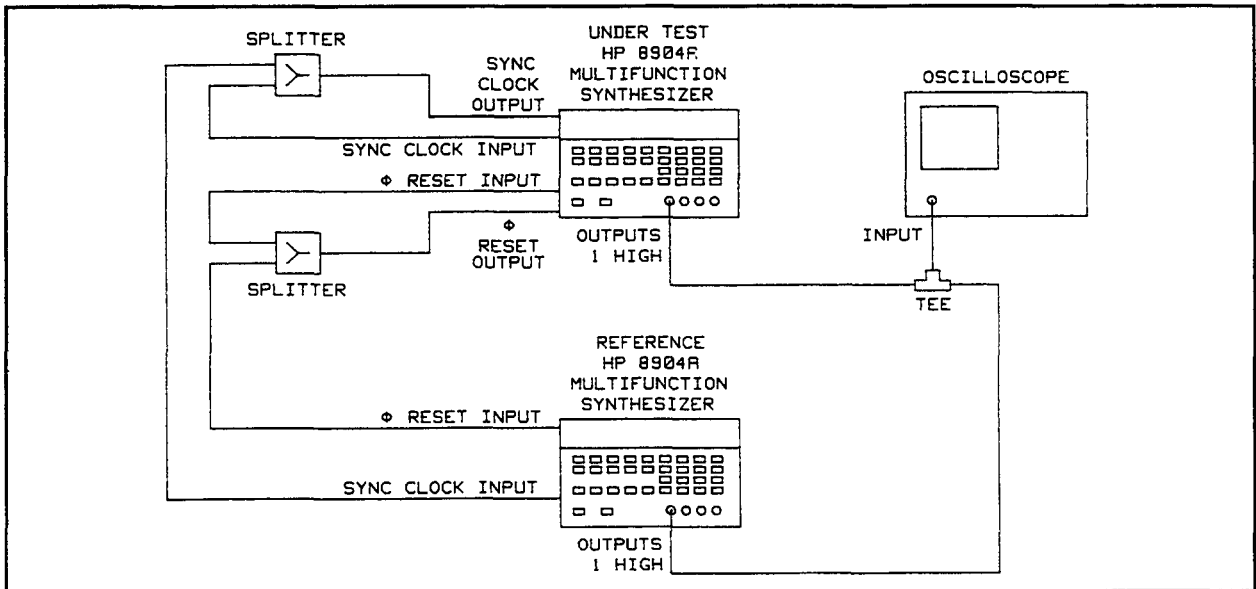

Figure 4-6. Unit-to-Unit Phase Accuracy Performance Test Setup

Procedure

1. Connect the two Multifunction Synthesizers and oscilloscope as noted in the following steps. Refer also to Figure 4-6.
 - a. All phase reset cables, all clock cables, and all signal cables must be the same length.
 - b. The Multifunction Synthesizer under test is the master; therefore, its rear-panel SYNC CLOCK OUTPUT goes to the input of the Clock Splitter and its Φ RESET OUTPUT goes to the input of the Phase Reset Splitter.
 - c. Connect the OUTPUTS 1 HIGH output for both Multifunction Synthesizers together with a tee, and connect the tee to the oscilloscope's input. Switch the oscilloscope input to 50Ω or connect a 50Ω load at the input using a second tee.

NOTE

If either Multifunction Synthesizer has Option 006 in combination with Option 002 and 005, set the destination of Channel A to Output 2 and make the test on Output 2 (which should not be floating).

2. On the Multifunction Synthesizer under test, press SHIFT PRESET. After the instrument presets, key in

```
SHIFT SPECIAL 7 ENTER
f2 (Status) ON
LAST
f2 (Status) ON
f4

f1 (Channel Config.)
NEXT
SHIFT FLOAT 1 OFF
FREQ 10 kHz
AMPTD 1 V
INCR SET .5 mV
PHASE 180 deg
INCR SET .1 deg
```

3. On the reference Multifunction Synthesizer, press SHIFT PRESET. After the instrument presets, key in

```
SHIFT SPECIAL 6 ENTER
f2 (Status) ON
f4

f1 (Channel Config.)
NEXT
SHIFT FLOAT 1 OFF
FREQ 10 kHz
AMPTD 1 V
```

4. On the Multifunction Synthesizer under test, key in SHIFT Φ RESET. Adjust the oscilloscope vertical gain and sweep speed to view the nearly nulled 10 kHz outputs from the Multifunction Synthesizers.
5. On the Multifunction Synthesizer under test, press AMPTD then press the \uparrow or \downarrow keys, if necessary, to minimize the 10 kHz signal on the oscilloscope.

NOTE

Ignore any high frequency "fuzziness" on the signal. The only concern is to minimize the 10 kHz component.

6. On the Multifunction Synthesizer under test, press PHASE then press the \uparrow or \downarrow keys a few times to locate the null of the 10 kHz signal. The null should occur between 179.9 and 180.1 deg. (At 10 kHz, 0.1 deg phase shift represents a delay of 28 ns.)

Phase Null: 179.9 _____ 180.1 deg

7. On the Multifunction Synthesizer under test, key in

FREQ 100 kHz
AMPTD 1 V
PHASE 180 deg

8. On the reference Multifunction Synthesizer, key in AMPTD 1 V.
9. On the Multifunction Synthesizer under test, press AMPTD then press the \uparrow or \downarrow keys, if necessary, to minimize the 100 kHz signal on the oscilloscope as was done in step 6.
10. On the Multifunction Synthesizer under test, press PHASE then press the \uparrow or \downarrow keys a few times to locate the null of the 100 kHz signal. The null should occur between 178.0 and 182.0 deg. (At 100 kHz, 1 deg phase shift represents a delay of 28 ns.)

Phase Null: 178.0 _____ 182.0 deg

Performance Test 12

TONE SEQUENCE TIMING ACCURACY (OPTION 001)

Specification

Characteristic	Performance Limits	Conditions
Tone Sequence		Option 001
On-time Duration	0, 0.8 to 655.35 ms	except 0 off-time and 0 on-time
Off-time Duration	0, 0.8 to 655.35 ms	except 0 off-time and 0 on-time
Timing Accuracy	$\pm 20 \mu\text{s}$	

Description

A repetitive, tone-burst sequence of five, 1 kHz cycles is set up and observed on an oscilloscope. By incrementing the duration of the burst (the on-time), the nominal 5 ms on-time is made to exactly synchronize with the end of the fifth cycle of the burst. The total on-time incrementing equals the on-time error.

The burst's off-time is measured by setting the off-time equal to the previously measured on time (nominally 5 ms) and observing the waveform on an audio spectrum analyzer. The analyzer will display a 1 kHz "carrier" with 100 Hz sidebands. The off-time is incremented until the second sideband of the 1 kHz carrier is suppressed. The total off-time incrementing equals the off-time error.

NOTE

For instruments with Option 006 (balanced output), even though the tone sequences appear at Output 1, tone sequence timing accuracy is not specified.

Equipment

Audio Spectrum Analyzer..... HP 3561A or HP 3580A
 Oscilloscope HP 1740A or Tektronix 2235

Procedure

On-Time Accuracy

1. Connect the Multifunction Synthesizer OUTPUTS 1 HIGH output to the high-impedance, ac coupled oscilloscope's input and to the (non-floating) input of the audio spectrum analyzer using a tee. Refer to Figure 4-7.

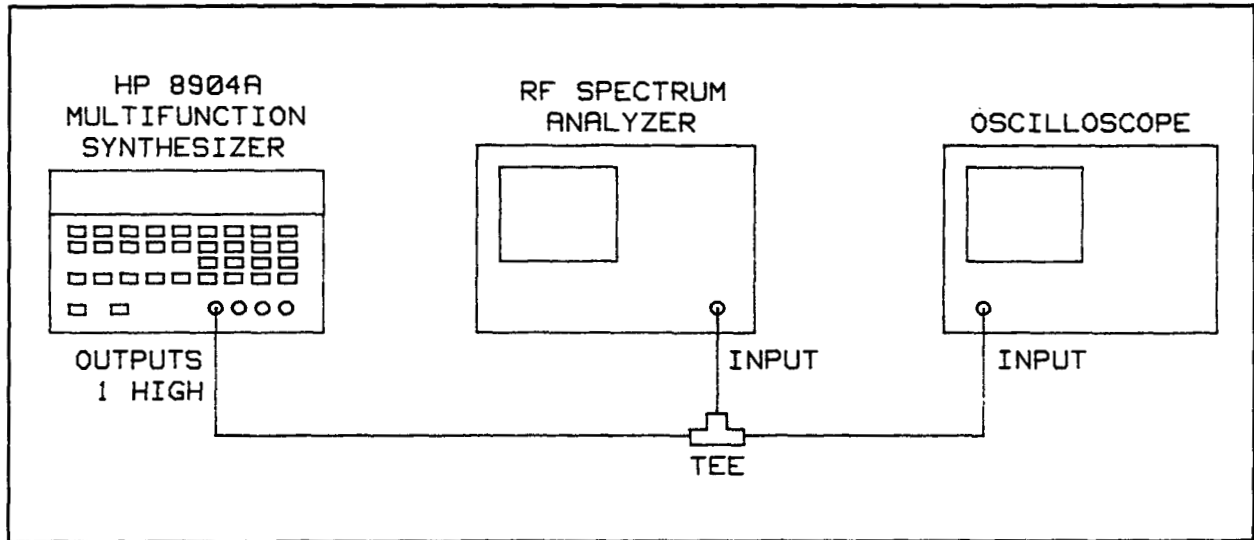

Figure 4-7. Tone Sequence Timing Accuracy Performance Test Setup

2. On the Multifunction Synthesizer, press SHIFT PRESET. After the instrument presets, key in
 - NEXT
 - f1 (Tone Sequence)
 - NEXT
 - SHIFT FLOAT 1 OFF
 - FREQ 1 kHz
 - f2 (On Time) 5 ms
 - INCR SET .01 ms
 - f4 (Off Time) 10 ms
 - INCR SET .01 ms
 - NEXT
 - f2 (Seq End) 1 ENTER
 - NEXT
 - AMPTD 1 V
 - f2 (Continuous)
 - NEXT NEXT
 - f2 (On Time)
3. Adjust the oscilloscope's vertical gain and sweep speed to view the 1 kHz output burst from the Multifunction Synthesizer. The waveform should appear similar to the one shown in Figure 4-8.

NOTE

The waveform shown was triggered on a negative-going zero crossing. If the oscilloscope is difficult to trigger, try adjusting the sweep time so that only one tone burst shows. Sweep time is not critical. Also try "normal" triggering (as opposed to "automatic" triggering). If fewer than five cycles of the burst show, the display is still valid unless the waveform is unstable.

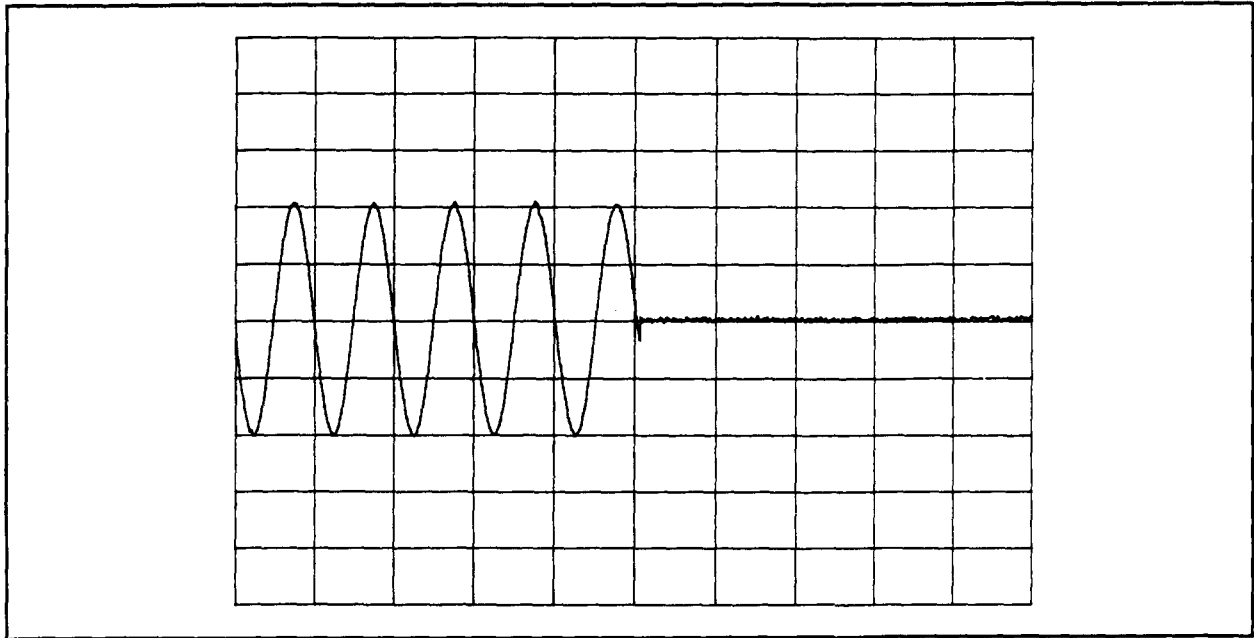

Figure 4-8. *Tone Burst Waveform with Slight Negative Slewing*

4. On the Multifunction Synthesizer, press the \uparrow or \downarrow keys until the negative-going zero crossing of the last cycle of the tone burst touches 0V with no positive or negative slewing. (Slewing refers to the rapid change in voltage which appears as a vertical line on the oscilloscope.) The “On Time” setting which appears on the Multifunction Synthesizer’s display should be between 4.98 and 5.02 ms.

On-Time Timing: 4.98 _____ 5.02 ms

Off-Time Accuracy

5. On the Multifunction Synthesizer, press f4 (Off Time), key in the number recorded in step 4, then press ms. (The off-time should equal the on-time as shown on the Multifunction Synthesizer’s display and should be approximately 5 ms.)
6. Adjust the spectrum analyzer to observe the 1 kHz tone burst and its 100 Hz sidebands. Refer to Figure 4-9.
7. On the Multifunction Synthesizer, press the \uparrow or \downarrow keys until the second upper sideband of the 1 kHz carrier is nulled. The “Off Time” setting which appears on the Multifunction Synthesizer’s display should be within 0.01 ms of the “On Time” setting.

Off-Time Timing Difference: -0.01 _____ 0.01 ms

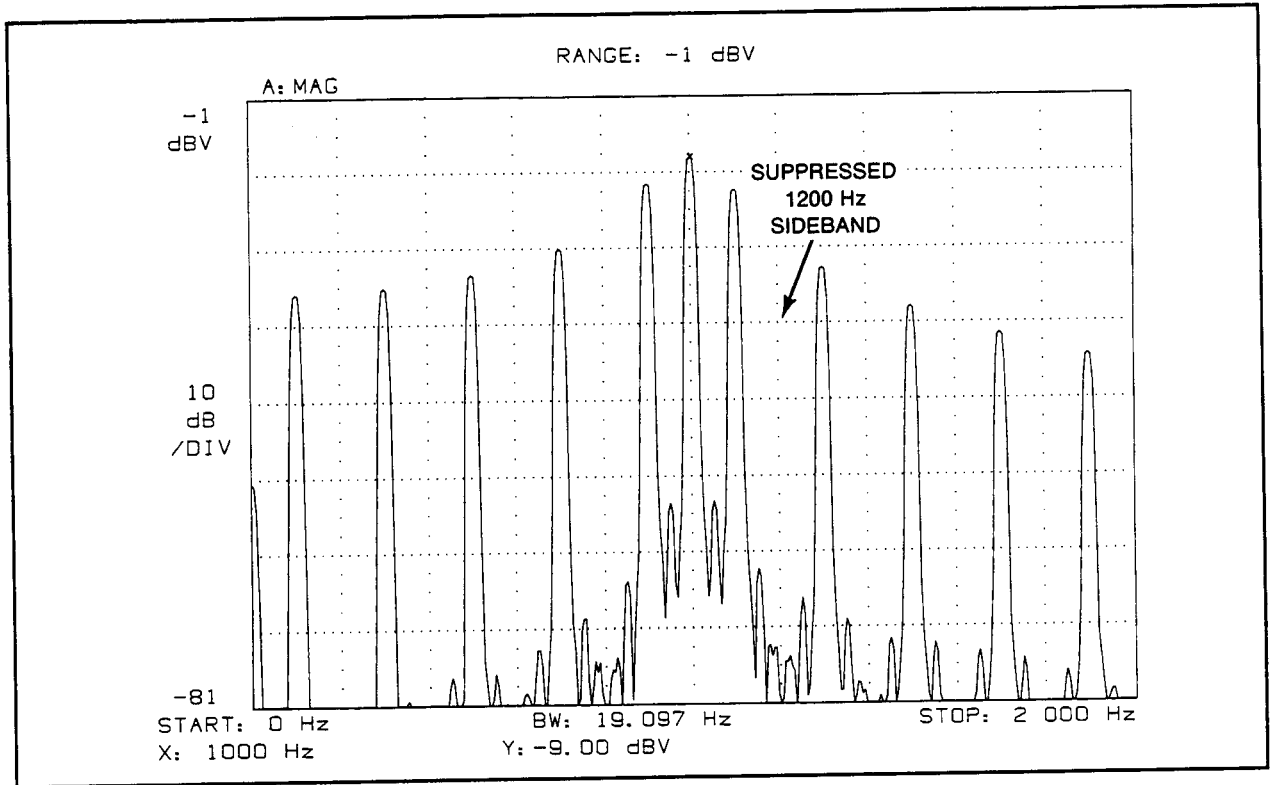

Figure 4-9. Tone Burst Spectrum with Suppressed 1200 Hz Sideband

Performance Test 13

DTMF SEQUENCE TIMING ACCURACY (OPTION 001)

Specification

Characteristic	Performance Limits	Conditions
DTMF Sequence		Option 001
On-time Duration	0, 1 to 655.35 ms	except 0 off-time and 0 on-time
Off-time Duration	0, 1 to 655.35 ms	except 0 off-time and 0 on-time
Timing Accuracy	± 1 ms	

Description

A tone burst of several cycles of DTMF Tone 0 is set up and observed on an oscilloscope. By incrementing the duration of the burst (the on-time), the nominal on-time is made to exactly synchronize with the fourteenth zero crossing of the burst. The total on-time incrementing equals the on-time error. The burst's off-time is measured directly on the oscilloscope.

NOTE

For instruments with Option 006 (balanced output), even though the DTMF sequences appear at Output 1, DTMF sequence timing accuracy is not specified.

Equipment

Oscilloscope HP 1740A or Tektronix 2235

Procedure

On-Time Accuracy

1. Connect the Multifunction Synthesizer OUTPUTS 1 HIGH output to the high-impedance, ac coupled oscilloscope's input.
2. On the Multifunction Synthesizer, press SHIFT PRESET. After the instrument presets, key in

NEXT
f3 (DTMF Sequence)

NEXT
SHIFT FLOAT 1 OFF
f2 (On Time) 5.27 ms
f4 (Off Time) 10 ms

NEXT
f2 (Seq End) 1 ENTER
NEXT

AMPTD 1 V
f2 (Continuous)

NEXT NEXT
f2 (On Time)

- Adjust the oscilloscope's vertical gain and sweep speed to view the 1 kHz output burst from the Multifunction Synthesizer. The waveform should appear similar to the one shown in Figure 4-10.

NOTE

The waveform shown was triggered on a negative-going zero crossing. If the oscilloscope is difficult to trigger, try adjusting the sweep time so that only one tone burst shows. Sweep time is not critical. Also try "normal" triggering (as opposed to "automatic" triggering). If fewer than fourteen zero-crossings of the burst show, the display is still valid unless the waveform is unstable.

- On the Multifunction Synthesizer, press the \uparrow or \downarrow keys until the negative-going zero crossing of the last cycle of the tone burst touches 0V with no positive or negative slewing. (Slewing refers to the rapid change in voltage which appears as a vertical line on the oscilloscope.) The "On Time" setting which appears on the Multifunction Synthesizer's display should be between 4.27 and 6.27 ms.

On-Time Timing: 4.27 _____ 6.27 ms

Off-Time Accuracy

- On the oscilloscope adjust the sweep time and position so that the time between the first and second burst (the off-time) can be measured. The off-time should be between 9 and 11 ms.

Off-Time Timing: 9 _____ 11 ms

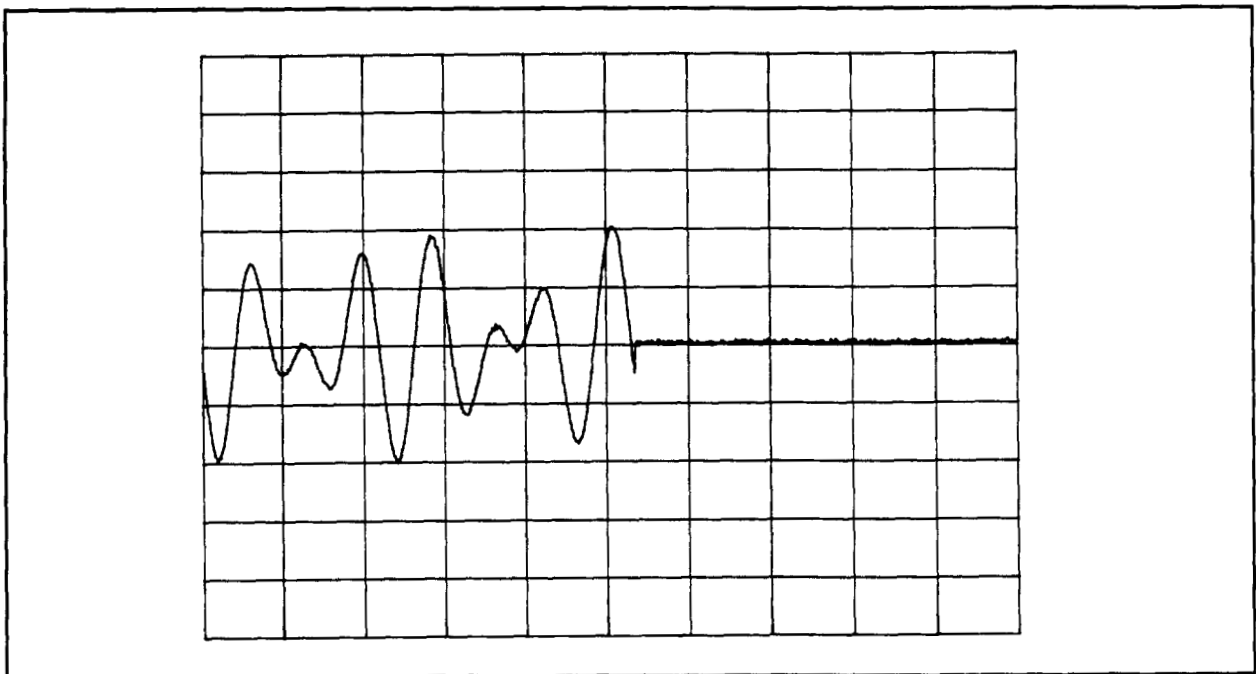

Figure 4-10. DTMF Burst Waveform with Slight Negative Slewing

Performance Test 14

DIGITAL SEQUENCE PERIOD ACCURACY (OPTION 001)

Specification

Characteristic	Performance Limits	Conditions
Digital Sequence		Option 001
Period Duration	0.1 to 655.35 ms	
Period Accuracy	$\pm 20 \mu\text{s}$	

Description

A repetitive squarewave with an on-time of $100 \mu\text{s}$ and an off-time of $900 \mu\text{s}$ is set up on an oscilloscope. The on-time period is measured directly.

NOTE

For instruments with Option 006 (balanced output), digital sequences are not useable and are not specified.

Equipment

Oscilloscope HP 1740A or Tektronix 2235

Procedure

1. Connect the Multifunction Synthesizer OUTPUTS 1 HIGH output to the high-impedance, ac coupled oscilloscope's input.
2. On the Multifunction Synthesizer, press SHIFT PRESET. After the instrument presets, key in
 - NEXT NEXT
 - f1 (Digital Sequence)
 - NEXT
 - SHIFT FLOAT 1 OFF
 - f1 (Seq Base Hex)
 - f1 (Seq Base Bin)
 - f2 (On Lev) 1 V
 - NEXT
 - f4 (Edit Sequence) 1000000000
 - f2 (Seq End) 10 ENTER
 - NEXT
 - f2 (Continuous)
3. Adjust the oscilloscope's vertical gain, sweep speed, and triggering to view the $100 \mu\text{s}$ pulse of the waveform from the Multifunction Synthesizer. The on-period should be between 80 and $120 \mu\text{s}$. (The observed pulse-width jitter should be included as part of the on-period error.)

On-Period: 80 _____ $120 \mu\text{s}$

Table 4-1. Performance Test Record (2 of 7)

Test No.	Test Description	Results		
		Minimum	Actual	Maximum
2	AC AND DC AMPLITUDE ACCURACY (EXCEPT OUTPUT 1 WITH OPTION 006) (Continued)			
	AC Amplitude Accuracy-Output 1			
	<i>Frequency Setting</i>			
	0.1 Hz	-0.08 div	_____	0.08 div
	1 kHz	-0.08 div	_____	0.08 div
	100 kHz	-0.08 div	_____	0.08 div
	600 kHz	-0.24 div	_____	0.24 div
	DC Amplitude Accuracy-Output 2			
	<i>Amplitude Setting</i>			
	10 V	9.794 Vdc	_____	10.21 Vdc
	5.01 V	4.907 Vdc	_____	5.115 Vdc
	5 V	4.897 Vdc	_____	5.105 Vdc
	2.5 V	2.449 Vdc	_____	2.553 Vdc
	1.25 V	1.224 Vdc	_____	1.276 Vdc
	625 mV	604 mVdc	_____	646 mVdc
	312 mV	291 mVdc	_____	333 mVdc
	156.2 mV	135.2 mVdc	_____	177.2 mVdc
	78.1 mV	57.1 mVdc	_____	99.1 mVdc
	39.0 mV	18.0 mVdc	_____	60.0 mVdc
	19.5 mV	-1.5 mVdc	_____	40.5 mVdc
	10.0 mV	-11.0 mVdc	_____	31.0 mVdc
	-10 V	-10.21 Vdc	_____	-9.794 Vdc
	-5.01 V	-5.115 Vdc	_____	-4.907 Vdc
	-5 V	-5.105 Vdc	_____	-4.897 Vdc
	-2.5 V	-2.553 Vdc	_____	-2.449 Vdc
	-1.25 V	-1.276 Vdc	_____	-1.244 Vdc
	-625 mV	-646 mVdc	_____	-604 mVdc
	-312 mV	-333 mVdc	_____	-291 mVdc
	-156.2 mV	-177.2 mVdc	_____	-135.2 mVdc
	-78.1 mV	-99.1 mVdc	_____	-57.1 mVdc
	-39.0 mV	-60.0 mVdc	_____	-18.0 mVdc
	-19.5 mV	-40.5 mVdc	_____	1.5 mVdc
	-10.0 mV	-31.0 mVdc	_____	11.0 mVdc
AC Amplitude Accuracy-Output 2				
<i>Frequency Setting</i>				
0.1 Hz	-0.08 div	_____	0.08 div	
1 kHz	-0.08 div	_____	0.08 div	
100 kHz	-0.08 div	_____	0.08 div	
600 kHz	-0.24 div	_____	0.24 div	

Table 4-1. Performance Test Record (3 of 7)

Test No.	Test Description	Results		
		Minimum	Actual	Maximum
3	AC AMPLITUDE FLATNESS (EXCEPT OUTPUT 1 WITH OPTION 006)			
	<p>Output 1</p> <p><i>Frequency Range</i> 20 Hz to 100 kHz 100 to 600 kHz</p> <p>Output 2 (Option 002)</p> <p><i>Frequency Range</i> 20 Hz to 100 kHz 100 to 600 kHz</p>		<p>_____</p> <p>_____</p> <p>_____</p> <p>_____</p>	<p>2 increments</p> <p>20 increments</p> <p>2 increments</p> <p>20 increments</p>
4	AC AMPLITUDE ACCURACY AND FLATNESS (OUTPUT 1 WITH OPTION 006)			
	AC Amplitude Accuracy			
	<i>Frequency and Amplitude Settings</i>			
	30 Hz, 10 V	9.4 V	_____	10.6 V
	100 Hz, 10 V	9.4 V	_____	10.6 V
	1 kHz, 10 V	9.4 V	_____	10.6 V
	10 kHz, 10 V	9.4 V	_____	10.6 V
	20 kHz, 10 V	9.4 V	_____	10.6 V
	100 kHz, 10 V	8.8 V	_____	11.2 V
	30 Hz, 1 V	0.94 V	_____	1.06 V
	100 Hz, 1 V	0.94 V	_____	1.06 V
	1 kHz, 1 V	0.94 V	_____	1.06 V
	10 kHz, 1 V	0.94 V	_____	1.06 V
	20 kHz, 1 V	0.94 V	_____	1.06 V
	100 kHz, 1 V	0.88 V	_____	1.12 V
	30 Hz, 0.1 V	0.094 V	_____	0.106 V
	100 Hz, 0.1 V	0.094 V	_____	0.106 V
	1 kHz, 0.1 V	0.094 V	_____	0.106 V
	10 kHz, 0.1 V	0.094 V	_____	0.106 V
	20 kHz, 0.1 V	0.094 V	_____	0.106 V
	100 kHz, 0.1 V	0.088 V	_____	0.112 V
	AC Amplitude Flatness			
	<i>Frequency Setting</i>			
	30 Hz	9.83 V	_____	10.17 V
	100 Hz	9.83 V	_____	10.17 V
	1 kHz	9.83 V	_____	10.17 V
	10 kHz	9.83 V	_____	10.17 V
20 kHz	9.83 V	_____	10.17 V	
100 kHz	9.83 V	_____	10.17 V	

Table 4-1. Performance Test Record (4 of 7)

Test No.	Test Description	Results		
		Minimum	Actual	Maximum
5	SPECTRAL PURITY (EXCEPT OUTPUT 1 WITH OPTION 006)			
	Output 1			
	<i>Frequency and Amplitude Settings</i>			
	20 Hz (10V, 30 kHz BW)		_____	-63 dB
	7.5 kHz (10V, 30 kHz BW)		_____	-63 dB
	7.5 kHz (10V, 80 kHz BW)		_____	-63 dB
	20 kHz (10V, 80 kHz BW)		_____	-63 dB
	20 kHz (10V, 750 kHz BW)		_____	-55 dB
	100 kHz (10V, 750 kHz BW)		_____	-55 dB
	20 Hz (0.14V, 30 kHz BW)		_____	-63 dB
	7.5 kHz (0.14V, 30 kHz BW)		_____	-63 dB
	7.5 kHz (0.14V, 80 kHz BW)		_____	-63 dB
	20 kHz (0.14V, 80 kHz BW)		_____	-63 dB
	20 kHz (0.14V, 750 kHz BW)		_____	-55 dB
	100 kHz (0.14V, 750 kHz BW)		_____	-55 dB
	Output 2 (Option 002)			
	<i>Frequency and Amplitude Settings</i>			
	20 Hz (10V, 30 kHz BW)		_____	-63 dB
	7.5 kHz (10V, 30 kHz BW)		_____	-63 dB
	7.5 kHz (10V, 80 kHz BW)		_____	-63 dB
	20 kHz (10V, 80 kHz BW)		_____	-63 dB
	20 kHz (10V, 750 kHz BW)		_____	-55 dB
	100 kHz (10V, 750 kHz BW)		_____	-55 dB
	20 Hz (0.14V, 30 kHz BW)		_____	-63 dB
	7.5 kHz (0.14V, 30 kHz BW)		_____	-63 dB
	7.5 kHz (0.14V, 80 kHz BW)		_____	-63 dB
	20 kHz (0.14V, 80 kHz BW)		_____	-63 dB
	20 kHz (0.14V, 750 kHz BW)		_____	-55 dB
	100 kHz (0.14V, 750 kHz BW)		_____	-55 dB

Table 4-1. Performance Test Record (5 of 7)

Test No.	Test Description	Results		
		Minimum	Actual	Maximum
6	SPECTRAL PURITY (OUTPUT 1 WITH OPTION 006)			
	<i>Frequency and Amplitude Settings</i>			
	300 Hz (10V, 30 kHz BW)		_____	-60 dB
	7.5 kHz (10V, 80 kHz BW)		_____	-63 dB
	20 kHz (10V, 80 kHz BW)		_____	-63 dB
	20 kHz (10V, 750 kHz BW)		_____	-55 dB
	100 kHz (10V, 750 kHz BW)		_____	-55 dB
	30 Hz (1V, 30 kHz BW)		_____	-46 dB
	300 Hz (1V, 30 kHz BW)		_____	-60 dB
	7.5 kHz (1V, 80 kHz BW)		_____	-63 dB
	20 kHz (1V, 80 kHz BW)		_____	-63 dB
	20 kHz (1V, 750 kHz BW)		_____	-55 dB
	100 kHz (1V, 750 kHz BW)		_____	-55 dB
	20 Hz (0.14V, 30 kHz BW)		_____	-63 dB
	7.5 kHz (0.14V, 30 kHz BW)		_____	-63 dB
	7.5 kHz (0.14V, 80 kHz BW)		_____	-63 dB
	20 kHz (0.14V, 80 kHz BW)		_____	-63 dB
	20 kHz (0.14V, 750 kHz BW)		_____	-55 dB
	100 kHz (0.14V, 750 kHz BW)		_____	-55 dB
	7	PHASE ACCURACY (USING AN OSCILLOSCOPE)		
Output 1				
<i>Frequency Setting</i>				
100 kHz		-0.05 deg	_____	0.05 deg
50 kHz		-0.05 deg	_____	0.05 deg
20 kHz		-0.05 deg	_____	0.05 deg
1 kHz		-0.05 deg	_____	0.05 deg
100 Hz		-0.05 deg	_____	0.05 deg
Output 2 (Option 002)				
<i>Frequency Setting</i>				
100 kHz		-0.05 deg	_____	0.05 deg
50 kHz		-0.05 deg	_____	0.05 deg
20 kHz		-0.05 deg	_____	0.05 deg
1 kHz		-0.05 deg	_____	0.05 deg
100 Hz	-0.05 deg	_____	0.05 deg	

Table 4-1. Performance Test Record (6 of 7)

Test No.	Test Description	Results		
		Minimum	Actual	Maximum
8	PHASE ACCURACY (USING A TIME INTERVAL COUNTER)			
	Output 1			
	<i>Frequency and Phase Settings</i>			
	100 kHz, 1 deg	26.4 ns	_____	29.2 ns
	100 kHz, 10 deg	276.4 ns	_____	279.2 ns
	100 kHz, 100 deg	2776.4 ns	_____	2779.2 ns
	10 kHz, 1 deg	264 ns	_____	292 ns
	10 kHz, 10 deg	2 764 ns	_____	2 792 ns
	10 kHz, 100 deg	27 764 ns	_____	27 792 ns
	1 kHz, 1 deg	2 640 ns	_____	2 920 ns
	1 kHz, 10 deg	27 640 ns	_____	27 920 ns
	1 kHz, 100 deg	277 640 ns	_____	277 920 ns
	100 Hz, 1 deg	26 400 ns	_____	29 200 ns
	100 Hz, 10 deg	276 400 ns	_____	279 200 ns
	100 Hz, 100 deg	2 776 400 ns	_____	2 779 200 ns
	Output 2 (Option 002)			
	<i>Frequency and Phase Settings</i>			
	100 kHz, 1 deg	26.4 ns	_____	29.2 ns
	100 kHz, 10 deg	276.4 ns	_____	279.2 ns
	100 kHz, 100 deg	2776.4 ns	_____	2779.2 ns
	10 kHz, 1 deg	264 ns	_____	292 ns
	10 kHz, 10 deg	2 764 ns	_____	2 792 ns
	10 kHz, 100 deg	27 764 ns	_____	27 792 ns
	1 kHz, 1 deg	2 640 ns	_____	2 920 ns
	1 kHz, 10 deg	27 640 ns	_____	27 920 ns
	1 kHz, 100 deg	277 640 ns	_____	277 920 ns
	100 Hz, 1 deg	26 400 ns	_____	29 200 ns
	100 Hz, 10 deg	276 400 ns	_____	279 200 ns
	100 Hz, 100 deg	2 776 400 ns	_____	2 779 200 ns

Table 4-1. Performance Test Record (7 of 7)

Test No.	Test Description	Results		
		Minimum	Actual	Maximum
9	CHANNEL-TO-CHANNEL PHASE ACCURACY (OPTION 001) Null at 10 kHz Null at 100 kHz	179.9 deg 179.0 deg	_____ _____	180.1 deg 181.0 deg
10	OUTPUT 1-TO-OUTPUT 2 PHASE ACCURACY (OPTION 002) Null at 10 kHz Null at 100 kHz	179.9 deg 179.0 deg	_____ _____	180.1 deg 181.0 deg
11	UNIT-TO-UNIT PHASE ACCURACY (OPTION 005) Null at 10 kHz Null at 100 kHz	179.9 deg 178.0 deg	_____ _____	180.1 deg 182.0 deg
12	TONE SEQUENCE TIMING ACCURACY (OPTION 001) On-Time Timing Off-Time Timing Difference	4.98 ms -0.01 ms	_____ _____	5.02 ms 0.01 ms
13	DTMF SEQUENCE TIMING ACCURACY (OPTION 001) On-Time Timing Off-Time Timing	4.27 ms 9 ms	_____ _____	6.27 ms 11 ms
14	DIGITAL SEQUENCE PERIOD ACCURACY (OPTION 001) On-Period	80 μ s	_____	120 μ s

Section 5 ADJUSTMENTS

5-1. INTRODUCTION

This section contains adjustments and checks that assure peak performance of the Multifunction Synthesizer. The instrument should be readjusted after repair or failure to pass a performance test. Allow a 10 minute warm-up prior to performing the adjustments. Removing the top and bottom covers is the only disassembly required for most adjustments on a standard instrument. An instrument with two outputs, Option 002, will require removing the A10 Output Assembly if the A3 Output Assembly requires adjustment. (The disassembly procedure is shown in Figure 5-4.)

NOTE

The instrument has been fully tested and calibrated prior to shipment. It is preferable that no adjustments be made to the instrument unless it has failed during performance testing (see Section 4).

To determine which performance tests and adjustments to perform after a repair, refer to paragraph 5-4, *Post-Repair Tests, Adjustments, and Checks*.

5-2. SAFETY CONSIDERATIONS

This section contains information, cautions, and warnings which must be followed for your protection and to avoid damage to the equipment.

CAUTION

This instrument contains components that are highly susceptible to damage from static discharge. Always observe proper ESD safety procedures while making any measurements or touching any part of the inside of the instrument.

WARNING

Most adjustments described in this section are performed with power supplied to the instrument and with protective covers removed. Maintenance should be performed only by service trained personnel who are aware of the hazard involved (for example, fire and electrical shock). Where maintenance can be performed without power applied, the power should be removed.

Removal of the Multifunction Synthesizer's top and bottom covers is necessary to perform these adjustments. The exposed power supply contains circuitry operating at a potential of ≈ 160 Vac. Be very careful to not rest your hands, tools, or anything else against any part of the power supply.

Immediately below the top of the rear frame rail are the line-power socket, fuse holder, and line-voltage-select switch. If the instrument must be moved while being adjusted, be careful not to let your fingers touch the terminals on any of these parts while moving.

WARNING

A pin-to-pin voltage difference of 32 Vdc may be found on many of the Multifunction Synthesizer's circuit board connectors. Be careful while working on the circuit boards with power supplied to the instrument.

The back-light drive for the front-panel-display utilizes a ≈ 100 Vac signal. Be careful when working on or near the front panel to avoid touching any exposed wires on the connector to the display.

5-3. EQUIPMENT REQUIRED

Each adjustment procedure contains a list of required test equipment. The test equipment is identified by callouts in the test setup diagrams where included.

If substitutions must be made for the specified test equipment, refer to Table 1-2 for the minimum specifications. It is important that the test equipment meet the critical specifications listed in the table if the Multifunction Synthesizer is to meet its performance requirements.

5-4. POST-REPAIR TESTS, ADJUSTMENTS, AND CHECKS

Table 5-1 lists the performance tests, adjustments, and checks needed to calibrate or verify calibration of a repaired assembly. The tests, adjustments, and checks are classified by the assembly repaired or replaced. Table 5-1 is also useful as a cross reference between performance tests and assemblies when the failure is a specification that is slightly out of limits.

The Basic Functional Checks mentioned in the table are explained in the introduction to Section 4.

Table 5-1. Post-Repair Tests, Adjustments, and Checks

Assembly Repaired	Performance Test, Adjustment, or Check
A1 Keyboard Assembly	Basic Functional Checks
A2 Controller Assembly	Reinstall Options 001, 003, and 005 if formerly in the instrument. Basic Functional Checks Performance Test 1 – Frequency Accuracy Adjustment 6 – Display Backlighting and Contrast Adjustment 7 – Phase Synchronization (Option 005)
A3 Output Assembly A10 Output Assembly (Option 002)	Basic Functional Checks Performance Test 2 – AC and DC Amplitude Accuracy (Except Output 1 with Option 006) Performance Test 3 – AC Amplitude Flatness (Except Output 1 with Option 006) Performance Test 4 – AC Amplitude Accuracy and Flatness (Output 1 with Option 006) Performance Test 5 – Spectral Purity (Except Output 1 with Option 006) Performance Test 6 – Spectral Purity (Output 1 with Option 006) Performance Test 7 – Phase Accuracy (Using an Oscilloscope) Performance Test 8 – Phase Accuracy (Using a Time Interval Counter) Performance Test 9 – Channel-to-Channel Phase Accuracy (Option 001) Performance Test 10 – Output 1-to-Output 2 Phase Accuracy (Option 002) Performance Test 11 – Unit-to-Unit Phase Accuracy (Option 005) Performance Test 12 – Tone Sequence Timing Accuracy (Option 001) Performance Test 13 – DTMF Sequence Timing Accuracy (Option 001) Performance Test 14 – Digital Sequence Period Accuracy (Option 001) Adjustment 1 – Output Gain and Offset Adjustment 2 – Output Balance Adjustment 3 – Output Gain (Option 006) Adjustment 4 – Sharp Cutoff Low-Pass Filter Adjustment 5 – Sine X/X Compensation
A4 Power Supply Assembly	Basic Functional Checks Performance Test 5 – Spectral Purity (Except Output 1 with Option 006) Performance Test 6 – Spectral Purity (Output 1 with Option 006)
A5 Display Assembly	Basic Functional Checks Adjustment 6 – Display Backlighting and Contrast
A6 High Power Output Assembly (Option 006)	Basic Functional Checks Performance Test 4 – AC Amplitude Accuracy and Flatness (Output 1 with Option 006) Adjustment 3 – Output Gain (Option 006)

Adjustment 1

OUTPUT GAIN AND OFFSET

Description

Four adjustments are made to the A3 or A10 Output Assemblies. If the instrument has only one Output Assembly (A3), the adjustments are made only to it. If the instrument has Option 002 with two Output Assemblies (A3 and A10), adjustments are made to one or both assemblies. Accessing A3 will require extra disassembly. If the instrument has Option 006 (balanced output), adjustments are made on the A3 assembly with the balance transformer disconnected. The four adjustments are made as follows:

1. The DAC range is calibrated at maximum ac output (10 Vpp).
2. The dc offset of the Audio Amplifier is adjusted for 0 Vdc.
3. The dc offset of the Floating Output Amplifier is adjusted for 0 Vdc.
4. The DAC range is again calibrated but at maximum dc output (10 Vdc).

Equipment

Digital Voltmeter HP 3478A

Procedure

Setup

1. Remove the instrument's bottom cover.
2. If the instrument has Option 002 (a second output assembly) and Output 1 (the output from the A3 Output Assembly) is to be adjusted, move the A10 Output Assembly out of the way. (Refer to the disassembly procedure in Figure 5-4.)
3. If the instrument has Option 006 (balanced output), disconnect the coax cable from A3J400 (OUTPUT HIGH) at the front edge of the A3 assembly. In the steps that follows, when a reference is made to the OUTPUTS 1 HIGH connector, make the connection to A3J400 instead.

Maximum AC

4. Connect the Multifunction Synthesizer OUTPUTS 1 HIGH output for the A3 Output Assembly or OUTPUTS 2 HIGH for the A10 Output Assembly to the voltmeter input. Switch LINE to ON.
5. On the Multifunction Synthesizer, press SHIFT PRESET. After the instrument presets, key in

<u>For A3 Output Assembly</u>	<u>For A10 Output Assembly</u>
f1 (Channel Config.)	f1 (Channel Config.)
NEXT	NEXT NEXT
SHIFT FLOAT 1 OFF	SHIFT FLOAT 2 OFF
FREQ 1 kHz	FREQ 1 kHz
AMPTD 10 V	AMPTD 10 V

6. Set the voltmeter to measure ac volts. Adjust A3R224 or A10R224 (DAC LEVEL) for a level between 7.06 and 7.07 Vac. (Refer to the Component Locator, Figure 5-6.)

Audio Amplifier Offset

7. Connect the voltmeter probes to A3TP4 or A10TP4 (output of Audio Amplifier) and to A3TP8 or A10TP8 (ground). Set the voltmeter to measure dc volts.
8. On the Multifunction Synthesizer, key in

For A3 Output Assembly

WAVE FORM \equiv
AMPTD 0 V

For A10 Output Assembly

WAVE FORM \equiv
AMPTD 0 V

9. On the Multifunction Synthesizer, adjust A3R229 or A10R229 (DC OFFSET1) for a level between -0.5 and $+0.5$ mVdc.

Output Amplifier Offset

10. Connect the Multifunction Synthesizer OUTPUTS 1 HIGH output for the A3 Output Assembly, or OUTPUTS 2 HIGH for the A10 Output Assembly, to the voltmeter input.
11. On the Multifunction Synthesizer, key in AMPTD 40 mV.
12. Adjust A3R418 or A10R418 (DC OFFSET) for a level between $+40.1$ and $+39.9$ mVdc.

Maximum DC

13. On the Multifunction Synthesizer, key in AMPTD 10 V.
14. On the Multifunction Synthesizer, adjust A3R224 or A10R224 (DAC LEVEL) for a level between $+9.99$ and $+10.01$ Vdc.
15. Perform Adjustment 2.

Adjustment 2

OUTPUT BALANCE

Description

This adjustment minimizes the signal on the low output of the Floating Output Amplifier on the A3 or A10 Output Assemblies. If the instrument has only one Output Assembly (A3), the adjustments are made only to it. If the instrument has Option 002 with two Output Assemblies (A3 and A10), adjustments are made to one or both assemblies. Accessing A3 will require extra disassembly. If the instrument has Option 006 (balanced output), adjustments are made on the A3 assembly with the balance transformer disconnected.

The instrument is set to produce a 10 Vpk sine wave at 100 kHz into the amplifier. The 48 dB Attenuator following the amplifier is set to 48 dB so that the amplifier drives a 50 Ω load. The unbalanced signal is monitored by an oscilloscope at the testpoint on the low output. The testpoint has a resistor in series with it to prevent the oscilloscope from unbalancing the amplifier.

Equipment

Oscilloscope HP 1740A or Tektronix 2235

Procedure

1. Remove the instrument's bottom cover.
2. If the instrument has Option 002 (a second output assembly) and Output 1 (the output from the A3 Output Assembly) is to be adjusted, move the A10 Output Assembly out of the way. (Refer to the disassembly procedure in Figure 5-4.)
3. If the instrument has Option 006 (balanced output), disconnect the coax cable from A3J400 (OUTPUT HIGH) at the front edge of the A3 assembly. In the steps that follows, when a reference is made to the OUTPUTS 1 HIGH connector, make the connection to A3J400 instead.
4. Connect the oscilloscope's ac coupled, vertical input to A3TP402 or A10TP402 (FLT LO) on the Multifunction Synthesizer. The oscilloscope should have a low-capacitance 10:1 divider probe.
5. On the Multifunction Synthesizer, press SHIFT PRESET. After the instrument presets, key in

For A3 Output Assembly

f1 (Channel Config.)
NEXT
FREQ 100 kHz
AMPTD 40 mV

For A10 Output Assembly

f1 (Channel Config.)
NEXT NEXT
FREQ 100 kHz
AMPTD 40 mV

6. Set the oscilloscope to measure the 100 kHz signal. Adjust A3C425 or A10C425 (HIGH FREQUENCY BALANCE) for minimum 100 kHz signal on the oscilloscope but less than 50 mVpp (after accounting for the 10:1 division by the probe). Use a non-metalic tuning tool. (Refer to the Component Locator, Figure 5-6.)
7. If the Multifunction Synthesizer has Option 006, reconnect the coax to A3J400 and perform Adjustment 3.

Adjustment 3

OUTPUT GAIN (OPTION 006)

Description

The gain of the A6 High Power Output Assembly is adjusted so that the output amplitude for a sinewave is correct when the output is terminated and open circuit. This adjustment is made after performing Adjustments 1 and 2.

Equipment

Digital Voltmeter	HP 3478A
Feedthrough Termination, 600Ω	HP 11095A

Procedure

1. Remove the instrument's bottom cover.
2. Connect the Multifunction Synthesizer OUTPUTS 1 HIGH output to the voltmeter input. (Do not use a feedthrough termination at this time.) Switch LINE to ON.
3. On the Multifunction Synthesizer, press SHIFT PRESET. After the instrument presets, key in
 - f1 (Channel Config.)
 - NEXT
 - SHIFT FLOAT 1 OFF
 - AMPTD 10 V
4. On the Multifunction Synthesizer, adjust A6R1 until the voltmeter reads between 19.8 and 20.2 Vrms.
5. Connect a 600Ω feedthrough termination at the voltmeter's input.
6. On the Multifunction Synthesizer, adjust A6R5 until the voltmeter reads between 9.9 and 10.1 Vrms.

Adjustment 4

SHARP CUTOFF LOW-PASS FILTER

Description

The frequency response of the Sharp Cutoff Low-Pass Filter is adjusted so that three stopband notches are centered at three specific frequencies. If the notches for this elliptic-function filter are set correctly, then the filter's flatness in the passband and its rejection throughout the stopband should be adequate.

The adjustment is made to the A3 or A10 Output Assembly. If the instrument has only one Output Assembly (A3), the adjustments are made only to it. If the instrument has Option 002 with two Output Assemblies (A3 and A10), adjustments are made to one or both assemblies. Accessing A3 will require extra disassembly. If the instrument has Option 006 (balanced output), adjustments are made on the A3 assembly with the balance transformer disconnected.

Equipment

Network Analyzer HP 3577A

NOTE

A spectrum analyzer with a tracking generator that covers 0 to 5 MHz is also suitable.

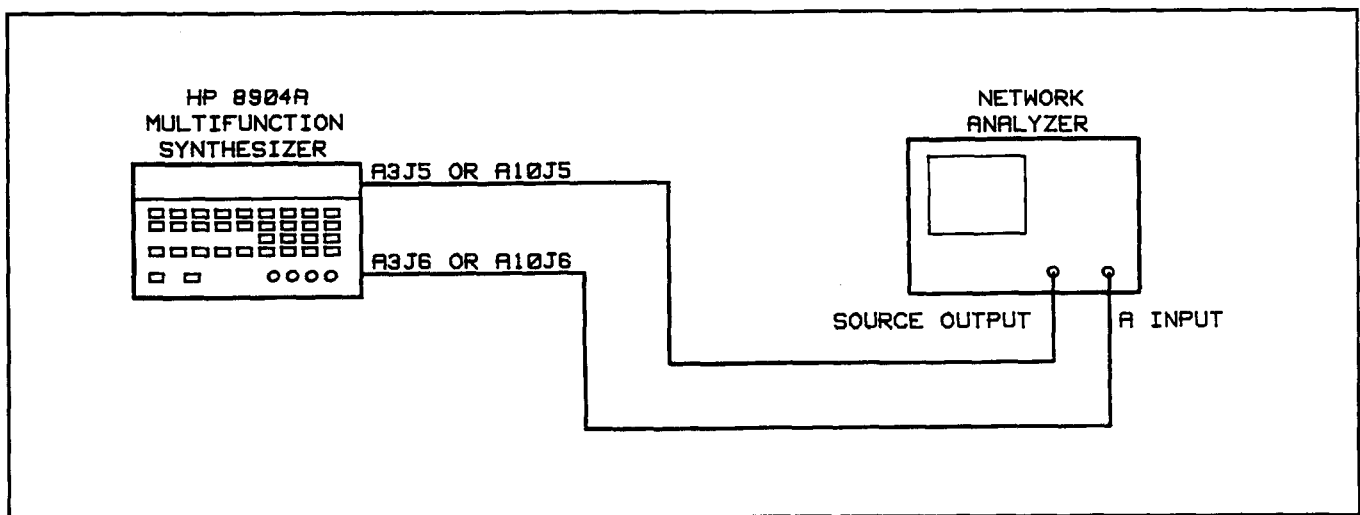

Figure 5-1. Sharp Cutoff Filter Adjustment Test Setup

Procedure

1. Turn the Multifunction Synthesizer's LINE to OFF and unplug the power cord. (It can remain unplugged throughout the test.) Remove the instrument's bottom cover.
2. If the instrument has Option 002 (a second output assembly) and Output 1 (the output from the A3 Output Assembly) is to be adjusted, move the A10 Output Assembly out of the way. (Refer to the disassembly procedure in Figure 5-4.)
3. If the instrument has Option 006 (balanced output), disconnect the coax cable from A3J400 (OUTPUT HIGH) at the front edge of the A3 assembly. In the steps that follows, when a reference is made to the OUTPUTS 1 HIGH connector, make the connection to A3J400 instead.

4. Move jumpers A3J3 or A10J3 and A3J7 or A10J7 to the opposite pins (that is, so that the jumper plug shorts the center pin and the opposite outer pin of the circuit board jack). (Refer to the Component Locator, Figure 5-6.)
5. Connect the equipment as shown in Figure 5-1. The network analyzer connects to two SMC connectors on A3 or A10. The network analyzer should be set up to drive the Sharp Cutoff Low-Pass Filter (at A3J5 or A10J5) with its source and to measure the output from the filter (at A3J6 or A10J6).
6. Set the network analyzer as follows:
 - a. Set the frequency to sweep linearly from 0 to 5 MHz.
 - b. Set the vertical scale to log.
 - c. Set the source level to +10 dBm.
 - d. Set the input attenuation, and scale so that the passband of the displayed filter response is at the top of the display and the notch at approximately 1 MHz is not obscured by noise. Refer to Figure 5-2.
7. Set the resolution bandwidth to 100 Hz.
8. Set the network analyzer's center frequency and frequency span as indicated in the following table. For each setting adjust the indicated inductor so that the stopband notch is centered about the center frequency.

Network Analyzer Settings		Inductor to Adjust
Center Frequency (MHz)	Frequency Span (kHz)	
1.07	300	A3L8 or A10L8
1.29	300	A3L9 or A10L9
2.21	500	A3L7 or A10L7

9. Reconnect the two jumpers to their original positions.
10. Perform Adjustment 5, *Sine X/X Compensation*.

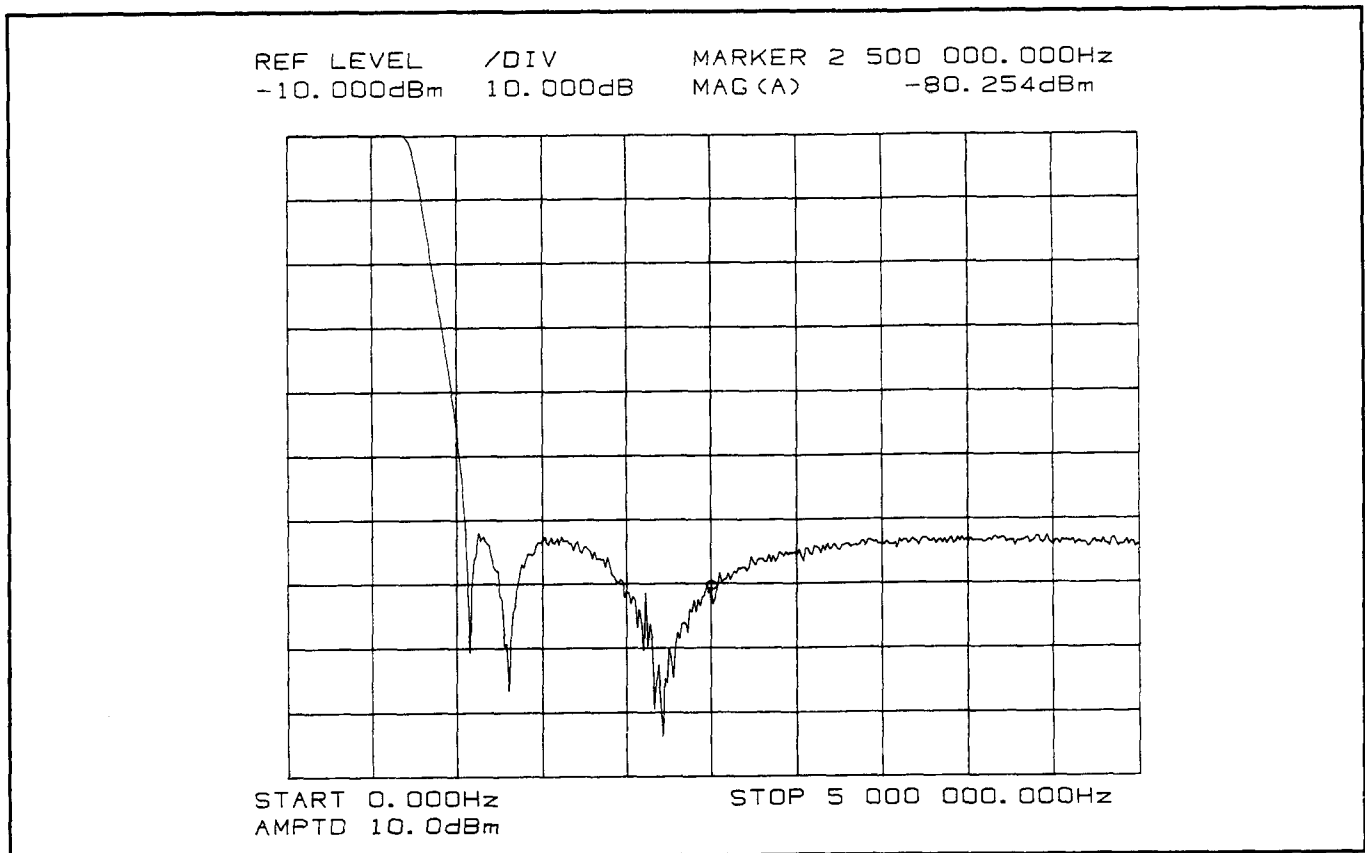

Figure 5-2. Typical Filter Response from 0 to 5 MHz

Adjustment 5

SINE X/X COMPENSATION

Description

The output of the Multifunction Synthesizer is connected directly to a thermal converter. The output of the converter (a dc voltage proportional to the rms input) is read on a digital voltmeter. A reference is determined with the Multifunction Synthesizer set to 1 kHz at 0.7 Vrms into 50Ω. The frequency is then changed to 550 kHz and the Sine X/X Compensation is adjusted for the same reading as at 1 kHz.

The adjustment is made to the A3 or A10 Output Assembly. If the instrument has only one Output Assembly (A3), the adjustments are made only to it. If the instrument has Option 002 with two Output Assemblies (A3 and A10), adjustments are made to one or both assemblies. Accessing A3 will require extra disassembly. If the instrument has Option 006 (balanced output), adjustments are made on the A3 assembly with the balance transformer disconnected.

Equipment

Digital Multimeter HP 3478A
 Thermal Converter HP 11050A or Ballentine Labs 1395A-1



The thermal converter is susceptible to burnout if more than 1 Vrms is applied to its input. Be careful when changing the frequency of the Multifunction Synthesizer that the amplitude does not inadvertently exceed 1 Vrms (a displayed setting of 2.8 V on the Multifunction Synthesizer).

Procedure

1. Perform Adjustment 4, *Sharp Cutoff Low-Pass Filter* first.
2. On the Multifunction Synthesizer, press SHIFT PRESET. After the instrument presets, key in
 f1 (Channel Config.)
 NEXT
 SHIFT FLOAT 1 OFF
 AMPTD 2 V
3. If the instrument has Option 006 (balanced output), disconnect the coax cable from A3J400 (OUTPUT HIGH) at the front edge of the A3 assembly. In the steps that follows, when a reference is made to the OUTPUTS 1 HIGH connector, make the connection to A3J400 instead.
4. Connect the ac input of the thermal converter to the Multifunction Synthesizer's OUTPUTS 1 HIGH output for the A3 Output Assembly or OUTPUTS 2 HIGH for the A10 Output Assembly. Connect the dc output of the thermal converter to the input of the voltmeter. Refer to Figure 5-3.

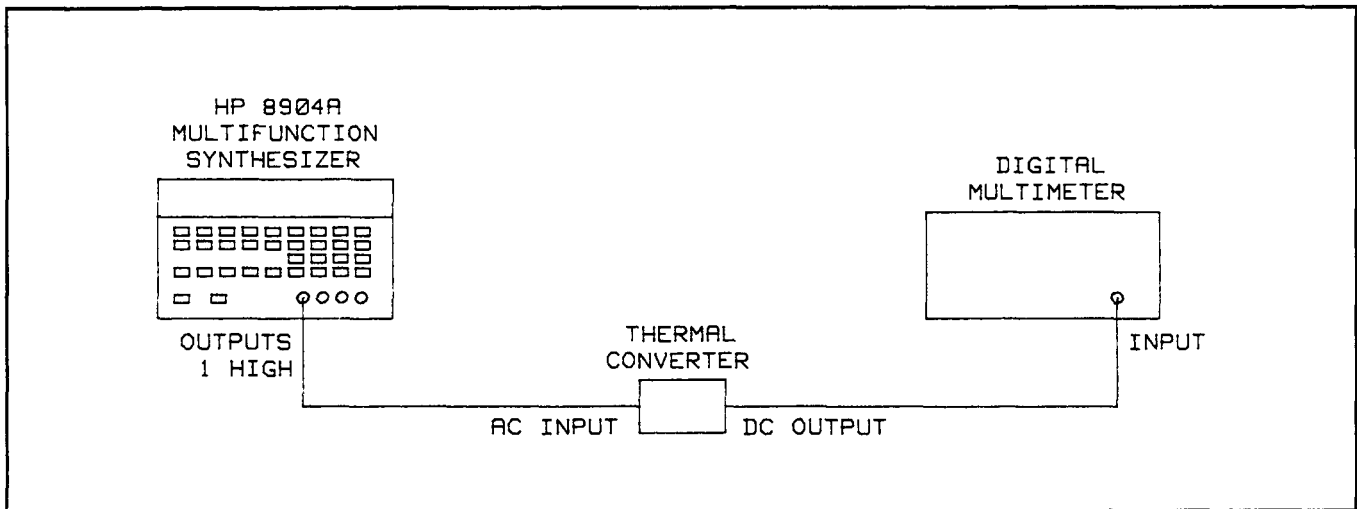

Figure 5-3. Sine X/X Compensation Adjustment Test Setup

5. Switch the voltmeter to measure dc volts on a 10 mV range. Read and record the voltage. (The voltage should be about +3.7 mVdc.)

1 kHz Reference: _____ mVdc

6. On the Multifunction Synthesizer, key in **FREQ 550 kHz**. Adjust A3L11 or A10L11 for the same reading as in step 5. Allow several seconds for the level reading to stabilize.

Adjustment 6

DISPLAY BACKLIGHTING AND CONTRAST

Description

The instrument's display is adjusted for most pleasing backlighting and character contrast. Any setting of the two adjustments is permissible; however, brightest backlighting may reduce the display's lifetime somewhat (which is why the backlighting was designed to time out 3 minutes after the last key is pressed).

Procedure

1. Remove the instrument's top cover. The cover may be tightly secured in the groove of the bottom cover. If the top cover does not pull off easily after backing out the screw on the rear edge, back out the screw on the rear edge of the bottom cover also. Place the instrument as it will normally be used (for example, in a rack or sitting on a table with its tilt stands down).
2. On the Multifunction Synthesizer, if the display backlighting is not on, press LOCAL. Adjust A2R36 (80V) for the most pleasing backlighting intensity. If the backlighting times out and goes off, press LOCAL again. (Refer to the Component Locator, Figure 5-5.)
3. Adjust A2R32 (DISPLAY CONTRAST) for the most pleasing character contrast (that is, the intensity of the characters to the background). Make the adjustment with the backlighting as it will normally be used.

Adjustment 7

PHASE SYNCHRONIZATION (OPTION 005)

Description

When two or more Multifunction Synthesizers are chained together in a master/slave arrangement, the synchronization between the slave and master clock and slave and master phase-reset outputs is critical. Errors in timing contribute directly to the unit-to-unit phase error. The slave and master delays are adjusted to the same nominal value to bring the phase error within specification. Delay adjustments are made in discrete steps by setting switches. The duty-cycle of the clock is adjusted by a potentiometer.

NOTE

This adjustment has no effect on instruments without Option 005. If the instrument has Option 005, this adjustment should be made only when there is strong reason to suspect a synchronization problem between Multifunction Synthesizers. The nature of the adjustment and lack of circuit diagrams make it difficult to understand what is happening. The factory settings should remain valid for the life of the instrument even when the A2 Controller Assembly has been repaired or replaced due to a fault elsewhere on the assembly.

If a synchronization problem is suspected, run Performance Test 11, Unit-to-Unit Phase Accuracy. If the test fails, check the relative delay between test points A2TP1 on the two Multifunction Synthesizers. The delay difference should be less than 15 ns. If this test passes, check for a channel-to-channel or Output 1-to-Output 2 phase accuracy problem.

Equipment

Oscilloscope	HP 1740A or Tektronix 2235
Power Splitter, Four Way	Mini-Circuits ZSC-4-3
Probe (2 required)	HP 10434A

Procedure

Initial Setup

1. Remove the instrument's top cover. The cover may be tightly secured in the groove of the bottom cover. If the top cover does not pull off easily after backing out the screw on the rear edge, back out the screw on the rear edge of the bottom cover also.
2. Connect the equipment as follows.
 - a. On the Multifunction Synthesizer, connect the rear-panel SYNC CLOCK OUTPUT to the input of the power splitter. Connect the rear-panel SYNC CLOCK INPUT to one of the outputs of the splitter. Use short cables. Terminate the other splitter outputs with 50Ω loads. (A 6 dB pad can be substituted for the splitter.)
 - b. Connect test point A2TP1 to channel A of the dc coupled oscilloscope using a low-capacitance, divide-by-10 probe. (Refer to Figure 5-5B for A2 assembly component locations.)

NOTE

To minimize ringing on the signal pulses, use low-capacitance, divide-by-ten probes. Test points A2TP6 and TP7 are provided for convenient grounding of the probes.

For purposes of timing, consider 0.1 V at A2TP1 to be the threshold of a logical high. For the other test points, consider 1.3 Vdc to be the threshold of a logical high.

- c. Connect test point A2TP5 to channel B of the dc coupled oscilloscope using a divider probe.
3. On the Multifunction Synthesizer, press SHIFT PRESET. After the instrument presets, key in
 SHIFT SPECIAL 7 ENTER
 f2 (Status) ON
 LAST
 f2 (Status) ON
 f4

Adjusting A2R105

4. On the Multifunction Synthesizer, adjust potentiometer A2R105 for a high period of 45 ns on the 13 MHz (clock synchronization) signal displayed on channel B of the oscilloscope.

Adjusting A2S2

5. Connect channel B of the oscilloscope to A2TP2.
6. On the Multifunction Synthesizer, toggle the switches on array A2S2 one at a time until the positive-going edge of channel B lines up with every other positive-going edge of channel A. (The frequency of channel B is one-half the frequency of A.)

NOTE

When setting the delay switches, only one switch in an array should be closed at a time; therefore, when changing switch settings open the currently closed switch before closing the desired switch.

Set the switches to the settings that give the result nearest the desired value.

Adjusting A2S4

7. Move the probe of channel B to test point A2TP5. Note the time delay between the positive-going edges of the signals on channel A and channel B.

Delay Between Signals at A2TP1 and A2TP5: _____ ns

8. Subtract 35 ns from the delay measured in step 7. (If the difference is negative, use 0.)

Computed Delay: _____ ns

9. Move the probe of channel B to test point A2TP4.
10. On the Multifunction Synthesizer, toggle the switches on array A2S4 one at a time until the positive-going edges of the signal on channel B lag the positive-going edges on A by the delay computed in step 8 to within ± 7 ns.

Adjusting A2S3

11. Move the probe of channel B to test point A2TP3. Toggle the switches on array A2S3 one at a time until the positive-going edge of channel B lags the positive-going edge of channel A by 48 to 62 ns.

Tools:

No 2 Pozidriv Screwdriver

Needlenose Pliers

PC Board Extractor

(included with Service Manual
or order: HP 08904-00013)

1. Turn instrument off, unplug power cord and remove bottom cover.
2. Disconnect ribbon cable, W17, from A10J1.
3. Remove hold-down screw and washer from center of A10 Output Assembly using Pozidriv screwdriver.
4. Pull A10 from each of its seven mounting posts. Release each mounting post by compressing the holding tang on mounting post with needlenose pliers while applying gentle upward pressure with the PC board extractor. (Extractor should exert pressure on metal shield, not on PC board, except where post does not extend through shield.)
5. Lift A10 from instrument and carefully lay A10 aside (coax cables will still be connected).
6. Replace hold-down screw (from step 3) with spacer (found under A10) into mounting hole in center of A3. This screw must be in place during adjustment procedure for A3.

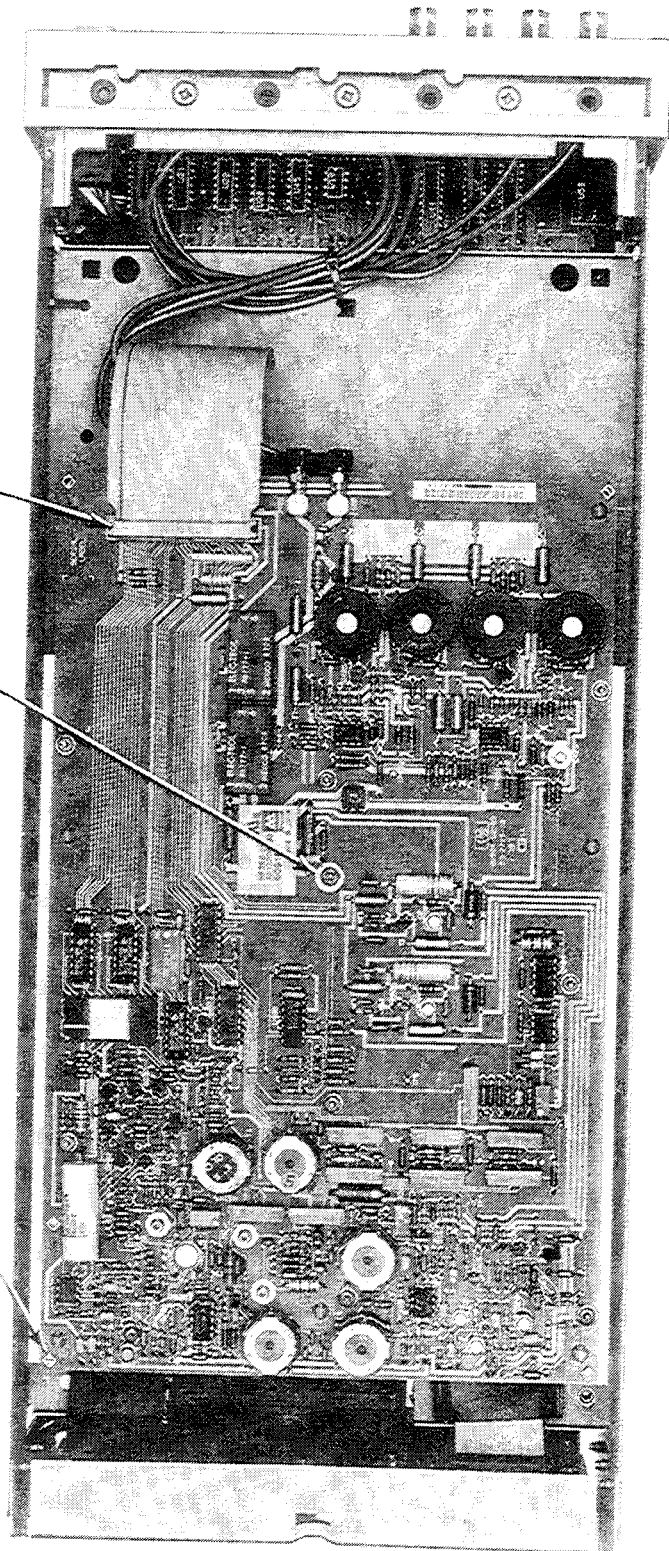

Figure 5-4. How to Access A3 in Instruments Equipped with Option 002

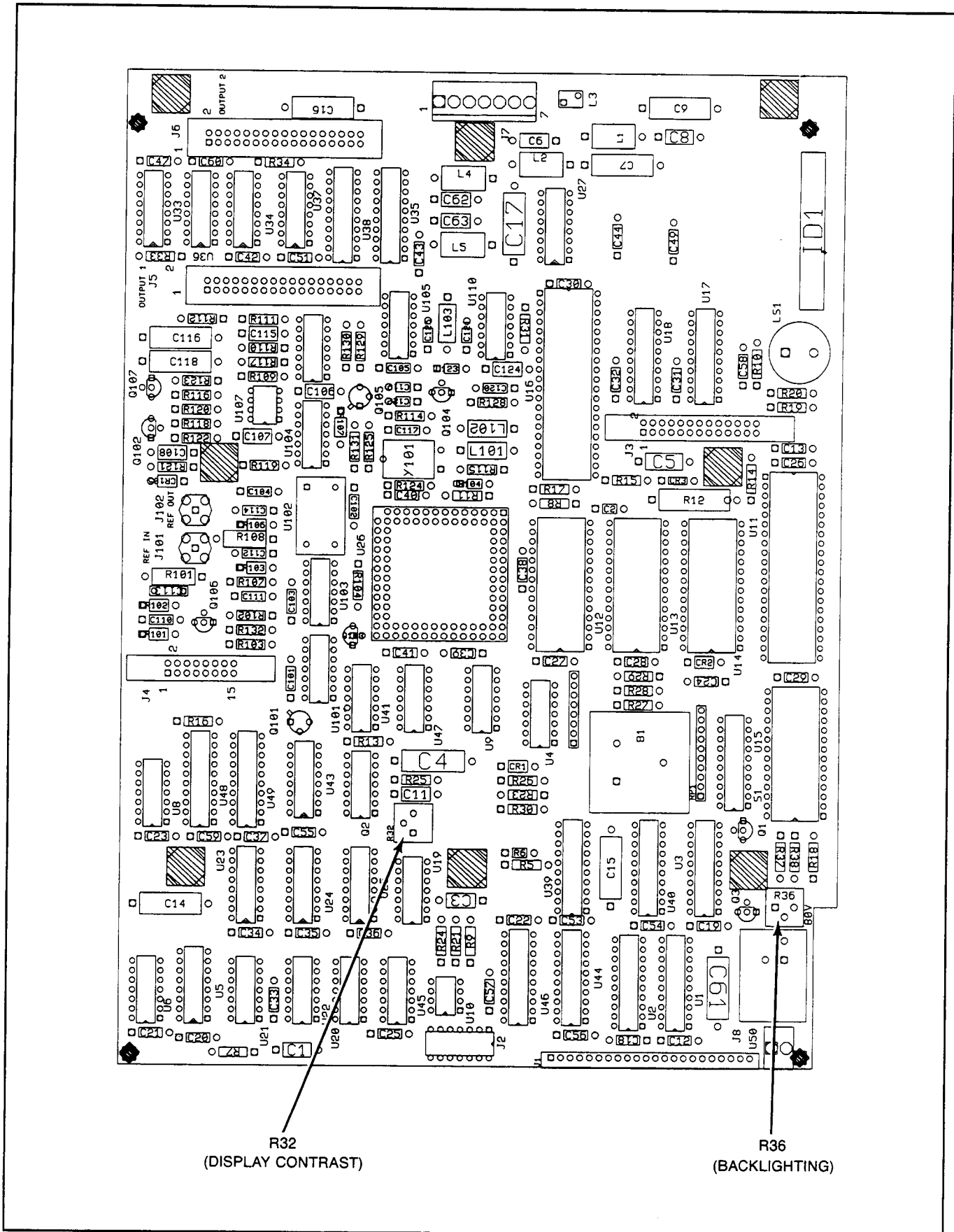

Figure 5-5A. Adjustment Locations for A2 (Serial Prefix 2942A and below)

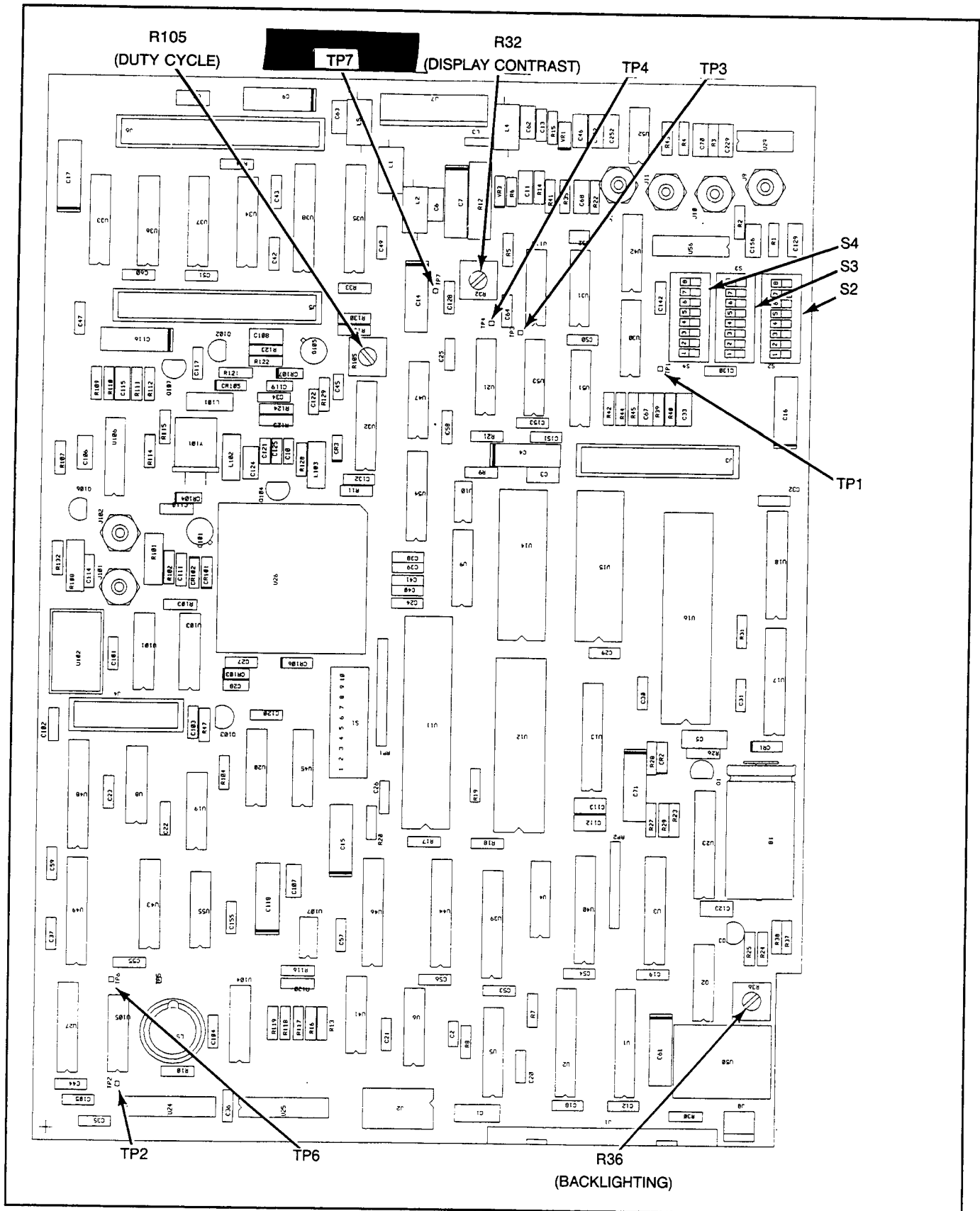

Figure 5-5B. Adjustment Locations for A2 (Serial Prefix 2948A and above)

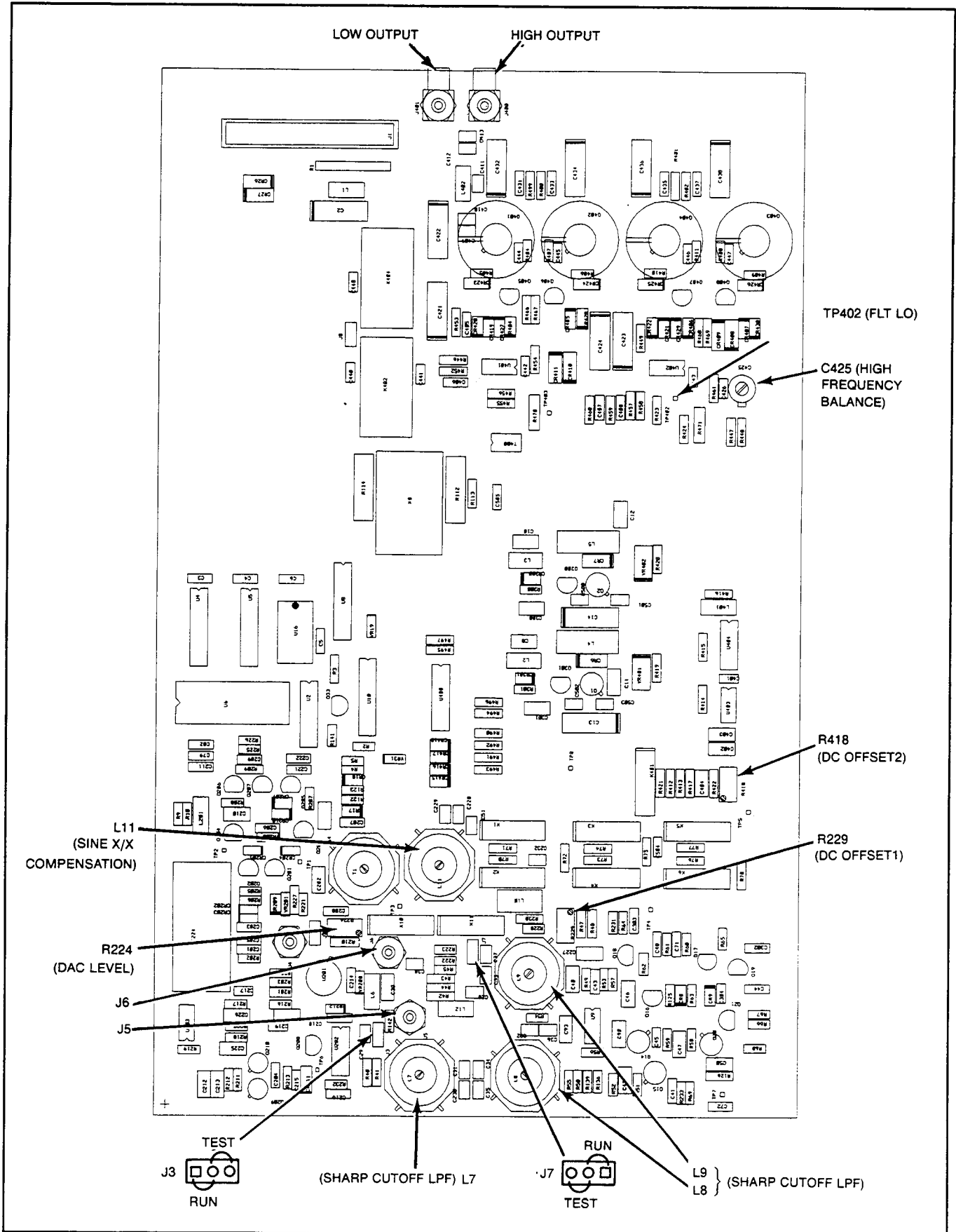

Figure 5-6. Adjustment Locations for A3 and A10